

THIS BOOK IS PRESENTED BY THE
GOVERNMENT OF THE UNITED STATES OF
AMERICA AS AN EXPRESSION OF THE FRIEND-
SHIP AND GOOD-WILL OF THE PEOPLE OF THE
UNITED STATES TOWARDS THE PEOPLE OF
INDIA.

तमसो मा ज्योतिर्गमय

SANTINIKETAN
VISWA BHARATI
LIBRARY

L. C

355 (T)

Ae 62

THE LOEB CLASSICAL LIBRARY

FOUNDED BY JAMES LOEB, LL.D.

EDITED BY

† T. E. PAGE, C.H., LITT.D.

E. CAPPS, PH.D., LL.D. W. H. D. ROUSE, LITT.D.

L. A. POST, M.A. E. H. WARMINGTON, M.A.

AENEAS TACTICUS

ASCLEPIODOTUS

ONASANDER

**AENEAS TACTICUS
ASCLEPIODOTUS
ONASANDER**

**WITH AN ENGLISH TRANSLATION
BY MEMBERS OF
THE ILLINOIS GREEK CLUB**



**CAMBRIDGE, MASSACHUSETTS
HARVARD UNIVERSITY PRESS
LONDON
WILLIAM HEINEMANN LTD
MCMXVIII**

First printed 1923
Reprinted 1943

Printed in Great Britain.

CONTENTS

AENEAS TACTICUS—

	PAGE
PREFACE	ix
INTRODUCTION	1
TEXT	26

ASCLEPIODOTUS—

PREFACE	229
INTRODUCTION	230
TEXT	244
LIST OF TECHNICAL TERMS	334

ONASANDER—

PREFACE	342
INTRODUCTION	343
TEXT	368

INDEX	529
-----------------	-----

AENEAS TACTICUS

PREFACE

EARLY in 1917, *Marte iam diu furente*, the attention of the Faculty Greek Club of the University of Illinois was turned toward the art of war, in which, as in so many other fields of scientific and humanistic interest, the Greeks achieved results of more than transitory value. The military manual of Aeneas, styled the Tactician, suggested itself as a monograph in this field well suited for discussion by such a club, and portions of this treatise were accordingly translated by the following members : J. C. Austin, E. C. Baldwin, H. J. Barton, L. Bloomfield, H. V. Canter, M. J. Curl, F. K. W. Drury, S. Engel, H. S. V. Jones, J. W. McKinley, C. M. Moss, W. A. Oldfather, A. F. Pauli, A. S. Pease, R. P. Robinson, C. A. Williams, and J. Zeitlin. Of the versions thus produced a number were discussed and criticized at a series of meetings, and all were subsequently revised and edited by Messrs. W. A. Oldfather, A. S. Pease, C. M. Moss, and H. V. Canter. An

AENEAS TACTICUS

introduction, critical apparatus, notes, and index have been added to make the work conform to the general plan of the Loeb Classical Library.¹

¹ The introduction, the preparation of the text, and the notes have been the work of W. A. Oldfather; the text and translation of the excerpts from Julius Africanus have been made jointly by Messrs. Oldfather and Pease.

INTRODUCTION

OF Aeneas, commonly known, since Casaubon's time, as the Tactician, little is recorded, and not much more may be with a fair degree of probability inferred from the treatise before us. Mr. T. Hudson Williams very properly insists upon the scantiness of our direct evidence that Aeneas was actually the name of the author of this military handbook, and upon the necessary uncertainty that attaches to all arguments based upon conjecture only. But after all, the evidence, though not amounting to demonstration, has unusual cogency, and little of our knowledge regarding the minor authors of antiquity can be regarded as resting upon a firmer basis of attestation and inference. The case for Aeneas may be put thus.

It is true that the ms. superscription runs *Αἰλιανοῦ τακτικὸν ὑπόμνημα περὶ τοῦ πῶς χρῆ πολιορκουμένων ἀντέχειν*, 'Aelian's tactical treatise on how men in a state of siege should resist'; but the ascription to Aelian is absurd, partly because of the utmost difference in style between this tractate and Aelian's other work, but more especially because it contains not a single historical reference to an event that occurred within four centuries of Aelian's time.

AENEAS TACTICUS

Again, *τακτικὸν ὑπόμνημα* is an impossible designation for the work of Aeneas, if for no other reason, because it contradicts his own definition of tactics, quoted by Aelian iii. 4, as *ἐπιστήμην πολεμικῶν κινήσεων* 'science of military movements,' of which there is hardly a trace in the present work. The length of the remainder of the title, furthermore, when compared with the brief designations by which the author refers to his other works, shows clearly that this latter part does not belong to the original superscription. If we bear in mind, finally, that in the sole authoritative ms.¹ this treatise follows the work of Aelian, the conclusion is unavoidable that the superscription derives from a misapplied subscription to Aelian, to whose treatise the words *τακτικὸν ὑπόμνημα* exactly apply. The subscription to our work runs *Αἰνείου πολιορκητικά· ἢ Αἰλιανοῦ καθὼς ἢ ἀρχή* (followed by an erasure of thirteen letters), 'Aeneas on Siege Operations; or Aelian as at the beginning.' Here we clearly have to do with a bit of genuine tradition, followed by a corrective note intended to bring the conjectural superscription and the traditional subscription into harmony. Direct ms. evidence, accordingly, where it possesses any substantial authority, assigns our treatise to an Aeneas. Whether, however, *πολιορκητικά* was the author's own designation for his book may be doubted, partly because, in referring to his other works, he generally uses an adjective with the word *βίβλος*, and partly because this manual contains almost no advice about how to besiege a town,

¹ And so probably in the collection of military writers dating from early Byzantine times, for M seems to have been copied from an uncial ms.

INTRODUCTION

which is the only meaning of *πολιορκέω* and related words.

Accepting the unimpeachable *ms.* testimony to authorship by Aeneas, we may now compare the internal evidence offered by the work itself with what is known from other sources about the military writer Aeneas.

Beginning with the latest and the least specific, Johannes Lydus, *De magistratibus*, i. 47, in the sixth century of our era,¹ mentions along with five others an Aeneas as an authority upon *πολιορκητικά* or 'Siege Operations.' Aelian, *Tactica*, i. 2, in the second century after Christ, mentions Aeneas as the first military writer (after Homer, to be sure) who composed *στρατηγικὰ βιβλία ἱκανά*, 'a considerable number of military manuals,' which Cineas the Thessalian (an associate of Pyrrhus of Epirus) epitomized; and in iii. 4, Aelian quotes his definition of tactics as *ἐπιστήμην . . . πολεμικῶν κινήσεων*, 'the science of military movements.' Polybius, x. 44, inveighs in a characteristic vein against the recommendation of an Aeneas, *ὁ τὰ περὶ στρατηγικῶν ὑπομνήματα συντεταγμένος*, 'who composed treatises on military science,' with regard to signal fires.²

The conclusion from this evidence is that an Aeneas, living before the time of King Pyrrhus, composed a number of treatises on military science, among them works on tactics and siege operations, and discussed signal fires. All this agrees perfectly with the internal evidence of the treatise itself,

¹ For some reason omitted by Schöne in his *testimonia*.

² The brief note in the lexicon of Suidas (tenth century), under the lemma *Αἰνείας*, seems to be taken entire from Polybius.

AENEAS TACTICUS

which deals with siege operations, particularly from the side of the defence, and which several times mentions signal fires, the very passage of which Polybius speaks being cited from another work in ch. 7. 4. Furthermore, the author frequently refers to other writings of his on military science, and the first sentence of a book on naval operations is contained in the ms. at the end of the present treatise, so that, even without the evidence of the subscription, there can hardly be a justifiable doubt that ours is the work of the Aeneas whom Polybius, Aelian, and Johannes Lydus mention. The argument derives additional support from Fr. Haase's happy emendation in 31. 18, where the author, as would be not unnatural, chooses his own name as a sample with which to illustrate a system of cryptographic writing. To be sure, the account of the operation breaks off after spelling out *αυυε*, but one can hardly avoid the conclusion that *Αἰνεάων* or *Αἰνεών* (for the accusative is required) originally stood in the text. Mr. Williams, indeed, pronounces the verdict 'not proven,' but he seems to demand a completeness of demonstration which can seldom be secured in things philological, and with this single exception Haase's emendation has been generally approved.

Aeneas gives abundant evidence of first-hand acquaintance with his subject and an experience in military operations which, though extensive, is almost wholly confined to the geographical limits of the Peloponnesus and the western coast of Asia Minor (with the adjacent islands). He seems, accordingly, to have served in these two fields, and as few Asiatic Greeks were drawn to the Peloponnesus,

INTRODUCTION

while thousands of Peloponnesians, and especially Arcadians, served as *condottieri* in the East, it can hardly be doubted that Aeneas was a Peloponnesian who had seen service in the Aegean and in Asia Minor.¹

Regarding the period in which Aeneas wrote, it has been observed that more than half his historical examples fall within the years 400–360 B.C., and that their number becomes greater as one approaches the latter date. Thus incidents are cited for 397, 382, 379, 370, 369, 368, 363, 362, 361, and close with the capture of Ilium by Charidemus in 360. On the other hand the book was written before 346, because it represents the Locrians as still sending maidens to Ilium, a custom which Timaeus² tells us ended at that time. We can, therefore, with a high degree of certainty place the composition in the years just following 360, because neither Philip of Macedon nor the stirring events of the Phocian war (356–346) are mentioned. Indeed it is extremely probable that Aeneas composed his manual in 357–356. Alfred von Gutschmid has pointed out Aeneas's habit of illustrating his point by the most recent events, and with that in mind the two specimens of secret messages *Διονύσιος καλός*: *Ἡρακλείδης ἤκέτω* (as given by M). 'Dionysius is fair; let Heracleides come,' in 31. 31, can hardly refer to anything but the war between Dionysius II of Syracuse and Dio and Heracleides operating from the Peloponnesus in

¹ The utter neglect of Athens as well as the employment of occasional non-Attic idiom and vocabulary make it almost certain that he was not an Athenian.

² Preserved in the scholia to Lycophron v. 1144 (Scheer's edition).

AENEAS TACTICUS

357.¹ Heracleides, it may be noted, remained behind for a while and came on after Dio with a few warships and a considerable force of men. Now the use of the singular form *τόδε* in the text and the absence of a connective between the first two and the last two words make it evident that we have here to do with a single message, whereas no one who ordered Heracleides to follow could possibly be speaking in a favourable manner of Dionysius. A further touch of verisimilitude is furnished by the use of the Syracusan (Doric) dialectal form *Ἡρακλείδας*, the very way in which Dio would have addressed Heracleides, although Aeneas himself is writing in Attic-Ionic, and consistently avoids Doricisms. *καλός* accordingly must be changed to agree with the remainder of the message, and here Hermann Schöne's emendation *κόλος*, 'docked' or 'dehorned,' used of an ox or goat which had been rendered harmless, is an apt expression, equivalent to our English phrase 'with one's wings clipped,' or 'shorn of one's locks.' Considering also that *κόλος* was actually used in military parlance of an indecisive or interrupted engagement, witness the *κόλος μάχη* of the *Iliad*, Book viii, and that the corruption to *καλός* is easy in view of the commonness of this formula in dedications and inscriptions of many kinds, it may be accepted as highly probable that Aeneas is here giving an actual or supposititious message, very likely from Dio himself, to Heracleides in Greece, ordering him to follow, since Dionysius had lost his power and was no longer dangerous.² This message

¹ For the details of which one may refer to A. Holm, *Geschichte Siziliens*, ii. 177 ff.

² This corresponds exactly with the facts. Dio set out

INTRODUCTION

was sent in the fall of 357, very shortly after which the present treatise was probably written.

Casaubon thought that our Aeneas might be identical with the Aeneas of Stymphalus in Arcadia, who, as general of the Arcadian League, in 367 B.C. drove out Euphron the tyrant of Sicyon with the help of Sicyonian exiles (Xenophon, *Hellenica*, vii. 3. 1). This suggestion, which has been elaborated by Hug, has been very widely, although not universally, accepted, and in view of the converging lines of evidence from several different quarters, the discussion of which here, however, would take us too far afield, may be regarded as probably correct, although it is perhaps unwise to call our author outright 'Aeneas of Stymphalus' as does Hug.

In its general literary setting the work of Aeneas belongs to the type of the didactic handbook which began to appear toward the end of the fifth century, under the influence of the Sophists and Socrates.¹

against Dionysius II with scarcely eight hundred men, a ridiculously small number in comparison with the enemy. "But Dio was justified in his belief that the ruler's power was crumbling and that he had completely undermined it," as Eduard Meyer, *Geschichte des Altertums*, v. 513, expresses it.

Hermann Diels and, independently, Herbert Fischer, conjecture *κακῶς*, which requires something more of a change than *κόλος*, for M, and probably its predecessor, had only KAC. Diels speaks of a telegram of the younger Dionysius to Heracleides, but it seems more reasonable to suppose that Dio sent the message, because, although Dio and Heracleides eventually fell out, they were both in exile in Greece in 357 B.C., and it was Heracleides' victory over Philistus in the sea-fight the next year which finally compelled Dionysius to flee.

¹ Examples of which from this same period we have in Xenophon's essays *On Horsemanship* and *On the Duties of a Cavalry Commander*.

AENEAS TACTICUS

His literary work, which Polybius sums up under the general title *στρατηγικὰ βιβλία*, 'Works on military Science,' was divided into a series of special monographs. Aeneas himself refers to five: (1) *ἡ παρασκευαστικὴ βίβλος* (7. 4, etc.), 'Treatise on military Preparations'; (2) *ἡ ποριστικὴ βίβλος* (14. 2), 'On (War-)Finance'; (3) *ἡ στρατοπεδευτικὴ βίβλος* (21. 2), 'On Encampments'; (4) *<ἐπιβουλῶν?> βίβλος*, 'On Plots' (11. 2, see the apparatus criticus at this point); and (5) *ἀκούσματα* (38. 5). This last title has been variously understood, either as 'Historical Illustrations' (Casaubon, Mahlstedt), 'Lectures' (Christ-Schmid), or 'Admonitions' (Köchly, Hug, and others), of which the last suits the context best, besides being supported to some extent by Isocrates' use of the word (*Ad Demonium*, 12 and 17), which he paraphrases by *σπουδαῖοι λόγοι* and *σοφίαι*. Besides these the ms. contains at the end a fragment of what Aeneas himself calls (6) a *ναυτικὴ τάξις*, or a work 'On naval Tactics.' That this was an independent monograph has been doubted by Hug, but upon insufficient grounds. Such a treatise was essential to a well rounded scheme of manuals on military science, since nowhere in the world has so large a part of warfare been necessarily waged upon the water as in Greece. We must also assume the existence of a special treatise (7) 'On the Conduct of Siege Operations,' a *πολιορκητικὴ βίβλος*, partly because Aeneas was subsequently listed among the poliorketic writers, whereas the present treatise deals exclusively with the defence of fortifications, but especially because the introduction to the present monograph, when considered as but a chapter in a comprehensive treatise on military science, by its

INTRODUCTION

emphatic contrast of the relative positions of the attacker and the defender, clearly indicates that the conduct of siege operations had already been treated.¹ Last is (8) a τακτικὴ βίβλος, or τακτικά, 'On Tactics,' to which Aelian refers, and from which he quotes the definition of tactics as given above. Into this general scheme of military manuals the present treatise would fall most naturally as a counterpart to the πολιορκητικὴ βίβλος, if it be not actually the second half of that work, to which the introductory sentence makes such direct reference. This supposition would also relieve us of the necessity of restoring by conjecture an otherwise unknown adjective to agree with βίβλος as a title for this treatise. A general work treating of both the offensive and the defensive in time of siege might, without too great impropriety, be called a πολιορκητικὴ βίβλος 'On the Conduct of Siege Operations,' but the second part alone could not be designated by that title. As regards chronological order, it is obvious that Nos. 1, 2, 4, and 5 preceded the present treatise because they are referred to as already written. Also, according to our hypothesis, No. 7 immediately preceded, just as No. 6 followed. No. 8 is in no place referred to, even where, as in 1. 2, such a reference would have been most appropriate. It was probably, therefore, planned and composed after this book was written. No. 3, on the other hand, although not yet written, was clearly planned, and, as is natural, the author is more ready to introduce a few topics from it into his present work

¹ The parallel with the ναυτικὴ τάξις which is bipartite also suggests that the present treatise was cast in the same form, as Fischer suggests.

AENEAS TACTICUS

than from a treatise which had been published and was already known.

Literary sources of a direct kind did not exist for Aeneas, and his account is mainly drawn from experience and from oral tradition. Herodotus is occasionally used for illustrations, Thucydides once only (for the siege of Plataea); but Aeneas was under the influence of the latter's vocabulary and style. Xenophon's *Anabasis* may have been drawn upon for the anecdote of how a panic was stopped by a clever joke (27. 11), but there is a marked variation in detail and the same anecdote is elsewhere ascribed to Iphicrates. Von Gutsehmid thought that Ephorus was used occasionally, but that is doubtful.

The title of the present treatise, as already noted, has probably been lost; the latter part of the superscription, however, we retain, enclosing it in brackets, as the best designation that has come down, and use as a translation of it the somewhat conventionalized title, 'On the Defence of fortified Positions,' the equivalent of which in Latin, German, or French has become sanctioned by general usage and is essentially correct.

Our treatise shows evidence of systematic planning, and although certain paragraphs, or even chapters, might appear somewhat more logically in a different connexion, and some of the transitions are not well marked, Kirhhoff's theory of wholesale displacement is certainly wrong.¹ The following are the general divisions of the subject :

¹ Fischer's recently proposed explanation, namely that Aeneas was engaged upon this from 379 to 356 B.C., constantly revising his lecture notes and adding references to the most

INTRODUCTION

- I. On selecting and disposing troops and on preparing positions in and about the city for facilitating the defence (1-10.24).
- II. On maintaining morale and discipline and general measures for thwarting treachery and revolution (10.25-14; phases of this latter topic are considered in a number of other chapters).
- III. On repelling sudden forays (15-16.15).
- IV. On checking, at a distance from the walls, the advance of a foe, and on taking special precautions in regard to religious processions outside the city walls and treachery at the gates of the city (16.16-20: 21 is transitional).
- V. On guarding the walls by night and by day and preventing smuggling of arms to revolutionary factions and their direct communication with the foe (22-31).
- VI. On means to meet the actual assault of the foe upon the fortifications (32-40).

It may be said of the measures recommended by Aeneas that many of them seem to us simple, a few almost trivial. But the same is true of the elements of all great inventions which have become part of our thought and action. Even the somewhat naïve

recent happenings as illustrative material, is not likely to win general assent. The case of Aristotle's *Metaphysics* is very different. There is nothing to show that Aeneas was a school lecturer and it is difficult to picture him in that capacity.

AENEAS TACTICUS

cryptogram in 31. 31 which called forth von Gutschmid's scorn, though hardly likely to deceive any military censor today, might well have imposed upon a simple-minded gateman or upon barbarian police, at a time when all reading was uncommon, writing none too easily legible, and tricks with vowels and consonants well-nigh unheard of even among the learned.¹ Military science in the hands of its great masters is still a simple thing. Battles and campaigns are won and lost, as the annals of the great strategists show, by the observance or neglect of such elementary considerations as rapidity of motion, concealment of purpose, concentration of a superior force at the point of impact, and the like,² which anyone can appreciate and which seem almost too trivial for formal statement. 'Ἀπλοῦς ὁ μῦθος τῆς ἀληθείας ἔφν—"Truth's story is by nature plain."

One ought rather to note the large number of devices which, although war has taken on such a different external aspect, even yet apply, such as censorship of letters, police prohibition of gatherings, putting out of lights, passports, exclusion or internment of suspicious aliens, special regulations for the surveillance of lodging-houses, interest moratoria and

¹ In this connexion it might be noted that precisely this very cryptogram was employed for the title of a mediaeval ms. in Rome, Cod. Roman. Bibl. Vitt. Em. 1369 (Sessorianus 43), s. xiii. L . . e . . br . . t . . nc . . : l . . g : d . . ; that is *Lucubratione Egidii*. (From Herr Sechel as reported by Diels, p. 29, note 4.)

² Thus it is reported of the Confederate General Forrest, that he summed up his military science in a single phrase in response to the question, how he won his successes: "I get there first with the most men."

INTRODUCTION

supertaxes on wealth, bonuses for importers of food and munitions, signals, trenches, mining and counter-mining, masks for protection against smoke and fire, secret methods of communication, and the employment of dogs. As the first writer upon military science Aeneas should always command the attention of students of that subject, so long at least as the necessity of defence against aggression devolves upon a watchful citizenship.

That the works of Aeneas were highly regarded is shown by the fact that early in the next century Cineas, the friend of King Pyrrhus, prepared an epitome of them, a thing that he would hardly have done except at the suggestion or with the approval of that great commander, who himself wrote a treatise upon the art of war. The true worth of Aeneas is better appreciated by the admiration of Pyrrhus, one of the world's half-dozen greatest captains, than by the strictures of any closet philologist. In the second half of the second century B.C. the fifth book of Philo the Mechanician upon the attack and defence of fortifications makes use of Aeneas. Polybius used his treatise on *Military Preparations*. Onasander towards the middle of the first century after Christ, Aelian early in the second century, and Polyaeus shortly after the middle of the same century, knew and made use of this work. Early in the third century Sextus Julius Africanus transferred bodily large portions of the present treatise to his *Κεῖρτοι*.¹ Traces of Aeneas's influence appear also in an anonymous Byzantine military writer of the sixth century, and possibly elsewhere.

¹ These excerpts will be found at the end of the present translation.

AENEAS TACTICUS

Probably about this time was composed the corpus of Greek military writers as represented in the Laurentian ms. at Florence, a ms. which alone saved to the modern world Aeneas and several other authors of this group.

In the nineteenth century the text of Aeneas passed through singular vicissitudes. Almost rediscovered for scholarship by Haase, Köchly and Rüstow, it was inevitable that a certain *furor philologicus* then raging should fall foul of it. The earliest editors had followed the ms. tradition wherever it could be understood, and had not attempted to prescribe how Aeneas ought to have expressed himself. With the greater refinement in the study of style and syntax which the nineteenth century achieved, but while the historical attitude had not gained the ascendancy, it happened more than once that a text was practically rewritten by a courageous but over-zealous philologist. Thus Rudolph Hercher in the early 'seventies, misapprehending the numerous non-Attic forms, strange syntax, and loose or redundant expressions in Aeneas, conceived the idea that a pure and succinct Attic text had been disfigured by an interpolator, and accordingly discarded about one-twelfth of the book. Arnold Hug went further in this direction, eliminating about one-fourth in order to secure a correct and elegant literary form, and even Adolph Lange, though defending the text with great acumen against many changes of interpolation, himself rejected approximately one-tenth of the whole. This was of course to reduce the process of emendation to the point of absurdity and a reaction inevitably followed. A theory of wholesale displacement of paragraphs and

INTRODUCTION

chapters, first suggested by Adolf Kirchhoff, had but a short vogue. No motive or occasion for such transpositions is conceivable, and the order of topics, although not in every instance the most logical, is on the whole satisfactory when one bears in mind that the author was neither a scientist nor an accomplished man of letters.

The increase in our knowledge of the changes in syntax, forms, and vocabulary brought about by the inscriptions and papyri discovered in the last few decades, and the greater attention paid to the language of others than the Atticists, has enabled us to form a truer judgement of the κοινή, or common Greek idiom, which was the universal means of literary communication in the Hellenistic period. The formation of this common idiom has now been traced back with certainty to the Delian league of the fifth century, and its basis is recognized to be a mixture of Attic and Ionic with elements, in greater or less proportion, from other dialects. As a fully developed literary style it makes its appearance shortly after the age of Alexander. but we now recognize that Aeneas is one of the very earliest documents preserved from the period of transition and development, and our duty is not to reduce his work to the standards of the strictest Attic prose of the fourth century, but to accept it as it has come down to us, emending only what is impossible in form and syntax, and endeavouring to understand rather than to transform the document. Mahlstedt's exhaustive lexicographical study of the vocabulary of Aeneas, and the more general treatment of his style by Behrendt, both appearing in 1910, reached the certain conclusion that Aeneas is a forerunner

AENEAS TACTICUS

of the *κοινή*. This sober historical point of view is also characteristic of Schöne's elaborate recension, which is the basis of the present text. Much remains yet to be cleared up in the interpretation of the subject matter, but the essential character of the language and style can now be regarded as finally determined.

In yet another aspect Aeneas supplies us with a valuable historical document, and that is in the light he throws upon the chaotic conditions that obtained in Greece during the severe social revolutions of the fourth century, which contributed perhaps more than any other single cause to the destruction of the fabric of early Hellenic civilization. The history of the time is full of the records of brutal revolution and bloody revenge. Plato has drastically characterized the oligarchic state as "not one but two States, the one of the poor, the other of the rich men; and they are living on the same spot and always conspiring against one another."¹ Again he depicts Greece as he knew it in a prophecy of what would happen should his ideal guardians "acquire houses and lands and moneys of their own. . . . Hating and being hated, plotting and being plotted against, they will pass their whole life in much greater fear of internal than of external enemies, and the hour of ruin, both to themselves and to the rest of the State, will be at hand."²

We have at times in this treatise what seems almost a commentary upon these passages from Plato in the matter-of-fact words of Aeneas, who like a professional soldier seems to have held aloof

¹ *Republic*, 551 E (Jowett).

² *Republic*, 417 A, B (Jowett).

INTRODUCTION

from the partisanships of politics, so that some who have failed to grasp his true attitude have regarded him as a moderate democrat and others as a supporter of oligarchy. More than half his military admonitions are directed towards preventing treachery and forestalling revolution. The men for whom he wrote his manual were clearly in constant danger of the enemy within their own gates, a peril which became more rather than less acute when armed foes without were threatening the very existence of the state. Upon one memorable occasion at Argos the revolutionary assassins carrying concealed daggers mingled with the officials and leading citizens at a religious festival outside the walls, and struck them down, each one his man, at the very moment of their devotions about the altar (17. 2 ff.). Paralyzing indeed must have been the terror in many a community in Greece when such occurrences were felt to be not merely possible but perhaps actually impending.

MANUSCRIPTS

Aeneas survived the Middle Ages in but a single ms., now preserved in Florence and the parent of all others known to exist. This is the famous Laurentianus Graecus LV 4, commonly called M (*i.e. Medicus*, described by Bandini, *Catal. Codd. MSS. Bibl. Laurent.* t. ii., 1768, 218-38). It contains the corpus of Greek military writers, a collection which no doubt dates from early Byzantine times. The three descendants of M are all in Paris, known respectively as A (Parisinus Graecus 2435), B (Parisinus Graecus 2522), and C (Parisinus Graecus 2443). Of these C, although the only ms. known to Casaubon, and hence the source of the *editio princeps*, is worthless, being descended from B or a copy of B, except in so far as some corrections of corrupt passages, introduced by its copyist, Angelus Bergelius, possess independent value as emendations. A and B, however, are not without critical worth, because M suffered somewhat from dampness after they were written and is in consequence quite illegible in places, besides containing a few lacunae which did not exist when the copies were made. They are cited only where the text of M is lost. Fortunately they were copied with unusual fidelity, so that almost nothing of the text of M, as it existed in the fifteenth century, is lost to us.

INTRODUCTION

For a considerable portion of Aeneas the excerpts included by Julius Africanus in his *Κεχροί* furnish an excellent check upon M, since they represent a tradition of Aeneas—rather seriously disfigured to be sure—which is seven or eight centuries older than that ms. A text of these portions of Africanus is furnished by R. Schöne in his edition of Aeneas, based in part upon materials collected by Fr. Haase and K. K. Müller, and in part upon his own collations. The most important readings in which Africanus differs from the tradition in M are given in our apparatus criticus as ms. readings.

Jacob Gronov was the first to use M as an aid in constituting the text of Aeneas. The peculiarities and characteristic faults of this ms. are best set forth in A. C. Lange, *De Aeneae Commentario Poliorcetico*, 58-65, and R. Schöne's edition, x f. Despite the bad state of the tradition and the abysmal ignorance of the scribe, the comparatively large number of places where a critical mark was written above words which were thought to be corrupt, and the blank spaces left where the original was illegible or defective, are evidence of the faithfulness with which the copy was prepared.

The chapter headings, although older than the third century of our era, because known to Africanus, can hardly have come from Aeneas himself. In deference to custom, and for the sake of convenience, they are retained, but enclosed in brackets, to indicate their later origin.

AENEAS TACTICUS

EDITIONS

- Is. Casaubonus : *Λινείου τακτικόν τε καὶ πολιορκητικὸν ὑπόμνημα περὶ τοῦ πῶς χρῆ πολιορκούμενον ἀντέχειν*. Paris, 1609. Text, notes, and Latin translation. This is the *editio princeps*, appended to Casaubon's edition of Polybius, and the whole republished by Jacob Gronov and by J. A. Ernesti in their editions of Polybius published at Amsterdam in 1670 and at Leipzig in 1763-64, respectively. Gronov later published from M (see below) *Supplementa Lacunarum in Aenea Tactico*, etc. Leyden, 1675.
- Jo. Conradus Orellius : *Aeneae Tactici Commentarius de toleranda Obsidione*, etc. Leipzig, 1818. This edition contains Casaubon's translation, together with notes of Casaubon, Gronov, Koës, Caspar Orelli, Conrad Orelli, and others. It appeared as a supplement to Schweighäuser's Polybius.
- H. Köchly und W. Rüstow : *Aeneas von Verteidigung der Städte*. Leipzig, 1853. Aeneas occupies a part of vol. i of the editors' well-known *Griechische Kriegsschriftsteller, Griechisch und Deutsch*. A supplement in vol. ii. 2, contains readings from B (see above). This edition is particularly valuable because of the introduction, the scholarly translation, the notes, and the illustrative diagrams.
- R. Hercher : *Aeneae Commentarius poliorceticus*. Berlin, 1870. *Editio maior*. An *editio minor*, later in the same year, corrected a number of errors that appeared in the former edition.
- A. Hug : *Aeneae Commentarius poliorceticus*. Leipzig, 1874.

INTRODUCTION

- R. Schöne: *Aeneae Tactici de Obsidione toleranda Commentarius*. Leipzig, 1911. This admirable work, based upon new collations of M, A, and B (see above) and prepared with the utmost accuracy and acumen, completely supplants all previous editions, and is the basis of the text as printed in this volume. An *index verborum* (which is in large part actually a concordance), composed with the assistance of Ferdinand Koester, adds materially to the value of the work.¹

TRANSLATIONS

In addition to the translations, listed above, by Casaubon, and by Köchly and Rüstow, the following should be mentioned:

- M. le Comte de Beausobre: *Commentaires sur la Défense des Places d'Aeneas le Tacticien, avec quelques Notes*, etc. Amsterdam, 1757, 2 vols.
- A. de Rochas d'Aiglun: *Traité de Fortification, d'Attaque et de Défense des Places par Philon de Bysance*. Paris, 1872. This is vol. vi of series iv of the *Mém. de la Soc. d'Émulation du Doubs*, 1870-1871 (Besançon, 1872), and contains a translation, with notes, of Aeneas, chapters 8, 16, 21, 22, 24-26, 31-35, 37, 39, 40, in whole or in part. Chapter 31 is taken from the translation of Beausobre. See R. Schöne, *Rhein. Mus.* lxxvii. (1912) 303.

¹ An edition announced by L. W. Hunter in 1913 is awaited with interest because of the promise to explain much of the corruption in M stichometrically, *i.e.*, by the falling out of an entire line at points where a group of similar letters appears either at the beginning or at the end of successive lines.

AENEAS TACTICUS

No translation of Aeneas has previously appeared in English.

CRITICAL WORKS

Beside the editions and translations enumerated above, the following monographs have contributed much to the understanding of Aeneas :

C. Behrendt : *De Aeneae Tactici Commentario poliorcetico Quaestiones selectae*. Diss., Königsberg, 1910. Behrendt's commentary as published covers only the first seven chapters. It is to be hoped that the remainder may soon appear.

Fr. Blass : *Literarisches Zentralblatt*, 1879, 1261 f.

Hermann Diels : Die Entdeckung des Alkohols. *Abhandl. der Königl. Preuss. Akad. der Wiss.*, Berlin, 1913, No. 3, 19.

Herbert Fischer : *Quaestiones Aeneanae*. Pars I. Giessen Diss., Dresden, 1911.

A. von Gutschmid : *Kleine Schriften*, vol. iv. 218-21 ; v. 191 ff. ; 214 ff.

Fr. Haase : *Neue Jahrbücher*, xiv. (1835) 93 ff. ; xvii. (1836) 206 ff.

F. C. Hertlein : *Symbolae criticae ad Aeneam Tacticum* Wertheim, 1859.

A. Hug : (1) *Prolegomena critica ad Aeneae Editionem*. Zürich, 1874. (2) *Aeneas von Stymphalos*, etc. Zürich, 1877. (3) *Neue Jahrbücher*, cxix. (1879) 241 ff., 639 ff.

L. W. Hunter : Aeneas Tacticus and Stichometry. *Classical Quarterly*, vii. (1913) 256-64.

A. Kirchhoff : *Hermes*, i. (1866) 448 ff. and in the preface to Hug's edition, vii ff

INTRODUCTION

- G. H. Koës : *Epistolae Parisienses*, ed. Bredow, 1812, 110 ff. (dealing with mss. ABC).
- A. C. Lange : (1) *De Aeneae Commentario poliorcetico*. Berlin, 1879. (2) *Neue Jahrbücher*, cxix. (1879) 461 ff. (3) *Animadversiones criticae in Aeneae Commentarium poliorceticum*. Cassel, 1883.
- Chr. Mahlstedt : *Über den Wortschatz des Aeneias Taktikus*. Kiel Diss., Jena, 1910.
- M. E. E. Meier : *Opuscula academica*, vol. ii., Halle 1863, 292-306.
- A. Mosbach : *De Aeneae Tactici Commentario poliorcetico*. Diss., Berlin, 1880.
- R. Pöhlmann : *Geschichte des antiken Kommunismus und Sozialismus*. Munich, 1901, vol. ii. 346-8 (= *Geschichte der sozialen Frage und des Sozialismus in der antiken Welt*. Munich, 1912, i. 421-24).
- J. J. Reiske : *Animadversiones ad Aeneam Tacticum*, published by R. Hercher in his *editio maior*, 128-33.
- J. Ries : *De Aeneae Tactici Commentario poliorcetico*. Diss., Halle, 1890.
- W. Rüstow und H. Köchly : *Geschichte des griechischen Kriegswesens*. Aarau, 1852, 196 ff.
- H. Sauppe : *Ausgewählte Schriften*. Berlin, 1896, 631-645.
- K. Schenkl : *Bursian's Jahresberichte*, xxxviii. (1884) 261-270.
- E. Schwartz : *Aineias*, in Pauly-Wissowa's *Realencyklopädie*, i. (1897) 1019-1021.
- T. Hudson Williams : The Authorship of the Greek military Manual attributed to 'Aeneas Tacticus.' *Amer. Journ. of Philol.* xxv. (1904) 390-405.

AENEAS TACTICUS

SYMBOLS

- A = *Codex Parisinus Graecus* 2435, s. xvi ; the more careful copy of M.
B = *Codex Parisinus Graecus* 2522, s. xv.
C = *Codex Parisinus Graecus* 2443, a. 1549.
M = *Codex Laurentianus Graecus* LV, 4, s. x.
J. Afr. = Excerpts from the *Κεστοί* of Sextus Julius Africanus, an author of the third century.

NOTE ON JULIUS AFRICANUS

As a necessary supplement to Aeneas we have included a text and translation of those portions of the *Κεστοί* of Sextus Julius Africanus which are clearly derived from the treatise before us. In so doing we have been compelled to emend the ms. tradition of Africanus in a much more drastic way than we should consider justified in a critical edition. Schöne, following Hercher's example, very properly left the ms. tradition as it stood, so as not to disguise any variants which might possibly throw light upon the present state of M. But to translate it is necessary to have a text which makes tolerable sense, which in this case necessitates liberal emendation. As in Aeneas, however, every real departure from the ms. tradition is noted in the apparatus. The references to mss. are taken from Schöne's edition and represent his selection of the critical materials gathered for a recension of Africanus by Fr Haase and K. K. Müller, with his own collation

INTRODUCTION

of the Barberini ms. in the Vatican (see the preface to his edition of Aeneas, ix). We have also made use of the text of the *Κεσσοί* in Thevenot's edition of the *Veteres Mathematici*, Paris, 1693, 275-316, with Boivin's notes, 339-60.

ΑΙΝΕΙΟΥ

ΠΕΡΙ ΤΟΥ

ΠΩΣ ΧΡΗ ΠΟΛΙΟΡΚΟΥΜΕΝΟΥΣ ΑΝΤΕΧΕΙΝ

Ὅσοις τῶν ἀνθρώπων ἐκ τῆς αὐτῶν² ὀρμωμένοις χώρας ὑπερόριοί τε ἀγῶνες καὶ κίνδυνοι συμβαίνουσιν, ἂν τι σφάλμα γένηται κατὰ γῆν ἢ κατὰ θάλασσαν, ὑπολείπεται τοῖς περιγυνομένοις αὐτῶν οἰκεία τε χώρα καὶ πόλις καὶ πατρίς, ὥστε οὐκ ἂν² ἄρδην πάντες ἀναιρεθείησαν· τοῖς δὲ ὑπὲρ τῶν μεγίστων μέλλουσι κινδυνεύειν, ἱερῶν καὶ πατρίδος καὶ γονέων καὶ τέκνων καὶ τῶν ἄλλων, οὐκ ἴσος οὐδὲ ὅμοιος ἀγὼν ἔστιν, ἀλλὰ σωθεῖσι μὲν καὶ καλῶς ἀμυναμένοις τοὺς πολεμίους φοβεροὺς τοῖς ἐναντίοις καὶ δυσεπιθέτους εἰς τὸν λοιπὸν χρόνον εἶναι, κακῶς δὲ προσενεχθεῖσι πρὸς τοὺς κινδύνους³ οὐδεμία ἐλπίς σωτηρίας ὑπάρξει. τοὺς οὖν ὑπὲρ τοσοῦτων καὶ τοιούτων μέλλοντας ἀγωνίζεσθαι οὐδεμιᾶς παρασκευῆς καὶ προθυμίας ἔλλιπεῖς εἶναι δεῖ, ἀλλὰ πολλῶν καὶ παντοίων ἔργων πρόνοιαν ἐκτέον, ὅπως διὰ γε αὐτούς³ μηδὲν φανῶσι⁴ σφαλέντες· ἂν δὲ ἄρα τι σύμπτωμα γένηται, ἀλλ' οἱ γε λοιποὶ τὰ ὑπάρχοντα εἰς ταυτό ποτε κατα-

AENEAS

ON THE DEFENCE OF FORTIFIED POSITIONS

WHEN men set out from their own country to encounter strife and perils in foreign lands and some disaster befalls them by land or sea, the survivors still have left their native soil, their city, and their fatherland, so that they are not all utterly destroyed. But for those who are to incur peril in defence of what they most prize, shrines and country, parents and children, and all else, the struggle is not the same nor even similar. For if they save themselves by a stout defence against the foe, their enemies will be intimidated and disinclined to attack them in the future, but if they make a poor showing in the face of danger, no hope of safety will be left. Those, therefore, who are to contend for all these precious stakes must fail in no preparation and no effort, but must take thought for many and varied activities, so that a failure may at least not seem due to their own fault. But if after all a reverse should befall them, yet at all events the survivors may

¹ Αίλιανού τακτικὸν ὑπόμνημα περὶ τοῦ κτλ. M. Cf. Introduction, 2 ff.

² Hertlein: ἀντῶν M. ³ Köchly and Rustow: ἀντοῦς M.

AENEAS TACTICUS

στήσαιεν ἄν,¹ καθάπερ τινές τῶν Ἑλλήνων εἰς τὸ ἔσχατον ἀφικόμενοι πάλιν ἀνέλαβον ἑαυτούς.

I.

Τὴν οὖν τῶν σωμαίων σύνταξιν σκεψαμένους πρὸς τὸ μέγεθος τῆς πόλεως καὶ τὴν διάθεσιν τοῦ ἄστεος καὶ τῶν φυλάκων τὰς καταστάσεις καὶ περιοδίας, καὶ ὅσα ἄλλα σώμασι κατὰ τὴν πόλιν χρηστέον, πρὸς ταῦτα τοὺς μερισμοὺς ποιητέον.
2 τοὺς μὲν γὰρ ἐκπορευομένους δεῖ συντετάχθαι πρὸς τοὺς ἐν τῇ πορείᾳ τόπους, ὡς χρὴ πορεύεσθαι παρά τε τὰ ἐπικίνδυνα χωρία καὶ ἐρυμνὰ καὶ στενόπορα καὶ πεδινὰ καὶ ὑπερδέξια καὶ ἐνεδρευτικά, καὶ τὰς τῶν ποταμῶν² διαβάσεις καὶ τὰς ἐκ τῶν
3 τοιούτων παρατάξεις· τὰ δὲ τειχήρη καὶ πολιτοφυλακήσοντα³ πρὸς μὲν τὰ τοιαῦτα οὐδὲν δεῖ συντετάχθαι, πρὸς δὲ τοὺς ἐν τῇ πόλει τόπους καὶ
4 τὸν παρόντα κίνδυνον. πρῶτον μὲν οὖν αὐτῶν⁴ ἀπονεῖμαι δεῖ τοὺς φρονιμωτάτους τε καὶ ἐμπείρους μάλιστα πολέμου, οἱ περὶ τοὺς ἄρχοντας

¹ Added by Hertlein.

² L. Dindorf: *πολεμίων* M.

³ Meier: *πολιτοφυλακήσοντα* M, Haase.

⁴ Casaubon: *αὐτὸν* M.

¹ Because this was the side unprotected by their shields. Approaches to city gates in particular were frequently so constructed as to compel assailants to expose their right sides to missiles hurled by the defenders, for example, the main entrances at Tiryns and at Mycenae. Such also was undoubtedly the character of the famous "Scaean (*i.e.* left-hand) Gate" of Troy.

² See below § 6, and especially ch. 10.

³ These men constitute a staff of military advisers, the remote prototype of the modern General Staff. Köchly and

AENEAS THE TACTICIAN, I. 1-4

some time restore their affairs to their former condition, like certain Greek peoples who, after being reduced to extremes, have re-established themselves.

I.

Now the disposition of the troops is to be made with reference to the size of the state and the topography of the town, its sentries and patrols, and any other service for which troops are required in the city,—in view of all this the assignments are to be made. So men who are going to fight outside the walls must be drawn up in a manner suitable to the country along their line of march, according as they are to march past dangerous or fortified places, through narrow passes or across plains, past higher ground upon the right¹ and points exposed to ambush, with reference also to the river-crossings and the formation of a line of battle under such conditions. But the forces which are to defend the walls and keep watch over the citizens² need not be so arranged, but rather with reference to the positions within the city and to the immediate danger. First, then, it is necessary to select the most prudent citizens and those most experienced in war for attendance upon the civil authorities.³

Rüstow seem to be in error in identifying these men with the body of troops mentioned in 16. 7 ; 17. 6 ; 26. 10 ; 38. 2, for these latter are selected for some particular purpose, or else are the same as the reserves mentioned in §§ 6 and 7 below. In some of the more highly organized Greek states military control was vested in a permanent board of Generals, ten in number (as at Athens), elected directly by the citizens. Livy xxiv. 28 gives an example of how this precept of Aeneas was put into practice during the confusion at Syracuse in 214 B.C.

AENEAS TACTICUS

5 ἔσονται· ἔπειτα λοιπὸν ἀπολέγειν σώματα τὰ¹
 δυνασόμενα μάλιστα πονεῖν, καὶ μερίσαντα²
 λοχίσαι, ἵνα εἰς τε τὰς ἐξόδους καὶ τὰς κατὰ πόλιν
 περιодίας καὶ τὰς τῶν πονουμένων βοηθείας ἢ
 εἰς τινα ἄλλην ὁμότροπον ταύταις λειτουργίαν
 6 ὑπάρχωσιν οὗτοι προτεταγμένοι τε καὶ δυνατοὶ
 ὄντες ὑπηρετεῖν. εἶναι δὲ αὐτοὺς εὖνους τε καὶ
 τοῖς καθεστηκόσι πράγμασιν ἀρεσκομένους· μέγα
 γὰρ πρὸς τὰς τῶν ἄλλων ἐπιβουλάς τοιοῦτο³
 ἀθρόον ὑπάρχον ἀντ' ἀκροπόλεως· φόβος γὰρ ἂν
 7 εἴη τοῖς ἐναντία θέλουσιν ἐν τῇ πόλει. ἡγεμῶν
 δὲ καὶ⁴ ἐπιμελητῆς αὐτῶν ἔστω τά τε ἄλλα
 φρόνιμος καὶ εὖρωστος, καὶ ὧ ἂν πλεῖστοι κίνδυνοι
 8 εἴεν μεταβολῆς γενομένης. τῶν δὲ λοιπῶν τοὺς
 ῥωμαλεωτάτους ἡλικία καὶ νεότητι ἐκλέξαντα
 ἐπὶ τὰς φυλακὰς καθιστάναι καὶ τὰ τείχη, τὸ δὲ
 περιὸν πλῆθος μερίσαντα πρὸς τὸ μῆκος τῶν
 νυκτῶν καὶ τῶν φυλάκων τὸ πλῆθος κατανεῖμαι,
 9 τῶν δὲ ὄχλων τοὺς μὲν εἰς τὴν ἀγοράν, τοὺς δὲ εἰς
 τὸ θέατρον, τοὺς δὲ ἄλλους εἰς τὰς οὔσας⁵ ἐν τῇ
 πόλει εὐρυχωρίας, ἵνα μηδὲν ἔρημον ἢ εἰς δύναμιν
 τῆς πόλεως.

II.

* Ἀριστον⁶ δὲ τὰς ἀχρεῖους οὔσας εὐρυχωρίας
 ἐν τῇ πόλει, ἵνα μὴ σωμαίων εἰς αὐτὰς δέη,
 τυφλοῦν ταφρεύοντα καὶ ὡς μάλιστα ἀβάτους

¹ Added by Köchly and Rüstow.

² Casaubon: μερίσαντα M.

³ Hertlein (τοιοῦτον): τοῦτο M. ⁴ Hertlein: καὶ ὁ M.

⁵ οὔσιασ M (i deleted? οὔσας A, οὔσας B).

⁶ Casp. Orelli: εὐχρηστον? R. Schöne: ἀχρηστον M (re-
 tained by Casaubon, defended by Fischer).

AENEAS THE TACTICIAN, I. 4 - II. 1

Next one must pick out men capable of the greatest physical exertion and divide them into companies, that there may be ready for sallies, for patrolling the city, for the relief of those hard pressed, or for any other similar service, these who are picked men and able to give assistance.¹ They must be both loyal and satisfied with the existing order, since it is a great thing to have such a group acting like a fortress against the revolutionary designs of the other party, for it would be a terror to the opposition inside the city.² And let the man who is to lead and have charge of them be not merely prudent and vigorous, but also one who would run the greatest risks from a change of government. From the rest the strongest, in the prime of manhood, should be chosen for the watches and the walls, while the remainder should be divided and apportioned according to the length of the nights and the number of the watches. Of the common soldiers some should be stationed in the market-place, some in the theatre, and the rest in the open places in the city, so that as far as the city's power permits no part may be unguarded.

II.

And that there may be no need of troops to guard them, it is best to block up the useless open places in the city by digging ditches³ and by

¹ Compare the modern equivalent in the shape of *Arditi*, *Stoss-Truppen*, and Battalions of Death.

² See ch. 10 for a detailed treatment of this topic.

³ That is, across the entrances to them.

AENEAS TACTICUS

ποιούντα τοῖς νεωτερίζειν βουλομένοις καὶ προ-
 2 καταλαμβάνειν αὐτάς. Λακεδαιμόνιοι δὴ¹ Θη-
 βαίων ἐμβαλόντων ἔκ τε τῶν ἐγγυτάτω οἰκιῶν
 διαλύντες καὶ ἔκ τῶν αἵμασιῶν καὶ τειχιῶν²
 ἄλλοι κατ' ἄλλους τόπους φορμούς γῆς καὶ λίθων
 πληροῦντες, φασὶν δὲ καὶ τοῖς ἔκ τῶν ἱερῶν χαλκοῖς
 τρίποσιν, ὄντων πολλῶν καὶ μεγάλων, χρησάμενοι
 καὶ τούτοις προαποπληρώσαντες τὰς τε εἰσβολὰς
 καὶ τὰς διόδους καὶ τὰ εὐρύχωρα τοῦ πόλιςματος
 ἐκώλυσαν τοὺς εἰσβάλλειν ἐπιχειροῦντας εἰς αὐτὸ
 τὸ πόλισμα.

4 Πλαταιεῖς δὲ ἐπεὶ ἦσθοντο νυκτὸς ἐν τῇ πόλει
 Θηβαίους ὄντας, κατανοήσαντες οὐ πολλοὺς αὐτοὺς
 ὄντας οὐδὲ ἔργων τῶν προσηκόντων ἀπτομένους,
 οἰομένους γε μέντοι κατέχειν τὴν πόλιν, ἐνόμισαν
 ἐπιθέμενοι ῥαδίως κρατήσειν. τεχνάζουσιν οὖν
 4 εὐθέως τοιόνδε. τῶν ἀρχόντων οἱ μὲν ὁμολογίας
 ἐποιοῦντο τοῖς Θηβαίοις ἐν τῇ ἀγορᾷ, οἱ δὲ παρήγ-
 γελλον κρύφα τοῖς ἄλλοις πολίταις σποράδην μὲν
 ἔκ τῶν οἰκιῶν μὴ ἐξιέναι, καθ' ἓνα δὲ καὶ δύο
 τοὺς κοινούς τοίχους διορύττοντας λαθραίως παρ'
 5 ἀλλήλους ἀθροίζεσθαι. ἐτοιμασθέντος δὲ πλήθους
 ἀξιωμαχοῦ τὰς³ μὲν διόδους καὶ τὰς ρύμας
 ἐτύφλωσαν ἀμάξαις ἀνευ ὑποζυγίων, ἀπὸ⁴ δὲ

¹ Sauppe : δὲ M.

² Meineke : τειχῶν M.

³ A corrector in C : τοὺς M.

⁴ Hertlein : ὑπὸ M.

AENEAS THE TACTICIAN, II. 1-5

making them as inaccessible as possible to any who might wish to start a revolt and begin by taking possession of them. So, when the Thebans had broken in, the Lacedaemonians, some here and others there, filled baskets with earth and stones from the nearest houses, which they tore down, and from fences and walls, making use also, it is said, of the many massive bronze tripods from the temples, and with these they managed, in advance of the Thebans, to block up the entrances and passages and open places and kept them out when they tried to break into the city proper.¹

On another occasion, when the Plataeans became aware during the night that the Thebans were in the city, they perceived that there were not many of them and that they were taking none of the proper precautions because they fancied that they were in possession of the town.² The Plataeans concluded, therefore, that they could easily defeat them by an attack, and so promptly devised the following scheme. Some of the authorities engaged the Thebans in the market-place in a discussion of terms, while others were secretly passing the word around to the rest of the citizens not to go out of their houses singly, but one or two at a time to break through the party-walls and assemble stealthily in one another's houses. When a sufficient fighting force was ready, they blocked up the streets and alleys, using wagons without the draft-

¹ This occurred in the summer of 362 B.C., shortly before the battle of Mantinea, in which Epaminondas lost his life.

² This was the famous night attack upon Plataea in the spring of 431 B.C. which opened the Peloponnesian war. It is described in detail by Thucydides ii. 2 ff., whose account is closely followed by Aeneas.

AENEAS TACTICUS

σημείου ἀθροισθέντες ἐφέροντο ἐπὶ τοὺς Θηβαίους.
 6 ἄμα δὲ τούτοις τὰ γύναια καὶ οἱ οἰκέται ἦσαν ἐπὶ τοῖς κεράμοις, ὥστε βουλομένων τῶν Θηβαίων πράσσειν καὶ ἀμύνεσθαι ἐν σκότει, οὐκ ἐλάττω ὑπὸ τῶν ἀμαξῶν βλάβην ἢ ὑπὸ τῶν προσκειμένων αὐτοῖς ἀνθρώπων γενέσθαι. οἱ μὲν γὰρ ἔφευγον¹ ἄπειροι ὄντες ἢ χρὴ σωθῆναι διὰ τὰς φράξεις τῶν ἀμαξῶν, οἱ δὲ ἐμπείρως διώκοντες ταχὺ πολλοὺς ἔφθειραν.

7 Ἐξοιστέον δὲ καὶ τὰ ὑπεναντία τούτοις, ὡς μιᾶς μὲν οὔσης εὐρυχωρίας κίνδυνον εἶναι τοῖς ἐν τῇ πόλει, ἂν προκαταλαμβάνωσιν οἱ ἐπιβουλεύοντες· κοινοῦ γὰρ καὶ ἐνὸς ὄντος τόπου τοιούτου τῶν φθασάντων ἂν εἴη τὸ ἔργον. δύο δὲ ἢ τριῶν ὄντων
 8 τοιῶνδε τόπων, τάδε ἂν εἴη τὰ ἀγαθὰ· εἰ μὲν ἓνα ἢ δύο καταλαμβάνοιεν τόπους, τὸν λοιπὸν ἂν τοῖς ἐναντίοις ὑπάρχειν· εἰ δὲ πάντας, χωρισθέντες ἂν καὶ μερισθέντες ἀσθενεστέρως διακέοιντο πρὸς τοὺς ὑπεναντίους ἀθρούς ὄντας, εἰ μὴ ἐκάστῳ μέρει ὑπερέχοιεν τῶν ἐν τῇ πόλει. ὡς δὲ αὐτως καὶ κατὰ τῶν ἄλλων πάντων θελημάτων χρὴ τὰ ἐνόητα ὑπεναντία τοῖς προγεγραμμένοις ὑπονοεῖν, ἵνα μὴ ἀπερισκέπτως τι ἕτερον αἰρήῃ.²

III. [Ἄλλη πολιτοφυλάκων σύνταξις]

Ἐκ προσφάτου δὲ ἐγγιγνομένου φόβου ἀσυντάκτῳ πόλει, τάχιστα ἂν τις εἰς σύνταξιν καὶ φυλακὴν τῆς πόλεως τοὺς πολίτας καταστήσῃ,³

¹ ἔφυγον Kirchhoff. from Thucydides ii. 4. The better reading ἔφευγον was restored in Thucydides by Hude.

² R. Schöne: αἰρήσαι M.

³ Köchly and Rüstow: καταστήσοι M.

AENEAS THE TACTICIAN, II. 5 - III. 1

animals, and rushing together at a given signal, fell upon the Thebans. At the same time the women-folk and the house-slaves were on the tile-roofs.¹ The result was that when the Thebans wished to act and to defend themselves in the darkness they suffered no less harm from the wagons than from their assailants, since they fled without knowing which way to turn for safety because of the barricades of wagons, while their pursuers, being acquainted with the ground, soon killed many of them.

Yet it is necessary to set forth also the reasons which make against this practice, such as the great danger to the besieged if there is only one open place and the conspirators are the first to seize it. For when there is only one such common spot, the advantage would lie with those who first take it. But if there are two or three such places, there would be these advantages: If the conspirators should seize one or two there would still be one left for their opponents; and if they should seize them all, by separation and division they would be weaker in the face of their united opponents, unless indeed each division were numerically superior to the defenders of the city. In the same way in all other decisions one should consider the inherent objections to the prescribed rules, that one may not inadvisedly adopt another course.

III. [*Another Organization of City Guards*]

When sudden fear falls upon a city without military organization, one could most speedily organize the citizens for its defence by allotting

¹ From this vantage-point they joined in the outcry and hurled tiles upon the enemy in the streets below.

AENEAS TACTICUS

εἰ ἐκάστη φυλῇ μέρος τι τοῦ τείχους κλήρω ἀποδείξειεν, ἐφ' ᾧ ἔλθοῦσαι εὐθὺς αἱ φυλαὶ φυλάξουσιν. κατὰ πολυπλήθειαν¹ δὲ φυλῆς ἐκάστης
 2 τὸ μέγεθος τοῦ τείχους φυλαττόντων. ἔπειτα οὕτως ἀφ'² ἐκάστης φυλῆς τοὺς δυναμένους τοῖς σώμασι πονέσαι ἀπολέγειν εἰς τε τὴν ἀγορὰν καὶ τὰς περιодίας, καὶ εἴ τι ἄλλο δεῖ χρῆσθαι τοῖς
 3 τοιούτοις ἀνθρώποις.³ ὁμοτρόπως δὲ καὶ φρουρίου ὑπὸ συμμάχων φρουρουμένου μέρος τι τοῦ τείχους τῶν συμμάχων ἐκάστοις ἀποδιδόσθω φυλάττειν. ἐὰν δὲ πολῖται ἐν ὑποψία πρὸς ἀλλήλους⁴ ᾧσιν, κατὰ ἀνάβασιν ἐκάστην τοῦ τείχους δεῖ ἐπιστήσασιν ἀνδρας πιστοὺς, οἳ κωλυταὶ ἔσονται, ἂν τις ἐπι-
 4 χειρῇ ἄλλος ἀναβαίνειν. ἐν εἰρήνῃ δὲ καὶ ᾧδε χρῆ συντετάχθαι τοὺς πολίτας. πρῶτον μὲν ρύμης ἐκάστης ἀποδείξει ρυμάρχην ἀνδρα τὸν ἐπιεικέστατον τε καὶ φρονιμώτατον, πρὸς ὃν, ἐὰν τι ἀπροσδοκῆτως νυκτὸς γένηται, συναθροισθήσονται.
 5 χρῆ δὲ τὰς ἐγγυτάτας⁵ ρύμας τῆς ἀγορᾶς εἰς τὴν ἀγορὰν ἄγειν τοὺς ρυμάρχας, τοῦ δὲ θεάτρου τὰς ἐγγυτάτω ρύμας εἰς τὸ θέατρον, εἰς τε τὰς ἄλλας ἕκαστον ἐγγύτατα εὐρυχωρίας ἀθροίζεσθαι τοὺς ρυμάρχας μετὰ τῶν ἐξενεγκαμένων παρ' αὐτοῦς
 6 τὰ ὄπλα· οὕτω γὰρ ἂν τάχιστα ἔς τε τοὺς προσήκοντας ἕκαστοι τόπους ἀφίκοντο καὶ ἐγγυτάτω τῶν σφετέρων οἴκων εἶεν, διαπέμποιέν τε ἂν οἰκονομοῦντες πρὸς τοὺς κατ' οἶκον, τέκνα καὶ γυναῖκας, οὐ πρόσω αὐτῶν διατελοῦντες. τῶν τε ἀρχόντων δεῖ προκεκληρῶσθαι εἰς ὃν ἕκαστοι

¹ Hercher: καταπολυπληθειαν M. ² Reiske: ἐφ' M.

³ Casaubon: ἀνθρωπος M. ⁴ Casaubon: ἄλλοισ M.

⁵ ἐγγύτατα R. Schöne: ἐγγυτάτω Hercher.

AENEAS THE TACTICIAN, III. 1 - 6

to each ward a section of the wall to which it is to hurry and mount guard, letting the number of the inhabitants of the ward determine the extent of that section of the wall to whose defence it is appointed. The next step is to assign the able-bodied men from each ward to duty at the market-place, upon patrols, and wherever else such men may be needed. Similarly when a stronghold is occupied by allies, let a section of the wall be given to each contingent of the allies to defend. Should the citizens, however, suspect one another, trustworthy men should be stationed at the several places for ascending the wall, who, if anyone else attempts to mount, will prevent him from doing so. In peace, also, the citizens ought to be organized in the following manner. First of all one should appoint as captain of each precinct the most capable and prudent man, to whom the citizens are to rally if anything unexpected occurs at night. The precinct captains should muster at the market-place the men of those precincts nearest the market-place, at the theatre the men of those precincts nearest the theatre, and so for the other open places the precinct captains with the armed men who have reported to them should gather, each in the one that lies nearest to him. For this is the quickest way by which each group would both reach their stations and be near their own homes, and so, as heads of families, could communicate with their households, that is, with their children and wives, because stationed not far from them. And it should be determined beforehand by lot to which

AENEAS THE TACTICIAN, III. 6 - IV. 5

quarter each of the authorities should go and send detachments of troops to the battlements. Moreover, there will be leaders to look after everything else, provided that they thus assume immediate command.

IV. [*On pre-arranged Signals*]

As quickly as possible the besieged must be provided with signals, so that they will not fail to recognize those who approach them. For this is the sort of thing that has happened: Chalcis on the Euripus¹ was captured by a fugitive operating from Eretria, aided by one of the inhabitants of the town who practised a stratagem of the following description. To the most deserted part of the city, where the gate was regularly closed, he kept bringing a firepot, and by keeping the fire going day and night he secretly one night burned through the bar of the gate and admitted soldiers at that point.² When about two thousand men had gathered in the market-place, the alarm was hastily sounded and many of the Chalcidians were killed because they were not recognized, for in their panic they aligned themselves with their enemies as though they were their friends, each thinking that he was late in coming up. In this way, then, most of them perished by ones and twos, and the city had been in the hands of the enemy for some time before the citizens knew what was happening. It is necessary,

¹ In this difficult passage we follow Wunsch and Behrendt (see the latter's dissertation, pp. 78 ff.). The word translated "firepot" occurs nowhere else in Greek, but there are close parallels and the general sense of the passage is clear.

AENEAS TACTICUS

- καὶ ἐγγὺς ὄντων τῶν πολεμίων, πρῶτον μὲν τὰ ἀποστελλόμενα ἐκ τῆς πόλεως κατὰ γῆν ἢ κατὰ θάλατταν ἐπὶ τινα πρᾶξιν πρὸς τοὺς ὑπομένοντας μετὰ συσσήμων ἀποστέλλεσθαι καὶ ἡμερινῶν καὶ νυκτερινῶν, ἵνα μὴ ἀγνοῶσι πολεμίων αὐτοῖς
- 6 ἐπιφαινομένων, εἰ¹ φίλιοι ἢ πολέμοι εἰσιν· ἐπὶ δὲ πρᾶξιν πορευθέντων καὶ πέμπειν τινὰς γνωσομένους, ἵνα καὶ τὰ τοιαῦτα ὡς ἐκ πλείστου τῶν ἀπόντων οἱ ὑπομένοντες εἰδῶσιν.² μέγα γὰρ ἂν φέροι πρὸς τὸ μέλλον ἐκ πλείονος παρασκευάζεσθαι.
- 7 τοῖς δὲ μὴ οὕτω πράττουσιν ἃ συμβέβηκεν ἐμφανισθήσεται τινῶν³ ἤδη γενομένων, ἃ⁴ ἐπὶ παραδείγματος καὶ μαρτυρίου καθαροῦ παραλέγεται.
- 8 Πεισιστράτῳ γὰρ Ἀθηναίων στρατηγούντι ἐξηγγέλη ὅτι οἱ ἐκ Μεγάρων οἱ ἐπιχειροῖεν ἀφικόμενοι πλοίοις ἐπιθέσθαι νυκτὸς ταῖς τῶν Ἀθηναίων γυναιξὶν θεσμοφόρια ἀγούσαις ἐν Ἐλευσίνι· ὁ δὲ
- 9 Πεισίστρατος ἀκούσας προενήδρευσε.⁵ ἐπεὶ δὲ οἱ ἐκ τῶν Μεγάρων ὡς λεληθότες ἀπέβησαν καὶ ἀπὸ τῆς θαλάττης ἐγένοντο, ἐξαναστὰς ὁ Πεισίστρατος τῶν ἐνεδρευθέντων⁶ τε ἀνδρῶν ἐκράτησεν καὶ διέφθειρεν τοὺς πλείστους, καὶ τῶν πλοίων
- 10 οἷς ἀφίκοντο ἐγκρατῆς ἐγένετο. ἔπειτα παραχρῆμα τοῖς ἑαυτοῦ στρατιώταις πληρώσας τὰ πλοῖα ἔλαβε τῶν γυναικῶν τὰς ἐπιτηδειοτάτας

¹ Added by Casaubon.

² Reiske: ἴδωσιν M.

³ Wunsch: τῶν M.

⁴ Wunsch (cf. Goodwin, *Moods and Tenses*, § 258; Kühmergerth, i. 220, n. 2; perhaps the least unsatisfactory restoration of a serious corruption): ἵνα M: R. Schöne indicates a lacuna after γενομένων.

⁵ Casaubon: προσενέδρευσε M.

⁶ Meineke: ἐνεδρευόντων M.

AENEAS THE TACTICIAN, iv. 5 - 10

then, in time of war, especially when the enemy is near at hand, first, that the forces which are being sent from the city on some enterprise by land or sea should be furnished with signals for use both by day and by night to those who remain, in order that the latter, if the enemy appear in the meantime, may not be unable to tell friend from foe. And, secondly, after their departure upon the enterprise, persons who will recognize the signals should be sent to watch, so that the men at home may get information of this kind while those returning are still a great way off. For it would be a great advantage to make preparations long beforehand for what is impending. What has befallen those who did not take such precautions will be clear from some actual incidents which may be told in passing as illustration and definite evidence. Word was brought to Peisistratus, when he was general at Athens,¹ that the Megarians would come in ships, and attempt a night attack upon the Athenian women while they were celebrating at Eleusis the festival of Demeter. On hearing this Peisistratus set an ambush ahead of them, and when the Megarians disembarked, in secrecy as they supposed, and were some distance from the sea, he rose up and overcame those who had been trapped, killed most of them, and captured the ships in which they had come. Then after quickly filling the ships with his own soldiers, he took from among the women those best fitted to

¹ This incident occurred during the long series of wars with Megara in which Salamis was first lost by Athens and then recovered for her by Solon, and Peisistratus captured Nisaea, the haven of Megara. As Peisistratus at the time of the adventure here described was not yet tyrant, it must have occurred prior to 561-60 B.C.

AENEAS TACTICUS

- συμπλεῦσαι, καὶ κατήγετο εἰς τὰ Μέγαρα ὄψε
11 ἀπωτέρω τῆς πόλεως. κατιδόντες οὖν τὰ πλοῖα
προσπλέοντα ἀπήντων πολλοὶ τῶν Μεγαρέων, αἵ
τε συναρχαίαι καὶ οἱ ἄλλοι, θεώμενοι ὡς εἰκὸς
αἰχμαλώτους ἀγομένας ὡς πλείστας. . . ¹ καὶ μετ'
ἐγχειριδίων ἀποβάντες τοὺς μὲν καταβαλεῖν, ὅσους
δὲ ἂν δύναιτο τῶν ἐπιφανεστάτων συναρπάζειν εἰς
12 τὰ πλοῖα. καὶ οὕτως ἐπράχθη. δῆλον οὖν ὅτι
μετὰ συσσήμων καὶ μὴ ἀγνοουμένων πρὸς ἀλλήλους,
τὰς ἀθροίσεις καὶ τὰς πέμψεις δεῖ ποιεῖσθαι.

V. [Περὶ πυλωρῶν]

- *Ἐπειτα πυλωροὺς καθεστάναι μὴ τοὺς τυχόντας
ἀλλὰ φρονίμους καὶ ἀγχίνους, καὶ δὴ ὑπονοεῖν
δυναμένους² αἰεὶ τι τῶν εἰσκομιζομένων, ἔτι δὲ
καὶ εὐπόρους καὶ οἷς ἐνέχυρα ἐν τῇ πόλει ὑπάρχει,
τέκνα καὶ γυναῖκα λέγω, ἀλλὰ μὴ οἷτινες δι'
ἔνδειαν ἢ συναλλαγμάτων ἀνάγκην ἢ δι' ἄλλην
τινὰ ἀπορίαν πεισθεῖεν ὑπὸ τινων ἢ αὐτοὶ παρα-
2 κελεύσαιεν ἂν τινας ἐπὶ νεωτερισμῶ. Λεύκων δὲ
ὁ Βοσπόρου τύραννος καὶ τῶν φρουρῶν τοὺς
χρεωφειλέτας διὰ κυβείαν ἢ δι' ἄλλας³ ἀκολασίας
ἀπομίσθους ἐποίει.

¹ Casaubon indicated the lacuna.

² Meineke: μὴ ὑπονοεῖν μηδυναμένους M.

³ χρεωφειλέτας . . . κυβείαν . . . δι' ἄλλου M.

make the voyage, and late in the day landed at Megara at some distance from the city. Now many of the Megarians, officials and others, when they caught sight of the ships sailing into the harbour, went out to meet them, wishing, no doubt, to see as many women as possible brought in as captives. [Then the Athenians were ordered to attack the enemy], and disembarking with daggers in their hands to strike down some of the Megarians, but to bring back to the ships as many as possible of the most prominent men; and this they did. From what has been said, then, it is clear that for the conduct of musters and expeditions it is necessary to have prearranged signals, and those of a kind that cannot be misunderstood.

V. [*On Gate-keepers*]

In the next place, no chance persons should be appointed keepers of the gates, but only discreet and sagacious men always capable of suspecting anything brought into the city; and besides they should be well-to-do and men who have something at stake in the city, that is to say, wife and children; but not men who, because of poverty, or the pressure of some agreement, or from other stress of circumstances, might either be persuaded by anyone or of themselves incite others to revolt. Leuco, the tyrant of Bosphorus,¹ used to discharge even those among his guards who were in debt as a result of dice-playing or other excesses.

¹ This was the region about the Cimmerian Bosphorus (the entrance to the Sea of Azov) over which Leuco, an able and honourable man, ruled from 393 to 353 B.C.

AENEAS TACTICUS

VI. [Ἡμεροσκοπία]

Χρῆ δὲ καὶ ἡμεροσκοποῦς πρὸ τῆς πόλεως
καθιστάναί ἐπὶ τόπῳ ὑψηλῷ καὶ ὡς ἐκ πλείστου
φαινομένῳ· ἡμεροσκοπεῖν δὲ ἐφ' ἐκάστῳ χωρίῳ
τρεῖς τοῦλάχιστον, μὴ τοὺς τυχόντας, ἀλλ' ἐμπεί-
ρους πολέμου, ὅπως μὴ δι' ἄγνοιαν δοξάζων¹ τι
ὁ σκοπὸς σημάνη ἢ διαγγείλη εἰς τὴν πόλιν καὶ
2 ματαίως ὀχλῆ τοῖς ἀνθρώποις. πάσχοισι δὲ ταῦτα
οἱ ἄπειροι τάξεων καὶ πολέμου, ἀγνοοῦντες τὰς
τῶν πολεμίων ἐργασίας καὶ πράξεις, εἴτε ἐκ
παρασκευῆς πράσσεται, εἴτε καὶ παρὰ ταῦτομάτου.
3 ὁ δὲ ἔμπειρος, γνοὺς τὴν τῶν πολεμίων παρασκευὴν
καὶ πλῆθος καὶ πορείας καὶ τὴν ἄλλην κίνησιν
τοῦ στρατεύματος, οὕτω τὴν ἀλήθειαν ἐμφανιεῖ.
4 Ἐὰν δὲ μὴ ὑπάρχωσιν τοιοῦδε τόποι, ὥστε καὶ
εἰς τὴν πόλιν ἀπ' αὐτῶν² φαίνεσθαι τὰ σημεῖα,
ἄλλους ἐπ' ἄλλοις τόποις διαδεκτῆρας εἶναι τῶν
ἄειρομένων σημείων, οἱ σηματοῦσιν³ εἰς τὴν
5 πόλιν. εἶναι δὲ τοὺς ἡμεροσκοποῦς καὶ ποδώκεις,
οἱ ὅσα μὴ οἶά τε διὰ⁴ τῶν σημείων δηλοῦν, ἀλλ'
αὐτῶν τινα δέη ἐξ ἀνάγκης ἀγγέλλειν, δύνωνται⁵
ταχὺ ἀφικνεῖσθαι, καὶ⁶ ὡς ἐκ πλείστου ἀγγέλλωσιν.
6 Ἄριστον δὲ ἵππασίμων ὄντων τόπων καὶ ὑπαρ-
χόντων ἵππων⁷ ἵππείας συνείρειν,⁸ ἵνα διὰ τῶνδε
θᾶσσον ἀγγέλληται. πέμπειν δὲ ἐκ τῆς πόλεως
τοὺς ἡμεροσκοποῦς ὄρθρου ἢ ἔτι νυκτός, ἵνα τοῖς
τῶν πολεμίων σκοποῖς μὴ κατάδηλοι ᾖσιν ἡμέρας
7 πορευόμενοι ἐπὶ τὰ⁹ ἡμεροσκοπεῖα.¹⁰ σύνθημα

¹ Casaubon: δοξάζον M.

² ἀπαντῶν M.

³ Köchly and Rustow: σημαίνουσιν M.

⁴ Added in B (C).

⁵ δυνήσονται R. Schöne.

AENEAS THE TACTICIAN, vi. 1-7

VI. [*Scouting by Day*]

Day scouts also must be stationed before the city on a high place visible for as long a distance as possible. At least three scouts should be at each place, not chosen at random, but men skilled in warfare, so that a single scout may not ignorantly form an opinion and signal or announce it to the city and trouble the inhabitants to no purpose. Persons inexperienced in military formations are likely to do this through not knowing whether the enemy's acts and deeds are intentional or only accidental, but the experienced man, understanding the preparations of the enemy, his numbers, line of march, and other movements, will report the truth.

If there are no such places from which the signals may be given to the city, there must be relays of persons at different points to receive the signals as they are raised and pass them on to the city. The day scouts must also be swift of foot so that they can come quickly and report, even from great distances, matters which cannot be signalled but must by all means be reported by one of them.

If there are at hand horses and places fit for the use of horses, it is best to employ relays of horsemen so that messages may be conveyed more quickly. The day scouts must be sent from the city at dawn or while it is still night, lest they be seen by the scouts of the enemy as they go by daylight to their posts.

⁶ κἀν Hercher.

⁷ C: ἰππέων M.

⁸ A correction in B (C): συνιμίρειν M: συνεργεῖν Hercher: συναίρειν Meineke: συνημερεύειν Bursian: συναγείρειν Oldfather.

⁹ B in margin (C): ἔπειτα M.

¹⁰ Casaubon: ἡμεροσκοπία M.

AENEAS TACTICUS

δὲ μὴ¹ ἔχειν αὐτοὺς ἐν καὶ τὸ αὐτὸ . . .,² ὅπως μῆτε ἐκόντες μῆτε ἄκοντες, ἐὰν συλληφθῶσιν ὑπὸ τῶν πολεμίων, εἰπεῖν ἔχωσι τὸ τῶν ἐν τῇ πόλει σύνθημα. παραγγέλλεσθαι δὲ τοῖς ἡμεροσκόποις αἶρειν τὰ σύσσημα³ ἐνίοτε, καθάπερ οἱ πυρσευταὶ τοὺς πυρσούς.

VII.

Ὅταν δὲ ἡ χώρα ἐγκάρπως⁴ διακέηται⁵ μὴ πόρρω ὄντων πολεμίων, εἰκὸς πολλοὺς τῶν ἐν τῇ πόλει περὶ τοὺς ἐγγὺς χώρους διατελεῖν, γλιχο-
² μένους τοῦ καρποῦ. τούτους δ' οὖν εἰς τὴν πόλιν ἀθροίζειν ὧδε χρή. πρῶτον μὲν τοῖς ἔξω ἅμα ἡλίω δύνοντι σημαίνειν ἀπιέναι εἰς τὴν πόλιν· ἐὰν δὲ καὶ ἐπὶ πλεόν τῆς χώρας ἐσκεδασμένοι ὦσιν, ὑπὸ διαδεκτῆρων σημαίνεσθαι, ὅπως πάντες
³ ἢ οἱ πλείστοι παραγίγνωνται εἰς πόλιν. ἐπειδὴν δὲ τούτοις σημανθῆ ἀπιέναι, οὕτως τοῖς ἐν τῇ πόλει δειπνοποιεῖσθαι· τὸ δὲ τρίτον σημαίνειν εἰς
⁴ φυλακὴν ἰέναι καὶ καθιστάναι. ὡς δὲ δεῖ τοῦτο⁶ γίνεσθαι καὶ ὡς αἶρειν τοὺς φρυκτούς, ἐν τῇ Παρασκευαστικῇ βίβλῳ πλείονως εἴρηται. ὅθεν δεῖ τὴν μάθησιν λαμβάνειν, ἵνα μὴ δις⁷ περὶ τῶν αὐτῶν γράφειν συμβῆ.

¹ Added by Kochly and Rustow.

² A lacuna of five letters is indicated here in M.

³ σύσσημα M.

⁴ Reiske: ἐγκαρπος M.

⁵ W. Dindorf: διάκειται M.

⁶ Casaubon: τούτους M.

⁷ Casaubon: μηδεῖς M.

¹ For one of the recommendations of Aeneas upon this point see the long quotation from Polybius given as Frag. 3 at the end of this text. This, the earliest form of telegraphy,

They must not have the same watchword . . . so that if they are captured by the enemy they may be able neither willingly nor unwillingly to reveal the watchword of those in the city. The day scouts should be told to raise their signals now and then just as the night scouts raise their torches.

VII.

Whenever it is harvest time in the country and the enemy is not far away, many of those in the city are likely to tarry in near-by places, eager to save the crops. These persons must be gathered into the city thus. First, they must be signalled to come into the city by sunset, but if they are scattered over too much territory signals must be given by relays, so that all, or most of them, may reach the city. When the signal is given for them to leave the fields, one must also be given to those in the city to prepare the evening meal. Third, the guard must be signalled to go and take their posts. How this is to be done and how they are to raise the signal fires¹ is treated more fully in the book on *Military Preparations*. One must get his information from that, so that I may not have to write twice about the same matters.

seems to have been employed first by the Persians in 490 B.C. (Ephorus, *Frag.* 107 in *Fragm. Hist. Graec.*), then by the Greeks at Artemisium in 480 B.C. (Herodotus vii. 182), and became a common thing in the Peloponnesian war. Readers will be reminded of the brilliant description of such a beacon signal given by Aeschylus in the *Agam.* vv. 281-316. Compare in general A. C. Merriam, "Telegraphing among the Ancients"; *Papers of the Archaeolog. Inst. of America*, iii. 1, 1890.

AENEAS TACTICUS

VIII.

Μετὰ δὲ ταῦτα εἰς τὴν χώραν προσδεχόμενον πλείω καὶ μείζω δύναμιν πολεμίων πρῶτον μὲν τὴν χώραν δυσεπίβολον εἶναι τοῖς πολεμίοις καὶ δυσ-στρατοπέδευτον καὶ δυσπροσπόριστον κατασκευάζειν καὶ τοὺς ποταμοὺς δυσδιαβάτους καὶ πλείους.¹

- 2 Πρὸς τε τὰς ἀποβάσεις τῶν πολεμίων εἰς τὰ ψαμμώδη καὶ στερεὰ ὅσα καὶ ὅλα χρή κατασκευάζεσθαι δολώματα τοῖς ἀποβαίνουσι, τοῖς τε ἐν τῇ χώρᾳ καὶ τῇ πόλει λιμέσιν ὅλα εἰς τούτους δεῖ φράγματα παρασκευάζεσθαι πρὸς τὸ μὴ εἰσπλεῖν ἢ τὰ εἰσπλεύσαντα μὴ δύνασθαι ἐκπλεῦσαι,
- 3 τὰ τε καταλιμπανόμενα ἐν τῇ χώρᾳ ἐκουσίως, εἰς χρεῖαν δὲ φέροντα τοῖς ἐναντίοις, ὅσον πρὸς² τειχοποιίαν ἢ σκηνοποιίαν ἢ ἄλλην τινὰ πρᾶξιν ὡς
- 4 δεῖ³ ἀχρεῖα ποιεῖν ἢ μὴ⁴ φθείροντα ἀφανίζειν τὰ τε βρωτὰ καὶ ποτὰ καὶ τὰ κατ' ἀγροὺς ἔγκαρπα⁵ καὶ τὰ ἄλλα⁶ κατὰ τὴν χώραν, καὶ τὰ⁷ στάσιμα ὕδατα ὡς ἄποτα δεῖ ποιεῖν, τὰ τε ἰππασίμα τῆς
- 5 χώρας ὡς δεῖ ἀνιππα ποιεῖν, περὶ μὲν οὖν τούτων πάντων ὡδε μὲν νῦν παραλείπεται, ὡς δεῖ ἕκαστον τούτων γίνεσθαι, ἵνα μὴ καὶ ταύτῃ, λίαν πολλά, δηλῶται.⁸ γέγραπται δὲ τελέως περὶ αὐτῶν ἐν τῇ Παρασκευαστικῇ βίβλῳ.

¹ ἀπλεύστους Orelli: ἀπλοῖους Meineke (ἀπλόους Koester): ἐλαίους Haupt: δύσπλοισ Hercher.

² Hertlein: πρὸς τε M.

³ Casaubon: ὡσδὲ M.

⁴ Added by Haase; cf. ch. 21.

⁵ R. Schöne indicates a lacuna here.

⁶ πάντα R. Schöne.

⁷ καὶ τὰ added by Meineke.

⁸ Orelli: δηλοῦται M.

VIII.

Next, if the invasion of a more numerous and larger force of the enemy is expected, first, the region must be made difficult for the enemy to attack, to encamp in, and to forage in, and the rivers must be made hard to ford and swollen.¹

The number and kinds of stratagems to be employed against enemies disembarking on sandy and rocky shores; what kind of barriers must be ready against them at the harbour of the country or of the city so that vessels cannot enter, or, if they do, cannot sail out; how to make useless the material voluntarily left in the country which might be useful to the foe, for example, that for building walls or huts, or any other enterprise; or, if it is not destroyed, how to conceal both food and drink, the products of the fields and other things in the country; and how one must make standing² waters undrinkable, and places fit for cavalry movements unfit for them,—the particular treatment of all these subjects is for the present omitted, to avoid explaining them at this point, since they are too numerous. They have been fully treated in the book on *Military Preparations*.

¹ For this idiomatic use of *πολύς* for a thing in violent motion compare especially Demosthenes, *De corona*, 136 *πολλῶ βέοντι*, and Plutarch, *Agésilauis*, 32 *ἐρρύη δὲ πλείστος . . . ὁ Εὐρώτας*. The manœuvres intended are probably damming up stream courses or breaking dikes, so that the rivers would occupy more beds, channels, or depressions, and thus become literally 'larger.' Notable examples of the same thing in the recent war have occurred on the Yser, the Piave, and the Scarpe.

² That is lakes, pools, wells, and cisterns; not 'stagnant' water.

AENEAS TACTICUS

IX.

Ἄν δὲ θρασύνεσθαί τι ἐπιχειρῶσιν οἱ ἐπιόντες πρὸς σε, τάδε ποιητέον. πρῶτον μὲν χρή σώμασι τόπους τινὰς τῆς οἰκείας χώρας καταλαβεῖν, ἔπειτα ἐκκλησιάσαντα τοὺς αὐτοῦ¹ στρατιώτας ἢ πολίτας ἄλλα τε προειπεῖν αὐτοῖς, ὡς ὑπαρχούσης τινὸς αὐτοῖς πράξεως εἰς τοὺς πολεμίους, καὶ ὅταν νυκτὸς σημάνῃ τῇ σάλπιγγι, ἐτοίμους εἶναι τοὺς ἐν τῇ ἡλικίᾳ, ἀναλαβόντας τὰ ὄπλα καὶ ἀθροισθέντας εἰς χωρίον ῥητὸν ἔπεσθαι τῷ ἡγου² μένω. διαγγελθέντων οὖν τούτων εἰς τὸ στρατόπεδον τῶν πολεμίων ἢ τὴν πόλιν, δύνασαι³ ἀπο³ τρέψαι ὧν ἐπιχειρῶσι πράσσειν. τούτων δὲ οὕτω πραχθέντων τοῖς μὲν φιλίσις θάρσος ἐμποιήσεις³ ἐπιχειρῶν τι ἄλλ' οὐ⁴ δεδιώς, τοῖς δὲ πολεμίσις φόβον ἐμπαρασκευάσεις, ὥστε⁵ ἐπὶ τῆς αὐτῶν⁶ ἡρεμεῖν.

X.

Δεῖ δὲ καὶ τάδε παρηγγέλθαι τῶν πολιτῶν τοῖς κεκτημένοις ζεύγη ἢ ἀνδράποδα ὑπεκτίθεσθαι εἰς τοὺς προσοίκους, ὡς οὐκ εἰσαξόντων⁷ εἰς τὴν² πόλιν. οἷς δ' ἂν μὴ ὑπάρξῃ ξενία παρ' οὓς θήσονται, τοὺς⁸ ἄρχοντας δημοσίᾳ παρατίθεσθαι τοῖς προσοίκους, παρασκευάζοντας δι' ὧν σωθήσεται τὰ ὑπεκτιθέμενα.

¹ Casaubon: αὐτοῦ M.

² Casaubon: δυνανται M: δύναται Herm. Schöne.

³ Meier: ἐμποιήσεως M.

⁴ Casaubon: ἐπιχειρῶντι ἄλλου M.

IX.

If the invaders try to overawe you, your first action must be to occupy certain places in your own country with men, and calling an assembly of your own soldiers or citizens, explain the situation to them, telling them that there is some operation on hand for them against the enemy and that when a signal is given by trumpet at night those of military age are to be ready to take arms, gather in an appointed place, and follow their leader. So when this is reported to the camp of the enemy, or to their city, you can divert them from what they are attempting to do. If these things are so done you will inspire your friends with courage by your initiative and fearlessness and arouse fear in your enemies so that they will remain quietly at home.

X.

One must also notify those citizens who own cattle or slaves to place them in safety among neighbours, since they cannot bring them into the city. The authorities at public expense must place such property with neighbouring peoples and provide means for its support if the owners have no friends to whom they may entrust it.

⁵ Added by Casaubon.

⁶ Hertlein: *αὐτῶν* M.

⁷ Casaubon: *εἰσαξιόντων* M.

⁸ Hertlein: *πρὸς τοὺς* M.

AENEAS TACTICUS

[Κηρύγματα]

3 Ἐπειτα κηρύγματα ποιῆσθαι τοιάδε διά τινος χρόνου, φόβου καὶ ἀποτροπῆς τῶν ἐπιβουλευόντων ἕνεκεν. κατακομίζειν τὰ ἐλεύθερα σώματα καὶ τοὺς καρποὺς ἐν τῇ πόλει, τοῦ δὲ ἀνηκουστοῦντος ἐξουσίαν εἶναι τῷ βουλομένῳ ἀζήμια ἄγειν καὶ
4 φέρειν τὰ ἐκ τῆς χώρας. τὰς τε ἑορτὰς κατὰ πόλιν ἄγειν, συλλόγους τε ἰδίους μηδαμοῦ μήτε ἡμέρας μήτε νυκτὸς γίνεσθαι, τοὺς δὲ ἀναγκάιους ἢ ἐν πρυτανείῳ¹ ἢ ἐν βουλῇ ἢ ἐν ἄλλῳ φανερωῶ τόπῳ. μηδὲ θύεσθαι μάντιν ἰδίᾳ ἄνευ
5 τοῦ ἄρχοντος. μηδὲ δειπνεῖν κατὰ συσσιτίαν ἀλλ' ἐν ταῖς αὐτῶν² οἰκίαις ἐκάστους, ἔξω γάμου καὶ περιδείπνου, καὶ ταῦτα προαπαγγείλαντας τοῖς ἄρχουσιν.

Ἐὰν δὲ ὦσιν φυγάδες, ἐπικηρύσσειν, ὅς ἂν ἀστῶν ἢ ξένων ἢ δούλων ἀποκινῆ, ἃ ἐκάστῳ
6 τούτων ἔσται. καὶ εἰάν τις τινι τῶν φυγάδων συγγένηται ἢ παρ' ἐκείνων τισὶν ἢ ἐπιστολὰς πέμψῃ ἢ δέξῃται, εἶναί τινα κίνδυνον ἢ ἐπιτίμιον

¹ Casaubon : πρυτανείῳ M.

² Köchly and Rüstow : αὐτῶν M.

¹ That is, within the walls, since many Greek festivals, then, as now, were held at sacred spots in the countryside.

² So as to avoid unauthorized efforts to foretell the future. The unwelcome prophecies of those who did not represent the 'patriotic' point of view, might be very disconcerting, as well-known instances from the Old Testament show. Similarly under the Roman Empire the charge of merely having had a horoscope prepared was sometimes regarded as sufficient warrant for putting a prominent and ambitious man out of the way.

³ The exception made is due to the marked religious character of these particular feasts. The meal, attended by

AENEAS THE TACTICIAN, x. 3 - 6

[Proclamations]

Furthermore, proclamations such as these are to issued from time to time to frighten and deter conspirators: The free population and the ripe crops are to be brought into the city, authority being given to anyone so disposed to lead away or carry off from the country, without fear of punishment, the possessions of anyone who disobeys this regulation. The usual festivals are to be celebrated in the city,¹ and private gatherings shall not take place, either by day or by night, but those which are really necessary may be held in the town-hall, the council-chamber, or other public place. A soothsayer shall not make sacrifice on his own account without the presence of a magistrate.² Men shall not dine in common but each in his own house, except in the case of a wedding or a funeral feast,³ and then only upon previous notice to the authorities.

If there are any citizens in exile, announcement is to be made what is to be done with each citizen, stranger, or slave who may try to leave.⁴ And if any person associate with any of the exiles, or in dealing with any of them send or receive letters, there is to be a definite risk or even a penalty awaiting him. Out-

large numbers of guests, was an essential feature, serving originally, no doubt, to secure as many competent witnesses as possible to the fact and the good faith of the transaction. Even after a battle the funeral meal might be held in the house of some private person very closely associated in some responsible way with the enterprise. Thus after the battle of Chaeronea in 338 B.C. the funeral feast was held in the house of Demosthenes (*De corona*, 288).

⁴ For the purpose namely of getting in touch with those exiles, the most dangerous class of enemies to the established government.

AENEAS TACTICUS

αὐτῶ. τῶν δὲ ἐκπεμπομένων καὶ εἰσαγομένων ἐπιστολῶν εἶναι ἐπισκόπησιν, πρὸς¹ οὓς οἰσθή-
 7 σεται πρότερον. ὄπλα οἷς ἐστὶν ἐνὸς πλείω ἀπογράφεσθαι, καὶ ἐξάγειν μηδένα μηδὲν ὄπλον, μηδὲ ἐνέχυρον δέχεσθαι. στρατιώτας μὴ μισθοῦσθαι μηδὲ ἑαυτὸν μισθοῦν ἄνευ τῶν ἀρχόντων.
 8 ἐκπλεῖν μηδένα ἀστῶν μηδὲ μέτοικον ἄνευ συμβόλου, τά τε πλοῖα προπαρηγγέλλαι² ὀρμίζεσθαι
 9 καθ' ἃς πύλας ἐν τοῖς ἐχομένοις ῥηθήσεται. ξένους τοὺς ἀφικνουμένους τὰ ὄπλα ἐμφανῆ καὶ πρόχειρα φέρειν, καὶ εὐθύς³ αὐτῶν παραιρεῖσθαι,⁴ καὶ αὐτοὺς μηδένα ὑποδέχεσθαι, μηδὲ τοὺς πανδοκέας,⁵ ἄνευ τῶν ἀρχόντων, τοὺς δὲ ἄρχοντας ἀπογράφεσθαι καὶ παρ' ᾧ τίνες,⁶ ὅταν⁷ κατάγωνται.
 10 τὰς δὲ νύκτας ὑπὸ τῶν ἀρχόντων τὰ πανδοκεῖα⁸ ἕξωθεν κλείεσθαι. διὰ χρόνου δέ τινος, ὅσοι ἂν ταλαπέριοι αὐτῶν ᾦσιν,⁹ ἐκκηρύττεσθαι. ὁμόρους δὲ ἢ κατὰ παιδείωσιν ἢ κατ' ἄλλην τιὰ χρεῖαν
 11 ἐπιδημοῦντας ἀπογράφεσθαι. ταῖς δὲ δημοσίαις ἀφικνουμέναις πρεσβείαις ἀπὸ πόλεων ἢ τυράννων ἢ στρατοπέδων οὐ χρῆ ἐν αὐτοῖς¹⁰ τὸν ἐθέλοντα διαλέγεσθαι, ἀλλ' αἰεὶ παρεῖναι¹¹ τινὰς τῶν πολιτῶν τοὺς πιστοτάτους, οἱ μετ' αὐτῶν συνδιατελοῦσιν¹²

¹ C: πρὸς M.

² Hertlein: προσηγγέλλαι M.

³ Hercher: εὐθύ M.

⁴ Reiske: παρήσθαι M (cf. 30. 2).

⁵ Hertlein: πανδοχέας M.

⁶ Herm. Schöne: ὅτινες M.

⁷ Köchly and Rüstow: ὅταν ἂν M.

⁸ Hertlein: πανδοχεῖα M.

⁹ B: ὡσεὶ M.

¹⁰ Herm. Schöne: αὐτοῖς M.

¹¹ Suggested by R. Schöne.

¹² Reiske: συντελοῦσιν M.

AENEAS THE TACTICIAN, x. 6 - 11

going and incoming letters shall be brought to censors before being sent out or delivered.¹ Men who have more than one equipment of arms shall return a list of them, and no one shall send any weapon out of the city or receive such as security. Soldiers may not be hired nor may one serve for hire without the permission of the authorities. No citizen or resident alien shall take passage on a ship without a passport,² and orders shall be given that ships shall anchor near gates designated in what follows. Strangers arriving shall carry their weapons unconcealed and ready at hand, and immediately upon arrival shall be disarmed, while no one, not even the innkeepers, shall receive them without permission from the authorities, who shall record also in whose house any persons are, when they take lodging; and at night inns must be locked from the outside by the authorities. From time to time vagrants among these strangers shall be publicly expelled. Citizens of neighbouring states, however, residing in the city for the sake of education³ or for some other special purpose, shall be registered. Not everyone who wishes may converse with public embassies representing cities, princes, or armies, but there must always be present certain of the most trusted citizens who shall stay with the ambas-

¹ Plautus in the *Trinummus* (from Philemon †c. 263 B.C.), vv. 793-5 makes mention of *portitores* who even in time of peace might break the seals and inspect letters.

² The first mention of such a passport is in the *Birds* of Aristophanes (414 B.C.), vv. 1212-15, where it would seem that a *σφραγίς* or visé by an officer was also required.

³ That is, in the larger places mainly students, but in the ordinary cities for which Aeneas wrote more likely visiting sophists, philosophers, music teachers, and the like.

AENEAS TACTICUS

- 12 μέχρῃς ἂν ἐνδήμῳσι οἱ πρέσβεισ. καὶ ὧν ἂν σπανίζῃ ἢ πόλισ, σίτου ἢ ἐλαίου ἢ ἄλλου τινός, τῷ εἰσάγοντι κατὰ πλήθος τῶν εἰσαγομένων τόκουσ προκεῖσθαι καὶ στέφανον δίδουσθαι εἰσ τιμῆν, τῷ δὲ ναυκλήρῳ ἀνολκῆν καὶ καθολκῆν.¹
- 13 ἐξοπλισίασ τε πυκνὰσ ποιεῖσθαι, καὶ ξένουσ τοὺσ ἐνδήμουσ τὸν καιρὸν τοῦτον μεθίστασθαι εἰσ χωρίον ῥητὸν ἢ κατ' οἶκον διατελεῖν· ἢ δὲ ἂν ἄλλῃ² φαίνηται, ζημίαν προκεῖσθαι ὡσ ἀδικουῖντι.
- 14 ὅταν τε σημήνῃ, τούτοισ τὰ³ ἐμπόρια καὶ πρατήρια κλείεσθαι, καὶ τὰ λύχνα κατασβέννουσθαι, καὶ τῶν
- 15 ἄλλων μηδένα ἔτι παρεῖναι.⁴ ὅταν δὲ τιμι ἀναγκαιόν τι συμβῇ, μετὰ λαμπτήροσ βαδίζειν, ἕωσ ἂν ἀντιπαραγγελθῇ.⁵ καὶ ὅσ ἂν καταμηνύσῃ τινὰ ἐπιβουλεύοντα τῇ πόλει, ἢ ὅ τι ἂν τῶν προγεγραμμένων τισ πραττόμενον ἐξαγγείλῃ, ἀνηγγέλθαι τε αὐτῷ ἀργύριον καὶ τὸ ἀγγελθὲν ἐμφανῶσ προκεῖσθαι ἐν ἀγορᾷ ἢ ἐπὶ βωμοῦ ἢ ἐν ἱερῷ, ἵνα προχειρότερόν τισ τολμήσῃ μηνύειν τι τῶν προγεγραμμένων.
- 16 Ἐπὶ δὲ μονάρχῳ ἢ στρατηγῷ ἢ φυγάδι δυναστεύοντι χρῆ καὶ τάδε προκηρύττεσθαι⁶

¹ Casaubon: καθολικῆν M.

² Casaubon, Behrendt: ἢ δε, ἀν ἄλλῃ M.

³ Meineke, Schenkl: τὰ τούτοισ M.

⁴ παριέναι Meineke: προῖέναι Hercher.

⁵ R. Schöne: παραγγελθῇ M.

⁶ Köchly and Rüstow indicated the lacuna.

¹ This seems to be the earliest instance of profit-fixing (and hence price-fixing) as a special war measure. Casaubon thought that the purpose was to prevent profiteering; Köchly and Rüstow on the other hand, that it was to

AENEAS THE TACTICIAN, x. 11 - 16

sadors so long as they remain. For the importer of whatever the city lacks, grain or oil or anything else, profits shall be specified in proportion to the amount of his importations,¹ and he shall be honoured with a crown, and the shipmaster shall be granted allowance for the hauling up and down of his vessel.² Frequent calls to arms shall be given and all strangers in the town shall at this time assemble in a specified place or remain indoors; if, however, one of them shall appear elsewhere, a penalty shall be prescribed for him as a malefactor. At a given signal their stores and shops shall be closed and their lights extinguished, and no one else shall come in. Whenever it is necessary for anyone, he may go out with a lantern, until orders are issued to the contrary. For whoever points out anyone conspiring against the city, or reports anyone as doing any of the things above-mentioned, a reward in money shall be announced, and the reward shall be displayed openly in the market-place or on an altar or in a temple, in order that men may the more readily venture to report any violation of the provisions mentioned.

Concerning a sovereign, a general, or a fugitive ruler one should make also the following proclama-

encourage capitalists to undertake the serious risks involved in supplying a city during war-time. It seems most reasonable to suppose that the setting of a fixed percentage of profit which must have been guaranteed by the state would act both to "encourage production," that is, in this case, importation, and to keep down prices as well.

¹ In ancient times, as now, the bulk of the foodstuffs transported in Greece was carried in light coasting vessels which were pulled up on shore when not in use. Aeneas probably has in mind the charges for this hauling up and down, and not ordinary harbour tolls, as is generally assumed.

AENEAS TACTICUS

- ἐὰν δέ τι καὶ αὐτὸς πάθῃ ὁ ἀποκτείνων, τοῖς τέκνοις αὐτοῦ ἀποδίδοσθαι τὸ ἀγγελθὲν ἀργύριον·
- 17 ἐὰν δέ μὴ ἢ τέκνα, τῷ ἐγγυτάτῳ γενομένῳ.¹ καὶ εἴαν τις τῶν συνόντων τῷ φυγάδι ἢ μονάρχῳ ἢ στρατηγῷ πράξῃ τι . . .² τῶν προκειμένων ἀποδίδοσθαι καὶ κάθοδον αὐτῷ εἶναι· διὰ γὰρ ταῦτα
- 18 προχειροτέρως ἂν ἐγχειροῖεν. ἐν³ δὲ ξενικῷ στρατοπέδῳ τοιάδ', ἀναγγείλαντα⁴ σιγῆν, πάντων
- 19 ἀκουόντων κηρῦξαι. εἴ τις βούλεται ἀπιέναι, μὴ ἀρεσκόμενοι⁵ τοῖς παρούσιν, ἐξεῖναι ἀπαλλάττεσθαι· ἀλλ' ὕστερον⁶ . . .⁷ πεπωλήσεται· τὰ δ' ἐλάσσω τούτων ἀδικήματα, κατὰ τὸν νόμον τὸν προκειμένον δεσμὸς ἢ⁸ ζημία. ἐὰν δέ τις φαίνηται βλάβπτων τι τὸ στράτευμα, διαλύων τὸ στρατό-
- 20 πεδον, θάνατος ἔστω ἢ⁹ ζημία. μετὰ δὲ ταῦτα τῶν ἄλλων τάξεων ἐπιμέλειαν ποιητέον. καὶ πρῶτον ἐπισκεπτέον εἰ ὁμονοοῦσιν οἱ πολῖται, ὡς ἂν ὄντος μεγίστου τούτου ἀγαθοῦ ἐν πολιορκίᾳ· εἰ δὲ μὴ, τῶν τὰ ἐναντία φρονούντων τοῖς παρούσι
- ¹ γένει Reiske: γένει or γένους Kirchhoff: γένους Hercher.
² Hercher indicated the lacuna: R. Schöne suggests very plausibly τὸ ἡμισυ, which the translation follows.
³ Orelli: ἐὰν M. ⁴ Meier: ἀναγγείλαντι M.
⁵ ἀρεσκόμενος Casaubon. ⁶ ὕστερων Wünsch.
⁷ R. Schöne indicated the lacuna.
⁸ Orelli: ἢ M. ⁹ AC: ἢ M.

¹ Obviously the reward of the assassin has been lost here, the general character of which can be learned from other sources. Thus in the decree of Demophantus at Athens, in 410-9 B.C., the assassin was to be regarded innocent of all crimes or guilt and to receive one-half of the confiscated estate of the tyrant, while if he perished in the attempt his children were to be treated like the descendants of Harmodius and Aristogeiton, that is, maintained and honoured at the public expense (Andocides, *De mysteriis*, 93 ff.; Demo-
58

tions¹: If the tyrannicide himself come to grief, the reward announced shall be paid to his children, and if he have none, to his next of kin. And if anyone of the associates of the exile or sovereign or general do some [service to the state, one-half of] the reward shall be paid him and a return to his home shall be granted, for because of these considerations he would the more readily make the attempt. In a mercenary force, after a call for silence, the following shall be proclaimed in the hearing of all: If anyone is displeased with the existing conditions, and wishes to withdraw, he may do so, but afterwards . . . he will be sold into slavery. For offences less than these imprisonment shall be the penalty, according to the existing law. If anyone be shown to be injuring the army or demoralizing the camp, death shall be the penalty. Then attention shall be given to the other classes. First, one must note whether the citizens are of one mind, since that would be of greatest advantage during a siege. If not, one must, without arousing suspicion, remove [the most

sthenes xx. 159). At Ilium, early in the third century, the rewards are most detailed and explicit. The tyrannicide is to receive a talent of silver and have a bronze statue erected in his honour; he shall be kept at the public expense; at contests called to the front seat by name; and receive a pension of two drachmas a day as long as he lives. A foreigner is to receive citizenship in addition to these rewards, while a slave is given his freedom, one half talent of silver, and (probably) one drachma a day as pension (Inscr. in Dittenberger's *Orientalis Graeci Inscr. Sel.* no. 218, ll. 19 ff.). Fragments of a similar decree from Eretria at about the middle of the fourth century B.C. have also been published (see A. Wilhelm, *Jahresh. d. österr. arch. Inst.* 8 (1905), pp. 13 ff.), and for Erythrae, in the age of Cimon (*I.G.* i. 9). For a general discussion of such legislation see *Recueil des inscr. jurid. grecques* ii. (1898), pp. 25-57.

AENEAS TACTICUS

- πράγμασι . . .¹ καὶ μάλιστ' ἂν² ἡγεμόνας τε καὶ αἰτίους γενομένους ἐν τῇ πόλει πράξεώς τιως μεθιστάναι αὐτοὺς ἀνυπόπτως μετὰ προφάσεως εὐλόγου ἐκπέμποντα ἄλλη ὡς πρέσβεις τε καὶ
- 21 ἐπ' ἄλλας δημοσίας ἐργασίας. οἷον καὶ Διονύσιος ἔπραξεν Λεπτίνην τὸν ἀδελφὸν αὐτοῦ, ἔχοντα Συρακοσίων³ τῷ πλήθει οἰκείως καὶ ὄρων κατὰ πολλὰ ἰσχυρὸν αὐτὸν ὄντα· γενόμενος αὐτῷ ἐν⁴ ὑποψία τινί, καὶ θέλων αὐτὸν μεταστῆσασθαι, φανερώς μὲν οὐκ ἐπεχείρει ἐκβάλλειν αὐτόν, γνοὺς ὅτι περὶ αὐτὸν πολλὴ μετ' εὐνοίας ἰσχὺς ἔσοιτο καὶ νεώτερον ἂν τι γένοιτο· τεχνάζει δὲ
- 22 τοιόνδε. πέμπει αὐτὸν μετὰ ξένων ὀλίγων εἰς πόλιν ὄνομα Ἰμέραν, κελεύων φρουρὰν τὴν μὲν ἐξαγαγεῖν τὴν δὲ καταστῆσαι. γενομένου δὲ αὐτοῦ ἐν τῇ Ἰμέρα, πέμψας ἐκέλευσεν αὐτὸν περιμένειν, μέχρις ἂν αὐτὸς μεταπέμψηται.
- 23 Πόλεως δ' ὀμηρευομένης, ὅταν ἐπ' αὐτὴν στρατεία⁵ γίγνηται, τοὺς γονεῖς τῶν ὀμηρευόντων καὶ τοὺς ἐγγυὺς τὰ γένη⁶ μεθίστασθαι ἐκ τῆς πόλεως, ἄχρῖς ἂν ἡ πολιορκία παρέλθῃ, ἵνα μὴ ἐφορῶσιν ἐν ταῖς προσαγωγαῖς τῶν πολεμίων τοὺς αὐτῶν⁷ παῖδας συμπροσαγομένους καὶ τὰ ἔσχατα πάσχοντας· ἐγχωρεῖ γὰρ αὐτοὺς εἶδον ὄντας καὶ

¹ Köchly and Rüstow indicated the lacuna: Herm. Schöne suggested τοὺς δυνατωτάτους, which the translation follows.

² Hercher: μάλιστα M.

³ Meineke: Συρακουσίων M.

⁴ Added by Casaubon.

⁵ Hertlein: στρατιά M.

⁶ ἐγγύτατα γένοι Kirchoff.

⁷ Köchly and Rüstow: αὐτῶν M.

influential of] those out of sympathy with the existing order of things, especially those who might become leaders and responsible for action in the city, sending them away somewhere on a plausible pretext, as ambassadors or on other public business. For instance, Dionysius did this in the case of his brother Leptines, when he saw that he was popular with the people of Syracuse and in many ways influential. Becoming suspicious of him and desiring to get rid of him, he did not openly attempt to expel him, for he knew that he would have great support and favour and that a revolution might ensue, so he devised this scheme. He sent him with a few mercenaries to a city named Himera, directing him to bring back part of its garrison and reorganize the rest. When he arrived at Himera, Dionysius sent him word to stay there until he sent for him.¹

When a city has given hostages and a campaign is made against it, the parents and next of kin of the hostages should depart from the place until the siege is over, in order that they may not, in the assaults by the enemy, see their own sons brought forward and meeting a cruel end. For it is possible that these people, if they were in the city, might go

¹ The Dionysius mentioned here is the first of that name (405-367). The event mentioned occurred probably in 397 B.C., the year in which Himera came over to Dionysius (Diodorus, xiv. 47. 6), or soon thereafter, at all events before the battle of Cronium, in 383 B.C., in which Leptines lost his life (Diodorus xv. 17. 1). From the phrase used by Diodorus, *μεθ' οὗς Ἴμεραίου μετεπέμψατο* (xiv. 47. 6), it would seem that this might be the very occasion referred to by Aeneas, although it is possible that the year 386 B.C. is meant, at which time Dionysius I sent Leptines and Philistus into exile (Diodorus xv. 7. 3).

AENEAS TACTICUS

- 24 ὑπεναντίον τι πράξει. ἐὰν δὲ ἄρα δυσχερὲς¹ ἦ² μετὰ τῶνδε τῶν προφάσεων ἐκπέμπειν, συνδιάγειν αὐτοὺς ὡς ἐλαχίστων μετέχοντας ἔργων καὶ πράξεων καὶ μήτε ὅπου ἔσονται μήτε ὅ τι πράξουσιν προειδέναι, καὶ ὡς ἥκιστα ἐπὶ σφῶν αὐτῶν διατηροῦντας καὶ νύκτα καὶ ἡμέραν· καὶ ἄλλας ἐπ' ἄλλαις³ πράξεις καὶ λειτουργίας αὐτοῖς τὸ πλῆθος ἐπιρρεῖν ἀνυπόπτως, μεθ' ὧν ὄντες ἐν
- 25 φυλακῇ μᾶλλον ἔσονται ἢ φυλάξουσὶ τι. ἔστωσαν δὲ διειληγμένοι ὡς εἰς παρατήρησιν⁴· οὕτως γὰρ ἂν διακεῖμενοι ἥκιστα ἂν δύναιτο νεωτερίσαι.

Ἔτι τοίνυν μηδὲ εἰς τὰς κοίτας λαμπτήρας φέρεσθαι μηδὲ ἄλλο νυκτερινὸν φέγγος· ἤδη γάρ τινες, ἐπεὶ πάντῃ⁵ ἐξείργονται μηδὲν⁶ νεωτερίσαι, θέλοντες, μηδὲ πρὸς τοὺς πολεμίους τι πράξει,

26 τοιόνδε τεχνάζουσι. σὺν γὰρ τοῖς καλάθοις⁷ καὶ στρώμασι φερόμενοι⁸ εἰς τὰς φυλακὰς λύχνα οἱ δὲ δᾶδας οἱ δὲ λαμπτήρας, ἵνα δῆ⁹ πρὸς τι κοιτασθῶσιν, διὰ¹⁰ τούτων τῶν φεγγέων¹¹ σύσσημον ἐποιήσαντο· διὸ δεῖ πάντα τὰ τοιαῦτα ὑποπτεῦειν.

XI. [Ἐπιβουλαί]

Ἔτι δὲ καὶ τῶν πολιτῶν δεῖ τοῖς¹² ἀντιπροθυμουμένοις προσέχειν τὸν νοῦν καὶ μηδὲν εὐθέως¹³ ἀποδέχεσθαι διὰ τάδε. ῥηθήσονται δὲ ἐξῆς αἱ

¹ Casaubon : δυσχερῆς M.

² Added by Köchly and Rüstow.

³ Reiske : ἐπάλλας M.

⁴ Köchly and Rüstow : ὡσεὶ παρὰ τρισὶν M.

⁵ Casaubon : ἐπὶ πάντῃ M.

⁶ Casaubon : μηδὲ M.

⁷ Orelli : ἀκολούθοις M.

⁸ Haase : φερομένοις M.

⁹ Casaubon : δὲ M.

¹⁰ Added by Hercher.

so far as to engage in some act of opposition. If, however, it prove difficult to send such persons out on these pretexts, they must continue in the city but share in only the fewest possible works and undertakings, and they must not know in advance where they are to be or what they are to do, being as little as possible their own masters by night and day. And on one duty and special service after another, without raising suspicion, many persons should keep coming and going about them, in whose company they will be under guard rather than on guard. But let them be divided, so that they may be kept under watch, for in this manner they would be least able to begin a revolution.

Again, citizens are not to go to bed with lamps or any light at night, for in some instances persons who have been thwarted in every way from beginning a revolution (which was what they wished), and from entering into negotiations with the enemy, have contrived thus: carrying lights to their positions on guard-duty, along with their baskets and bedding — sometimes taking torches, sometimes lamps — ostensibly in order to have some light to go to bed by, they have by these lights given a pre-arranged signal. Accordingly, all such matters must be regarded with suspicion.

XI. [Plots]

One must, further, keep an eye on those of the citizens who are disaffected and not be too ready to accept their advice. To show this, I shall here

¹¹ Hercher (φεγγῶν: φεγγέων Behrendt): τοῦτον τὸν φεγγαῖον M.

¹² R. Schöne: τοῖς δεῖ (with indication of wrong order) M.

¹³ εὐήθως (cf. xxviii. 7) Herm. Schöne.

AENEAS TACTICUS

ἐπιβουλαὶ ἐκ τῆς βίβλου¹ παραδείγματος ἔνεκεν, ὄσαι κατὰ πόλιν ἐξ ἀρχόντων ἢ ἰδιωτῶν γεγόνασιν καὶ ὡς ἔναι αὐτῶν κωλυθεῖσαι διελύθησαν.

- 3 Χίου γὰρ μελλούσης προδίδοσθαι, τῶν ἀρχόντων τις, συμπροδιδούς καὶ ἀπατῶν τοὺς συνάρχοντας² ἔπεισε λέγων, ὡς, ἐπειδὴ εἰρήνη εἴη, τοῦ τε λιμένος τὸ κλειθρον εἰς γῆν ἀνασπασαντας ξηρᾶναι δεῖ καὶ πισσαλοιφῆσαι καὶ τὰ παλαιὰ τῶν νεῶν ἄρμενα ἀποδόσθαι, τῶν τε νεωρίων ἐπεσκευάσθαι τὰ στάζοντα καὶ τὴν ἐχομένην αὐτῶν στοᾶν καὶ τὸν πύργον, ἐν ᾧ διητῶντο οἱ ἄρχοντες, ἐχόμενον τῆς στοᾶς, ἵνα ἐκ προφάσεως κλίμακες προπορισθῶσιν³ τοῖς μέλλουσι καταλαμβάνειν τὰ
- 4 νεώρια καὶ τὴν στοᾶν καὶ τὸν πύργον. ἔτι δὲ συνεβούλευε καὶ τὸ πλῆθος τῶν τὴν πόλιν φυλασσόντων ἀπόμισθον ποιῆσαι, ἵν' ὡς ἐλάχιστον
- 5 δῆθεν ἀνάλωμα τῇ πόλει ᾗ.⁴ καὶ ἄλλα τούτοις ὁμότροπα λέγων ἔπεισε τοὺς συνάρχοντας ἄπερ ἔμελλεν⁵ τοῖς προδιδούσι καὶ ἐπιτιθεμένοις⁶ συνοίσειν πρὸς τὴν κατάληψιν· ὥστε αἰεὶ δεῖ προσέχειν τοῖς τὰ τοιαῦτα τελειοῦν⁷ σπουδάζουσιν.
- 6 ἅμα δὲ τοῦ τείχους ἐκδήσας⁸ κατεκρέμασε δίκτυα ἐλάφεια καὶ σύεια, ὡσεὶ ξηρᾶναι θέλων, καὶ ἄλλη ἰστία⁹ ἔξω τοὺς κάλους ἔχοντα· καθ' ἅπερ ἐν νυκτὶ ἀνέβησαν στρατιῶται.

¹ ποριστικῆς βίβλου Hercher: πολιτικῆς Köchly and Rüstow: Casaubon thought of the ἀκούσματα: R. Schöne with great probability suggests an ἐπιβουλῶν βίβλος.

² Casaubon: ἀρχοντας M.

³ R. Schöne: προσπορισθῶσιν M.

⁴ Casaubon: ἡ M.

⁵ Meineke: ἔμελλον M.

⁶ Köchly and Rüstow: ἐπιθεμένοις M.

⁷ B²C: λειοῦν M.

⁸ Haupt: ἐπιδήσας M.

⁹ Orelli: σύεια M.

AENEAS THE TACTICIAN, xi. 2-6

note in order and by way of example, from the book on this subject, how many plots have been made within various cities by officials or by private citizens, and how some of these have been completely frustrated.

Just before the betrayal of Chios,¹ one of the officials, who was a party to the act of treason, deceitfully persuaded his colleagues, that, since the state was at peace, they ought to draw the barrier of the harbour up on land for drying and caulking, to sell the old rigging of the ships, and to repair the leaky roofs of the ship-houses as well as of the adjoining arsenal and of the tower next to this arsenal, in which the magistrates took their meals—all as a pretext, so that ladders might be at hand for those who were to seize ship-houses, arsenal, and tower. He further advised that the majority of the men who were doing guard-duty in the city should be paid off, on the pretext that the expense to the state might be as small as possible. With these and similar arguments he won over his colleagues to every measure that would contribute to the victory of the conspirators when they made this seizure. Accordingly, one must always keep an eye on those who are too eager to effect matters of this kind. At the same time he fastened to the wall and hung out, as if for drying, deer nets and boar nets, and in other places sails with the ropes hanging, and it was by these that the soldiers climbed up at night.

¹ Nothing is known further about this event. Chios had tyrants (*Athen.* vi. 259 A, B), and was the scene of frequent and fierce struggles between oligarchs and democrats (*Aristotle, Pol.* 1306 b 3 ff. ; *Aelian, Var. Hist.* xiv. 25).

AENEAS TACTICUS

- 7 Πρὸς δὲ ἀντιστασιώτας τοιόνδε ἐπράχθη ἐν Ἀργεὶ μελλόντων γὰρ τῶν πλουσίων τὴν δευτέραν ἐπιθέσιν ἐπιτίθεσθαι τῷ δήμῳ καὶ ξένους ἐπαγομένων, ὁ τοῦ δήμου προστάτης, προαισθόμενος τὸ μέλλον, τῶν ἐπιθησομένων τινὰς τῶν ὑπεναντίων ὄντων τῷ δήμῳ ἄνδρας δύο προσποιησάμενος φίλους εἶναι ἀπορρήτους, πολεμίους αὐτῷ¹ καθίστησιν αὐτοὺς καὶ ἐποίει κακῶς ἐν τῷ φανερωῷ, σιγῇ δὲ τὰ² ἐκ τῶν ἐναντίων βουλευματα ἤκουεν παρ' αὐτῶν.
- 8 ἐπεὶ δ' ἐν τῷ εἰσάγεσθαι τοὺς ξένους ἦσαν οἱ πλούσιοι, ἅμα δὲ καὶ τῶν ἐν τῇ πόλει τινὲς ἦσαν ἔτοιμοι, καὶ εἰς τὴν ἐπιούσαν νύκτα ἔμελλεν τὸ ἔργον ἔσεσθαι, ἔδοξε τῷ τοῦ δήμου προστάτῃ τὴν³ ταχίστην ἐκκλησίαν συναγαγεῖν καὶ τὸ μέλλον μὴ προειπεῖν, ἵνα μὴ πᾶσα ἡ πόλις ταραχθῇ, εἰπόντα⁴ δὲ ἄλλα τε καὶ ὅτι συμφέρον εἴη ἐν τῇ ἐπιούσῃ νυκτὶ σὺν τοῖς ὅπλοις πάντας Ἀργείους⁵ παρεῖναι
- 9 ἐν τῇ αὐτοῦ⁶ φυλῇ ὄντας ἕκαστον.⁷ εἰάν δέ τις ἄλλως⁸ ἐκθῆται τὰ ὅπλα ἢ ἄλλη ἐξενεγκάμενος φανῇ, ὡς προδότης καὶ ἐπιβουλεύων τῷ δήμῳ
- 10 πασχέτω τι. τοῦτο δὲ αὐτὸ ἵνα κατὰ τὰς φυλαῖς ὄντες οἱ πλούσιοι μὴ δύνωνται εἰς ταῦτ' ἀθροισθέντες μετὰ τῶν ξένων ἐπιθέσθαι, ἀλλ' ἐν ταῖς φυλαῖς ὄντες διακεχωρισμένοι ὣσιν ἐν πολλοῖς ὀλίγοι φυλέταις. καλῶς δὲ δοκεῖ καὶ ἀγχινώως μετ' ἀσφαλείας διαλυῖσαι τὸ μέλλον.

¹ Orelli : αὐτῷ M.

² Casaubon : τὸ M.

³ Added by Schenkli.

⁴ εἰπεῖν Köchly and Rüstow : εἶπεν Herm. Schöne.

⁵ Schöne : M, now illegible, formerly reported to have μὲν οὖσ (?) : ἄγει οὖσ A : ἔχει οὖσ B.

⁶ Köchly and Rüstow : αὐτου M. ⁷ Meier : ἐκατὸν M.

⁸ ἄλλοσε Reiske (ἄλλοσ' R. Schöne).

AENEAS THE TACTICIAN, XI. 7 - 10

Against revolutionists the following plan was carried out in Argos. When the rich men's party was about to launch the second attack¹ against the people and was bringing up mercenaries, the leader of the people's party, who had found out what was about to happen, just before the attack won over two men of the party hostile to the people, to be his secret accomplices, and while publicly treating them as his enemies and abusing them he heard from them in private the plans of the opposing party. Then, when the rich men were in the act of bringing in their mercenaries, and others of their party were at the same time ready within the city, and the deed was to take place the next night, he decided to call an immediate assembly of the people, without announcing what was to come, that the city might not be thrown into utter confusion, and told them, among other things, that it was desirable for all Argives to stand at arms during the coming night, each man with his own tribe. Further, that if anyone should follow a different course in arming himself or should appear elsewhere and out of his proper station, he should be punished as a traitor and conspirator against the people. The purpose of this was that the rich men, scattered among the various tribes, should not be able to assemble at one point and attack with the mercenaries, but should be distributed in the several tribes as a small minority among their fellow-tribesmen. And he seems to have dealt skilfully, cleverly, and safely with the impending danger.

¹ This is probably to be referred (with Hug, *Aeneas von Stymphalus*, p. 6, n. 6) to the revolutions of 370 B.C., that finally ended in the notorious *στυγαλισμός*, in which the people clubbed to death more than a thousand of the oligarchs. See Ed. Meyer, *Gesch. d. Alt.* v. § 948.

AENEAS TACTICUS

- 10^a Παραπλησίως δὲ ἐν Ἡρακλείᾳ τῇ ἐν τῷ Πόντῳ, οὔσης δημοκρατίας καὶ ἐπιβουλευόντων τῶν πλουσίων τῷ δήμῳ καὶ μελλόντων ἐπιτίθεσθαι, προγνόντες οἱ προστάται τοῦ δήμου τὸ μέλλον, οὐσῶν αὐτοῖς τριῶν φυλῶν καὶ τεσσάρων ἑκατοστῶν, ἔπεισαν τὸ πλῆθος ἐξήκοντα εἶναι ἑκατοστύας, ἵνα ἐν ταύταις καὶ εἰς τὰς φυλακὰς καὶ εἰς τὰς ἄλλας
- 11 λειτουργίας φοιτῶσιν οἱ πλούσιοι. συνέβαιεν καὶ ἐνταῦθα διεσκεδασμένους εἶναι τοὺς πλουσίους καὶ ἐν ταῖς ἑκατοστύσιν ὀλίγους¹ ἑκάστοθι παρα-
- 12 γίνεσθαι ἐν πολλοῖς δημόταις· ὁμότροπον δέ τι τούτῳ καὶ πάλαι² ἐν Λακεδαίμονι γενέσθαι.³ μνηυθείσης γὰρ ἐπιβουλῆς τοῖς ἄρχουσιν ὅτι ὅταν ὁ πῖλος⁴ ἀρθῇ ἐπιθήσονται, ἔπαυσαν τοὺς ἐγχειροῦντας ἐπιθέσθαι, κήρυγμα ἀναγγείλαντες τοὺς τὸν πῖλον⁵ μέλλοντας ἄραι μὴ ἄραι.
- 13 Ἐν Κορκύρα δὲ ἐπανάστασιν δέον γενέσθαι ἐκ τῶν πλουσίων καὶ ὀλιγαρχικῶν τῷ δήμῳ (ἐπεδήμει⁶ δὲ καὶ Χάρης Ἀθηναῖος φρουρὰν ἔχων, ὅσπερ⁷ συν-
- 14 ἤθελεν τῇ ἐπαναστάσει) ἐτεχνάσθη τοιόνδε. τῶν τῆς φρουρᾶς τινες ἄρχοντες σικύας προσβαλλόμενοι⁸

¹ Casaubon : ὀλίγοις M.

² Köchly and Rüstow : παλαιὸν M.

³ C : γίνεσθαι M.

⁴ Casaubon : ὅτ' ἂν ὁ πηλὸς M.

⁵ Casaubon : πηλὸν M.

⁶ Casaubon : ἐπιδημεί M.

⁷ Casaubon : ὡσπερ M.

⁸ Casaubon : προσβαλλόμενοι M.

¹ Some details of the party strife are given in Aristotle, *Pol.* 1305 b 2 ff. The date of this particular occurrence is not known. For further experiences of the city see below, xii. 5.

² That is, each of the three tribes (a characteristic of Doric social structure) had four 'hundreds,' or twelve 'hundreds' in all, as in old Athens each of the four tribes was divided into three trittyes or 'thirds.'

AENEAS THE TACTICIAN, XI. 10^a - 14

Similarly, in Heracleia Pontica,¹ when the democracy was in power and the rich were conspiring against it and about to make an attack, the leaders of the popular party, who knew what was imminent, persuaded the people to establish a division into sixty 'hundreds' in place of their former three tribes and four 'hundreds,'² so that, in the new divisions, the rich should do both guard-duty and the other services. The result was that here, too, the rich were scattered, and were, in each 'hundred,' few among many of the popular party. And a similar thing took place long ago in Lacedaemon.³ When the authorities were informed of a conspiracy to attack at the moment when the felt cap⁴ was raised, they thwarted those who planned the attack by giving the men who were about to raise the felt cap the order not to raise it.

In Corcyra a rebellion of the wealthy oligarchic party against the rule of the people (the Athenian Chares, who at that time lived there and commanded the guard, helped in this rebellion) was contrived in the following manner.⁵ Some of the captains of the guard drew blood from themselves

³ This was the dangerous revolution of the Parthenii, or 'half-breeds,' as they might be called, which finally ended in the peaceful colonization of Tarentum, about 708 B.C., according to an untrustworthy legend. See Ed. Meyer, *Gesch. d. Alt.* ii. § 306 A

⁴ The felt cap had probably a symbolic meaning here. It was the headdress of the ordinary free man as such, and seems never to have been worn by slaves, so that its elevation symbolized the assumption of the status of free men. Among the Romans, indeed, one of the formal symbolic acts of manumission was the bestowal of a *pileus*, the Italic equivalent of the Greek *πίλος*.

⁵ This is set in 361 B.C. by Diodorus xv. 95. 3.

AENEAS TACTICUS

καὶ τομὰς ἐν τῷ σώματι ποιησάμενοι καὶ αἱμα-
 τωθέντες ἐξέδραμον εἰς τὴν ἀγορὰν ὡς πληγὰς
 ἔχοντες, ἅμα δ' αὐτοῖς εὐθύς προπαρασκευασμέ-
 νοι οἱ τε ἄλλοι στρατιῶται τὰ ὄπλα ἐξηνέγκαντο
 15 καὶ τῶν Κορκυραίων οἱ ἐπιβουλεύοντες. τῶν
 δ'¹ ἄλλων ἀγνοούντων τὸ πρᾶγμα καὶ εἰς ἐκκλησίαν
 παρακληθέντων συναλαμβάνοντο οἱ προστάται τοῦ
 δήμου, ὡς ἐπαναστάσεως γενομένης² ἐξ αὐτῶν,
 καὶ τὰ ἄλλα μεθίστασαν πρὸς τὸ συμφέρον αὐτοῖς.³

XII. [Περὶ συμμάχων ἃ δεῖ προνοεῖν]

Χρὴ δὲ καὶ συμμάχων εἰς τὴν πόλιν . . .⁴ μήποτε
 ἅμα διατελεῖν τοὺς συμμάχους, ἀλλὰ διεσκεδάσθαι
 ὁμοτρόπως τῶν αὐτῶν ἕνεκεν τοῖς προειρημένοις.
 2 τὸ δὲ αὐτὸ καὶ μετὰ ξένων μισθοφόρων μέλλοντάς
 τι πράσσειν αἰεὶ χρὴ ὑπερέχειν πλήθει καὶ δυνάμει
 τοὺς ἐπαγομένους πολίτας τῶν ξένων· εἰ δὲ μή,
 3 ἐπ' ἐκείνοις γίνονται αὐτοὶ τε καὶ ἡ πόλις. οἷον
 Χαλκηδονίοις πολιορκουμένοις παρόντες σύμμαχοι
 . . .⁵ ἔπεμψαν φρουρὰν αὐτοῖς οἱ τῶν Χαλκη-
 δονίων⁶ σύμμαχοι. βουλευομένων τὰ αὐτοῖς⁷
 συμφέροντα οὐκ ἔφασαν⁸ οἱ φρουροὶ ἐπιτρέψειν,
 εἰ μὴ καὶ Κυζικηνοῖς δοκῆ⁹ εἶναι συμφέροντα,
 ὥστε τοῖς Χαλκηδονίοις¹⁰ τὴν φρουρὰν ἔσω οὖσαν¹¹

¹ Added by Casaubon.

² Meineke : γινομένης M.

³ Hercher : αὐτοῖς M.

⁴ Casaubon indicated the lacuna : Reiske suggested ἐπηγ-
 μένων, which is followed in the translation.

⁵ Sauppe indicated the lacuna : R. Schöne suggests that
 an expression like κίνδυνον παρεσκεύασαν and some mention
 of the Cyzicenes have fallen out.

⁶ καλχιδονίων M.

⁷ Köchly and Rüstow : αὐτοῖς M.

with cupping-glasses, and made cuts on their bodies and ran out bleeding into the market-place, as though they had been wounded. At the same time the other soldiers, who had been prepared for this, speedily took up their arms, and with them the Corcyreans who were in the conspiracy; and while the others had no notion of what was happening, and had, indeed, been summoned to an assembly, the leaders of the people's party were seized, as if they had been the ones who made the uprising. The rest of the affair, also, the conspirators arranged to their own advantage.

XII. [*Precautions with regard to allied Forces*]

If allied forces [are admitted] into the city they should never be stationed together, but should be separated in the manner already suggested and for the same reasons. In the same way those who are to make use of mercenary troops should always have citizens under arms surpassing these mercenaries in number and power, otherwise both the citizens and the state are at their mercy. [A danger] of this sort [befell] the Chalcedonians¹ while in a state of siege, due to the presence of allied forces sent by [the people of Cyzicus], their allies. When the Chalcedonians were deliberating upon measures affecting their interest, the troops of the garrison said that they would not consent unless it seemed advantageous to the people of Cyzicus as well, so that the garrison within the walls was much more

¹ Nothing further is known about this event.

⁸ Casaubon: ἐφησαν M.

¹⁰ καλχιδονίσις M.

⁹ Casaubon: δοκεῖ M.

¹¹ Casaubon: ἐσω ὄρων M.

AENEAS TACTICUS

πολύ φοβερωτέραν εἶναι τῶν προκαθημένων πο-
 4 λεμίων. δεῖ οὖν μήποτε εἰς πόλιν οἰκίαν μείζω
 δύναμιν ἐπακτὸν¹ δέχεσθαι τῆς ὑπαρχούσης τοῖς
 πολίταις, ξένοις τε χρωμένην² ἀεὶ δεῖ τὴν πόλιν
 πολλῶ ὑπερέχειν τῆς τῶν ξένων δυνάμεως· οὐ
 γὰρ ἀσφαλὲς ξενοκρατεῖσθαι καὶ ἐπὶ³ μισθο-
 5 φόροις γίνεσθαι. οἷον καὶ Ἡρακλεώταις τοῖς
 ἐν τῷ Πόντῳ συνέβη. ἐπαγόμενοι γὰρ ξένους
 πλείονας τοῦ προσήκοντος, πρῶτον μὲν τοὺς
 ἀντιστασιώτας ἀνεῖλον, ἔπειτα αὐτοὺς⁴ καὶ τὴν
 πόλιν ἀπώλεσαν, τυραννευθέντες ὑπὸ τοῦ εἰσ-
 άγοντος τοὺς ξένους.

XIII. [Ξενοτροφία⁵]

Ἄν δὲ δέη ξενοτροφεῖν, ὡδε ἂν ἀσφαλέστατα⁶
 γίγνοιτο. χρὴ τοῖς ἐν τῇ πόλει εὐπορωτάτοις
 προστάξαι κατὰ δύναμιν ἐκάστῳ παρασχεῖν ξένους
 ἕκαστον, τοὺς μὲν τρεῖς, τοὺς δὲ δύο, τινὰς δὲ
 ἓνα· ἀθροισθέντων δὲ ὅσων ἂν δέοιο,⁷ διελεῖν
 2 αὐτοὺς⁸ εἰς λόχους, καταστήσαντας ἐπ' αὐτοὺς
 τῶν πολιτῶν τοὺς πιστοτάτους λοχαγούς. τὸν
 δὲ μισθὸν καὶ τὴν τροφήν οἱ ξένοι παρὰ τῶν
 μισθωσαμένων λαμβανόντων, τὸ μὲν τι παρ'
 3 αὐτῶν, τὸ δὲ καὶ τῆς πόλεως συμβαλλομένης.
 καὶ διαιτάσθωσαν ἕκαστοι ἐν ταῖς τῶν μισθω-
 σαμένων οἰκίαις, οἱ δὲ τὰς λειτουργίας καὶ τὰς

¹ Casaubon: ἐπ' αὐτὸν M.

² Köchly and Rüstow: χρώμενον M.

³ Casaubon: ἔτι M. ⁴ R. Schöne: αὐτοὺς M.

⁵ In M this word follows the next sentence.

⁶ Hercher: ἀσφαλέστατοι M. ⁷ R. Schöne: ὅσων δέοιτο M.

⁸ C(?) , Casaubon: ἑαυτοὺς M.

¹ This is clearly a reference to the career of Clearchus, a
 72

terrible to the Chalcedonians than was the besieging enemy. One must, therefore, never admit into a city an alien force greater than that already available to the citizens, and the state employing mercenaries must always be much superior to them in strength, since it is not safe to be outnumbered by aliens nor to be in the power of mercenaries, as actually happened to the inhabitants of Heracleia Pontica; for, by bringing in more hired troops than they should, they first made away with those of the opposing faction, but later brought destruction to themselves and the state, being forced into subjection to the man who introduced the mercenaries.¹

XIII. [*Maintenance of Mercenaries*]

If, however, it is necessary to maintain mercenaries it may be most safely done as follows. The wealthiest citizens should be required to provide mercenaries, each according to his means, some three, some two, others one. When as many as you need are assembled, they should be divided into companies, and the most trustworthy of the citizens placed over them as captains. Pay and maintenance the mercenaries should receive from their employers, partly at the private expense of the latter, partly from funds contributed by the state. And each group of them should board in the houses of their employers, but they should be

former pupil of Plato and Isocrates, who entered the city with a force of mercenaries in 364-3 (Diodorus xv. 81. 5) and ruled for twelve years. His régime was marked by much violence, not all due to his fault, and he enjoys the distinction of being the first prince of whom it is recorded that he founded a library. See Ed. Meyer, *Gesch. d. Alt.* v. § 980.

AENEAS TACTICUS

ἐκκοιτίας καὶ τὰ ἄλλα ἐπιτάγματα ἐκ τῶν ἀρχόντων ἀθροιζόμενοι ὑπὸ τῶν λοχαγῶν ὑπηρετούντων.
4 κομιδῇ δὲ τοῖς προαναλίσκουσιν εἰς τοὺς ξένους χρόνῳ τινὶ γενέσθω ὑπολογιζομένων¹ τῶν εἰς τὴν πόλιν εἰσφερομένων παρὰ ἐκάστου τελῶν· οὕτω γὰρ ἂν τάχιστά τε καὶ ἀσφαλέστατα καὶ εὐτελέστατα ξενοτροφηθείη.

XIV. [Ἑπόδειξις εἰς ὁμόνοιαν²]

Τοῖς μὲν οὖν ἐν τῇ πόλει ὑπεναντία θέλουσιν τοῖς καθεστηκόσι προσφέρεσθαι ὡς προγέγραπται. τὸ δὲ πλῆθος τῶν πολιτῶν εἰς ὁμόνοιαν τέως μάλιστα χρῆ προάγειν, ἄλλοις τε ὑπαγόμενον αὐτοὺς καὶ τοὺς χρεωφειλέτας³ κουφίζοντα τόκων βραχύτητι ἢ ὄλως ἀφαιροῦντα, ἐν δὲ τοῖς λίαν ἐπικινδύνοις καὶ τῶν ὀφειλημάτων τι μέρος, καὶ πάντα ὅταν δέη,⁴ ὡς πολὺ γε φοβερώτατοι ἔφεδροί εἰσιν οἱ τοιοῦδε ἄνθρωποι, τοὺς τε ἐν ἀπορίᾳ ὄντας
2 τῶν ἀναγκαίων εἰς εὐπορίαν καθιστάναι. καὶ ὅπως ἴσως καὶ ἀλύπως τοῖς πλουσίοις ταῦτ' ἂν⁵ γιγνόμενα πράττοιτο καὶ ἐξ οἴων πόρων⁶ πορίζοιτο, καὶ περὶ τούτων ἐν τῇ Ποριστικῇ βίβλῳ δηλωτικῶς γέγραπται.

XV.

Κατασκευασθέντων δὲ τούτων, ἂν τι ἀγγελθῆ⁷ ἢ πυρσευθῆ βοηθείας δεόμενον, ἐξιέναι ἐπὶ τὰ

¹ Haase : ὑπολογιζομένοις ὑπὸ Μ.

² In M these words follow the next sentence.

³ Casaubon : χρεωφειλέτας Μ. ⁴ Haase : ὅτ' ἂν δὲ Μ.

assembled by their captains for the performance of public services, night watches, and other tasks assigned by the authorities. Reimbursement should be made in due time to those who have incurred expense for the mercenaries, after deducting the taxes due the state from each individual. For in this way maintenance may be provided for mercenaries most quickly, safely, and cheaply.

XIV. [*Suggestions for securing Loyalty*]

With those, then, in the city who are opposed to the existing order one may deal in the manner already prescribed. In the meantime it is of primary importance to win over the mass of the citizens to a spirit of loyalty, both by other influences and in the case of the debtors by the reduction or complete cancellation of interest, and, in cases of especial danger, of some part of the principal, or even all of it when necessary; for such men as these are the most formidable of adversaries. Adequate provision must also be made for those who are in want of the necessities of life. How these measures may be taken fairly and without offence to the wealthy, and from what revenues the expenses may be met, has also been clearly explained in the book on *Finance*.¹

XV.

After the foregoing matters have been arranged, if a call for help come, either by messenger or by signal-fire, troops must be sent out to the parts of

¹ See Introd. p. 8.

⁵ Hertlein: ταῦτα M.

⁶ Casaubon: πόνων M.

⁷ Casaubon: ἀγγελθέν M (ἀγγελθέν ἦ Oldfather).

AENEAS TACTICUS

2 κακούμενα τῆς χώρας. τοὺς δὲ στρατηγοὺς τοὺς¹ παρόντας εὐθύς συντάττειν,² ἵνα μὴ σποράδην καὶ κατ' ὀλίγους ἐξιώντες ἐπὶ τὰ αὐτῶν³ ἀπολλύωνται⁴ δι' ἀταξίαν καὶ κόπον ἄκαιρον, ἐνεδρευόμενοι τε ὑπὸ τῶν πολεμίων καὶ κακὰ πάσχοντες.

3 ἀλλὰ χρή τοὺς τε παραγιγνομένους ἐπὶ τὰς πύλας ἀθροίζεσθαι μέχρι τινὸς πλήθους, ὡς λόχου⁵ ἢ διλοχίας, εἶτα συνταχθέντας καὶ ἡγεμόνος αὐτοῖς φρονίμου δοθέντος, οὕτως ἐκπέμπεσθαι καὶ σπεύ-
4 δειν ἰόντας⁶ ἐν τάξει ὡς μάλιστα. ἔπειτα ἄλλο καὶ⁷ ἄλλο πλήθος⁸ οὕτως ἐκπέμπειν καὶ ἐν τάχει μέχρις οὗ ἱκανοὶ δοκοῦσιν ἐκβεβοηθηκέναι, ἵνα καὶ ἐν τῇ πορείᾳ ἐχόμενα ἢ τὰ μέρη, καὶ ἐάν τε⁹ μέρει¹⁰ μέρος δέη βοηθῆσαι ἐάν τε ἅμα πάντα δέη, ραδίως ὑπάρχη¹¹ συμμίσγειν ἀλλήλοις καὶ
5 μὴ δρόμῳ πόρρωθεν παραγίγνωνται.¹² πρὸ δὲ αὐτῶν δεῖ πρώτους τοὺς ὑπάρχοντας ἰππέας καὶ κούφους ἐξίεναι, μηδὲ τούτους ἀτάκτους,¹³ προεξερευνῶντάς τε καὶ προκαταλαμβάνοντας τὰ ὑψηλὰ τῶν χωρίων, ἵν' ὡς ἐκ πλείστου προειδῶσιν οἱ ὀπλίται¹⁴ τὰ τῶν πολεμίων καὶ μηδὲν ἐξαίφνης
6 αὐτοῖς προσπέση.¹⁵ περὶ τε τὰς καμπὰς τῶν χωρίων καὶ τὰς βάσεις τῶν ἀκρολοφίων καὶ τὰς ἐκτροπὰς τῶν ὁδῶν, ὅπου ἂν τρίοδοι ᾖσιν, εἶναι σημεῖα, ἵνα μὴ περὶ ταῦτα σχίζωνται ἀπ' ἀλλήλων
7 οἱ ὑπολελειμμένοι δι' ἄγνοιαν τῆς ὁδοῦ. ἀπιόντα¹⁶

¹ Added by Hercher.

² Casaubon: συντάττει M.

³ Hertlein: αὐτῶν M.

⁴ Casaubon: ἀπολλύονται M.

⁵ Casaubon: λόχω M.

⁶ Reiske: δυνασ M.

⁷ Meineke: καὶ κατὰ M.

⁸ Casaubon: πάθος M.

⁹ Casaubon: τὰ M.

¹⁰ Reiske: μέρος M.

¹¹ Casaubon: ὑπάρχειν M.

¹² Casaubon: παραγίγνωνται M.

¹³ Suggested by R. Schöne.

ÆNEAS THE TACTICIAN, xv. 1-7

the country that are being devastated. The generals must immediately marshal such men as are at hand, in order that they may not go forth in small and scattered groups, each bent upon saving his own property, and ruin themselves from lack of discipline and premature exertion, meeting disaster through ambuscades of the enemy. Those who report for duty must assemble, up to a certain number, at the gates, for instance, the quota of one or two companies, and only after they have been marshalled and a capable leader has been assigned them must they be dispatched from the town, and then they must hasten as fast as military order will allow. Then other groups in succession must be speedily dispatched in the same fashion until enough seem to have been sent forth to render the assistance needed. This must be done in order that the divisions may be close together on the march, and, if it is necessary for one division to assist another, or for all to act together, they may easily be united and those in the rear may not have to come from a distance on the run. The available cavalry and light-armed troops, however, also in good order, should go ahead of the others and should reconnoitre and preoccupy the elevated positions, that the heavy-armed troops may be aware as early as possible of the movements of the enemy and may not be surprised by any sudden attack. At places where there are turning-points, bases of the ridges, and forks in the roads, that is, wherever there are diverging ways, signs should be placed, lest at these points the stragglers, through ignorance of the road, be separated from their fellows.

¹⁴ Köchly and Rustow : *πολίται* M.

¹⁵ Reiske : *προσπέσοι* M.

¹⁶ Hertlein : *ἀπιόντας* M.

AENEAS TACTICUS

- τε εἰς τὴν πόλιν πεφυλαγμένως ἀναχωρεῖν πολλῶν ἔνεκεν καὶ μάλιστα ἐνέδρας φοβούμενον πολεμίων· ἤδη γὰρ περὶ βοήθειαν ἀφύλακτον τοιόνδε συνέβη.
- 8 Τριβαλλῶν ἐμβαλλόντων εἰς τὴν Ἀβδηριτῶν χώραν, ἐπεξελθόντες Ἀβδηρίται καὶ παράταξιν ποιησάμενοι κάλλιστον ἔργον εἰργάσαντο· συμβαλόντες γὰρ κατέβαλον πολλοὺς καὶ ἐνίκων
- 9 πλῆθος πολὺ καὶ μάχιμον. οἱ δὲ Τριβαλλοί, ἀγανακτήσαντες τῷ συμβάντι, ἀπαλλαγέντες καὶ ἀναλαβόντες αὐτούς,¹ πάλιν ἀφικόμενοι εἰς τὴν χώραν καὶ ἐνέδρας προκαθίσαντες ἔκειρον τὴν χώραν τὴν Ἀβδηριτῶν οὐ πόρρω τῆς πόλεως, οἱ δὲ Ἀβδηρίται ὑπερφρονήσαντες αὐτῶν διὰ τὸ προειργασμένον ἔργον ἐπεβοήθουν πανσυδίῃ πάσῃ ῥώμῃ καὶ προθυμίᾳ· οἱ δὲ ὑπήγον αὐτοὺς εἰς τὰς
- 10 ἐνέδρας. ὅπου δὴ² λέγεται ἐκ μιᾶς πόλεως, τοσαύτης γε τὸ μέγεθος, πλείστους ἐν ἐλαχίστῳ χρόνῳ ἀπολέσθαι. οὐδὲ γὰρ ἀκούσαντες τὸν ὄλεθρον τῶν πρώτων ἐπεξελθόντων οἱ ἄλλοι ἐπέσχον τῆς βοήθειας, ἀλλ' ἄλλος ἄλλον παρακαλῶν ἔσπευδεν βοηθεῖν τοῖς ἐπεξελθοῦσι, μέχρι ἡρημώθη ἡ πόλις ἀνδρῶν.

XVI. [Ἄλλη βοήθεια]

- Ἄλλος ὄν³ ἄλλος τρόπος βοήθειας βελτίων ἂν εἴη
 2 ἐπὶ τοὺς ἐμβεβληκότας. πρῶτον μὲν οὖν νυκτὸς⁴

¹ Hercher : αὐτοὺς M.

² Casaubon : δὲ M.

³ Hug : ὄδ' (i. e. ὁ δ')

⁴ Added by R. Schöne.

¹ Diodorus xv. 36. 1 ff. sets this occurrence in 376-5 B.C., but ascribes the disaster mainly to the treachery of a force

Likewise when the bands return to the city they should employ caution, for many reasons, but chiefly for fear of the enemy's ambuscades. For this sort of thing has been known to happen to incautious relief parties. When the Triballi were invading the country of the Abderites,¹ the latter sallied forth against them, formed in battle array, and carried out a brilliant operation; for joining battle they killed many and defeated a large and powerful force. Now the Triballi, enraged at the occurrence, withdrew and reorganized, and making another inroad into the country set ambuscades and started to lay waste the land of the Abderites not far from the city. The Abderites held them in contempt because of the previous achievement and made a hasty attack against them with great force and eagerness, but the Triballi drew them into their ambuscades. On that particular occasion it is said that more men perished in a shorter time than had ever been the case, at least from a single city of similar size. For the others, not having learned of the destruction of those who had gone out first, did not pause in their rush to the rescue, but cheering one another on, hurried away to render assistance to those who had already sallied forth, until the city was bereft of men.

XVI. [*Other Kinds of Relief*]

Still another kind of relief would be more effective against the invaders. In the first place one should of Thracians who turned upon the Abderites in the course of the battle.

AENEAS TACTICUS

οὐ χρὴ εὐθύς¹ βοηθεῖν, εἰδότα ὅτι ἀτακτότατοι ἂν
καὶ ἀπαρασκευοὶ πρὸ τῆς ἔω² εἶεν οἱ ἄνθρωποι,
τῶν μὲν ἐπείγομένων τὰ οἰκεία σώζειν ὡς τάχιστα
ἐκ τῶν ἀγρῶν, ἑτέρων δὲ πεφοβημένων εἰς τοὺς
κινδύνους προίεσαι, οἷα³ εἰκὸς προσφάτως ἀγγελ-
μένων,⁴ ἄλλων δὲ πάμπαν ἀπαρασκευῶν ὄντων.
3 χρὴ οὖν τὴν μὲν βοήθειαν εὐτρεπίζειν ἀθροίζοντα ὅτι
τάχος, ἅμα τῶν μὲν τὸ δεῖμα ἀφαιροῦντα, τοῖς δὲ
4 θάρσος ἐμποιοῦντα⁵ τοὺς δὲ ὀπλίζοντα.⁶ δεῖ γάρ
σε εἰδέναι ὅτι τῶν πολεμίων οἱ μετὰ ξυνέσεως καὶ
ἐπιστήμης γιγνόμενοι ἐν πολεμίᾳ,⁷ κατ' ἀρχὰς μὲν
τὸ ἰσχυρότατον αὐτῶν⁸ ἐν τάξει ἄγουσι προσδεχό-
μενοί τινες ἐφ' ἑαυτοὺς ἰέναι⁹ καὶ ἐτοιμῶς ἔχοντες
ἀμύνεσθαι· τινὲς δὲ διασπαρέντες αὐτῶν κατὰ τὴν
χώραν ἀδικοῦσιν, ἄλλοι δ' ἂν ἐνεδρεύοιεν προσδεχό-
μενοί τινες βοηθοῦντας ὑμῶν¹⁰ ἄτακτον βοήθησιν.
5 δεῖ οὖν μὴ εὐθύς αὐτοὺς προσκείμενον ἐνοχλεῖν, ἀλλ'
ἐᾶσαι τούτους πρότερον θαρσῆσαι καὶ καταφρονή-
σαντάς σου ἐπὶ λεηλάτησιν καὶ πλεονεξίαν ὀρμῆσαι·
ἅμα δ' ἂν οὗτοι σιτίων καὶ πόσεως πληρούμενοι καὶ
οἰνωθέντες ἀμελεῖς¹¹ καὶ ἀπειθεῖς τοῖς ἄρχουσι
6 γίγνοιτο. ἐκ δὲ τούτων εἰκὸς μοχθηροὺς αὐτῶν
τοὺς ἀγῶνας καὶ τὴν ἀποχώρησιν συμβαίνειν,
7 ἐάνπερ γε σὺ αὐτοῖς εὐκαίρως ἐπιθῆ.¹² ἤτοιμα-
σμένης γάρ σοι τῆς βοηθείας εἰς τὸν παρηγγελμένον
τόπον καὶ ἐσπαρμένων ἤδη τῶν πολεμίων πρὸς
ἀρπαγὴν, οὕτω χρὴ αὐτοῖς προσκείσθαι τοῖς μὲν

¹ Hercher : εὐθὺ Μ.

² προθέσεως Wunsch (accepted by Behrendt and Fischer).

³ Casaubon : οἱ δ' Μ.

⁴ Defended by Behrendt from usage of Herodotus :
ἠγγελημένων Casaubon.

⁵ Casaubon : ἐμποιοῦντας Μ.

AENEAS THE TACTICIAN, XVI. 2 - 7

not in the night-time go straight out to give assistance, seeing that before dawn the inhabitants would be in very great disorder and also unprepared, some hurrying with all speed to save their property on the farms, others dreading to face danger, as is natural when the alarm is sudden, while still others are wholly unready. It is necessary, therefore, to assemble and prepare the rescue force with all speed, at the same time freeing some from their fear, inspiring others with confidence, and arming still others. For you must know that when an enemy goes to war with judgement and understanding, he at first advances the strongest of his forces in military order, expecting a counter-attack and ready to defend himself. Meanwhile a part of these invaders separate and devastate the country, while others would lie in ambush expecting some of your forces to come in disorder to lend assistance. It is not best, therefore, to disturb them by an immediate attack, but to allow them first to become bold, and in their contempt of you to start off pillaging and satisfying their greed. At the same time these men when sated with food and drink and heavy with wine would become careless and disobedient to their leaders; and as a result of this they will be likely to put up a poor fight, and will retreat, at least if you fall upon them opportunely. For, when your supporting force is ready at the appointed place, and the enemy has already scattered for plunder, then and then only you should

⁶ Casaubon: ὀπλιζοντας M.

⁸ Hercher: αὐτῶν M.

¹⁰ Casaubon: ἡμῶν M.

⁷ Casaubon: ἐν πόλει μιά M.

⁹ Added by R. Schöne.

¹¹ Casaubon: ἀμελλεῖς M.

¹² Hause: ἐπιθήσῃ M.

AENEAS TACTICUS

ἵππεύσιν προκαταλαμβάνοντα τὰς ἀποχωρήσεις, τοῖς δ' ἐπιλέκτοις ἐνέδρας ποιούμενον, τοῖς δ' ἄλλοις κούφοις¹ ἐπιφαινόμενον αὐτοῖς, τοὺς δ' ὀπλίτας ἀθρόους ἐν τάξει ἄγοντα,² μὴ πόρρω δὲ τῶν προπεμφθέντων³ μερῶν.

Ἐπιτίθεσο δὲ τοῖς πολεμίοις ἐν οἷς ἄκων μὲν μὴ⁴ μαχήσῃ, μαχόμενος δὲ μὴ ἔλασσον ἔξεις τῶν πολεμίων. διὰ οὖν τὰ πρότερα⁵ εἰρημένα λυσιτελεῖ ποτε ἐφεῖναι καὶ ἐᾶσαι τοὺς πολεμίους ὡς πλείστην κατασύραι τῆς χώρας, ἵνα δὴ⁶ λεηλατοῦντες καὶ διαπεπληρωμένοι λαφύρων ῥαδίως σοι τὴν δίκην δώσουσιν· τὰ τε γὰρ ληφθέντα πάντ' ἂν⁷ σώζοιτο,⁸ οἳ τ' ἀδικήσαντες κατ' ἀξίαν λάβοιεν τὰ ἐπιτίμια. ὁξέως δ' ἂν βοηθήσας τοῖς μὲν σαυτοῦ ἀπαρασκευοῖς τε καὶ οὐ⁹ τεταγμένοις κινδυνεύοις, οἳ τε πολέμοι μικρὰ μὲν ἂν φθάσαιεν κακουργήσαντες, ἐν τάξει δ'¹⁰ ἂν ἔτι ὄντες ἀτιμώρητοι ἂν ἀπέλθοιεν. πολὺ δὲ κρείσσον, ὡς γέγραπται, ἐνδόντα ἀφυλάκτως διακειμένοις αὐτοῖς ἐπιθέσθαι. εἰάν δέ σε λάθῃ ἢ φθάσῃ τὰ ἐκ τῆς χώρας λεηλατηθέντα, οὐ χρὴ τὴν δίωξιν αὐτῶν ποιεῖσθαι τὰς αὐτὰς ὁδοὺς καὶ τοὺς αὐτοὺς χώρους, ἀλλὰ τῆδε¹⁰ μὲν ὀλίγους ἐπιφαίνεσθαι καὶ διώκοντας μὴ ἐπικαταλαμβάνειν ἔκουσίως καὶ ἀνυπόπτως, ἄλλο δὲ πλῆθος μετὰ ἀξιοχρέου δυνάμειως σπεύδειν κατ' ἄλλας ὁδοὺς ὅτι τάχιστα πορευόμενον, καὶ φθάσαντας¹¹ ἐν τῇ τῶν ἀγόντων

¹ Casaubon : κούφως M.

² Casaubon : ἄγοντας M.

³ Casaubon : προοφθέντων M.

⁴ Added by Casaubon.

⁵ πρότερον Casaubon.

⁶ Reiske : ἢ M.

⁷ Hertlein : πάντα M.

⁸ Orelli : σώζοιτο M.

⁹ Added by Casaubon.

¹⁰ Casaubon : τῆσδε M.

attack them, cut off their retreat with your cavalry, set ambuscades of picked men, and, engaging them with your other light-armed forces, bring up your heavy-armed troops in close formation not far behind the divisions already sent forward.

Attack the enemy where you are not unwilling to do battle, and where you will not be at a disadvantage in the fight. Hence, for the reasons already stated, it is sometimes to your interest to give the enemy rein, and to allow him to lay waste as much of the land as he wishes, where, while plundering and laden with spoil, he will easily suffer punishment at your hands. For in this way all that has been taken would be recovered, and those who had done the damage would receive their just deserts. On the other hand, if you should hastily send out relief forces, you might endanger your own men, unprepared and not yet in order, while the enemy, although they would already have done a little harm, yet, because they were still in order, would get away unpunished. But it is much better, as I have written,¹ to give way to them, and then attack them when off their guard. But if the plundering of the country has escaped your notice or has occurred before you could prevent it, you should not make your pursuit of the enemy along the same roads nor in the same places, but should cause only a few to make a demonstration there, and, in their pursuit, intentionally but without arousing suspicion, refrain from overtaking them, while the army as a whole, in considerable strength, should hasten as quickly as possible by other roads, and,

¹ The reference is to §§ 5, 6, and 7 of this same chapter.

¹¹ Haase : *φθόσωντος* M.

AENEAS TACTICUS

- 12 χώρα περι τὰ ὄρια ἐνεδρεῦσαι (φθάσαι δέ σε εἰκός ἐστι, πρότερον εἰς τὴν ἐκείνων ἀφικόμενον, διὰ τὸ λείαν¹ ἄγοντας αὐτοὺς βραδυτέρως πορεύεσθαι), τὴν δ' ἐπίθεσιν αὐτοῖς ποιεῖσθαι δειπνοποιουμένοις· οἱ γὰρ λεηλατήσαντες, ἔν τε τῇ αὐτῶν² ἤδη γεγονότες καὶ ἐν ἀσφαλεῖ ὄντες, πρὸς ῥαθυμίαν τρε-
- 13 πόμενοι ἀφυλακτοτέρως ἂν διακείοντο. ἄριστον δ'³ ἵνα νεοκμησῶν⁴ τοῖς στρατιώταις χρήσῃ, ὑπαρχόντων γε⁵ πλοίων, κατὰ θάλατταν τὴν δίωξιν ποιεῖσθαι· τό τε γὰρ φθάσαι καὶ τὰ ἄλλα εἰς τὸ δέον σοι συμβήσεται, ἐὰν μὴ κατοφθῆς πλέων ὑπ' αὐτῶν. Κυρηναίους δέ⁶ καὶ Βαρκαίους λέγεται καὶ ἄλλας τινὰς πόλεις τὰς ἀμαξηλάτους τε ὁδοὺς καὶ μακρὰς βοηθείας ἐπὶ συνωρίδων καὶ ζευγῶν βοηθεῖν· κομισθέντων δὲ εἰς τὸ προσήκον καὶ ἐξῆς τῶν ζευγέων παραταχθέντων, ἀποβάντες οἱ ὀπλίται καὶ ἐν τάξει γενόμενοι εὐθὺς νεοκμηῆτες προσ-
- 15 εφέροντο τοῖς πολεμίοις. οἷς οὖν εὐπορία ζευγῶν, καλὸν τὸ πλεονέκτημα, ταχύ τε καὶ νεοκμηῆτας τοὺς στρατιώτας εἰς τὸ δέον ἐλθεῖν· εἶψαν δὲ ἂν αἱ ἄμαξαι εὐθὺς καὶ ἔρυμα ταῖς στρατοπεδείαις· οἱ τραυματῖαι καὶ εἴ τι ἄλλο γένοιτο σύμπτωμα τοῖς στρατιώταις, ἐπὶ τούτοις ἀπάγουντ' ἂν εἰς τὴν πόλιν.
- 16 Καὶ ἐὰν μὲν ἦ ἡ χώρα μὴ εὐεῖσβολος, ἀλλ' ὀλίγα ὤσων αἱ εἰσβολαὶ καὶ στεναί, προκατασκευάσαντας⁷

¹ Casaubon : λῖαν M.

² Hercher : αὐτῶν M.

³ Added by Casaubon.

⁴ Casaubon : ἱναεομησῶσιν M.

⁵ Casaubon : δὲ M.

⁶ Casaubon : κρηναίους καὶ M.

⁷ Köchly and Rüstow : προκατασκευάσαντα M.

¹ This region was widely celebrated for its horses and cars, and according to one account the Libyans were the first to yoke horses to a chariot, a tradition which would

AENEAS THE TACTICIAN, xvi. 11 - 16

anticipating the enemy, should lie in ambush in the land of the invaders, near the border. You may reasonably expect to reach their land first, since because of driving their booty they must advance more slowly. And you should make your attack upon them while they are at the evening meal; for when the marauders are already within their own border and feel themselves secure they would be inclined to carelessness and be more off their guard. The best plan of all, however, in order to have your soldiers fresh for battle, provided boats are at hand, is to make the pursuit by sea; for you will thus outstrip the enemy, and the other conditions necessary for success will favour you, provided you are not detected by them on your voyage. Of the people of Cyrene and Barca and certain other cities the story runs that they made their rescue expeditions over long wagon-roads in four- and in two-horse vehicles;¹ and when they had reached the appointed place, and the vehicles had been arranged in order, the heavy-armed troops alighted, and, forming at once in ranks, attacked the enemy with unimpaired strength. Hence, for those who have a ready supply of vehicles, it is a great advantage to have their soldiers arrive quickly where they are needed and with fresh strength; further, the wagons would be a ready defence for the camp, while soldiers who were wounded or suffering from any other mishap could be conveyed in them back to the city.

And if the country be not easy to invade but have few and narrow approaches, you should prepare

be very natural if the suggestion that Libya was the original home of the ancestors of the thorough-bred horse be correct.

AENEAS TACTICUS

- αὐτάς,¹ ὡς προέγραπται οὕτω μερισθέντας,² ἐπὶ ταῖς εἰσβολαῖς³ ἐναντιοῦσθαι τοῖς ἐπιχειροῦσι καὶ βουλομένοις πρὸς τὴν πόλιν προσιέναι, προδιαταξαμένους⁴ καὶ τοὺς⁵ φρυκτοῖς γνωρίζοντας τὰ ἀλλήλων πάθη, ὅπως τὰ μέρη βοηθῆ, ἂν τι δέωνται ἀλλήλων.
- 17 ἂν δὲ μὴ δυσείσβολος ἦ ἡ χώρα, ἦ δὲ⁶ πολλαχῆ πολλοὺς εἰσβάλλειν, χρησίμους⁷ καταλαβεῖν τῆς χώρας τόπους, ὥστε τοῖς πολεμίους χαλεπὴν εἶναι
- 18 τὴν πάροδον ἐπὶ τὴν πόλιν. ἂν δὲ μηδὲ ταῦτα ὑπάρχη, τῶν λοιπῶν καταλαβεῖν ἐγγὺς τῆς πόλεως χωρία σύμμαχα πρὸς τὸ μάχεσθαι τε⁸ πλεονεκτικῶς καὶ εὐαπαλλάκτως ἔχειν τοῦ χωρίου⁹ ὅταν βούλη¹⁰ ἀπιέναι πρὸς τὴν πόλιν· κἂν¹¹ οὕτως ἐμβαλόντες οἱ πολέμοι εἰς τὴν χώραν πρὸς τὴν πόλιν πορεύωνται, κατάρχειν¹² ὑμᾶς τῆς μάχης ἐκ τῶν χωρίων τούτων
- 19 ὀρμωμένους. τὰς δ' ἐπιθέσεις αὐτοῖς ποιεῖσθαι αἰεὶ πλεονεκτοῦντα ἐκ τῆς χώρας τῇ συνηθείᾳ· πολὺ γὰρ προέξεις¹³ προειδῶς τὰ χωρία καὶ προάγων εἰς τόπους οἴους ἂν σὺ βούλη,¹⁴ σοὶ μὲν γνωστοὺς¹⁵ καὶ ἐπιτηδείους καὶ φυλάξασθαι καὶ διώξαι καὶ φυγεῖν καὶ ἀπιέναι εἰς τὴν πόλιν λαθραίως καὶ φανερώς— ἔτι δὲ καὶ τὰ ἐπιτήδεια προειδῶτα ὅπου ἂν τῆς χώρας ὑπάρχη ὑμῶν —, τοῖς δὲ πολεμίους ἀσυνήθεις¹⁶ καὶ ἀγνώτας καὶ λελειμμένους πάντων τούτων.

¹ Orelli: αὐτὰ M: αὐταῖς Capps.

² Casaubon: μερισθέντα M: μέρη μερισθέντα Capps.

³ Köchly and Rüstow; τῆς εἰσβολῆς M.

⁴ Casaubon: προδιαταξαμένους M.

⁵ Added by Hercher. ⁶ Hertlein: ἤδη M.

⁷ Herm. Schöne: χρῆ ὑμᾶς M.

⁸ Casaubon: τι M.

⁹ Herm. Schöne: ἔχων τὸ χωρίον M.

¹⁰ Hertlein: ὅτ' ἂν βούλει M.

¹¹ Herm. Schöne: καὶ M.

these in advance by such a distribution of forces as has just been described, placing soldiers at the approaches to oppose those who are attacking and wish to march upon the city, having stationed in advance other troops who are made aware by signal-fires of the fortunes of the several divisions, in order that these may bring support, if in any way they need one another's help. If, on the other hand, the land is not difficult to invade, but it is possible for large forces to attack at many points, the strategic positions of the country should be seized, so that the approach to the city may be difficult for the enemy. Again, if such places do not exist, it is necessary to occupy near the city other points of support, so that you may both fight to good advantage and also be able easily to withdraw from the place whenever you wish to retreat to the city. And then if the enemy break into the country and make for the city, you must begin the fighting, setting out from these places. You must always, in making your attacks upon the enemy, strive to profit from your acquaintance with the terrain; for you will have a great advantage from previous knowledge of the country and by leading the enemy into such places as you may wish, which are known to you and suitable, whether for defence, or pursuit, or flight, or withdrawal into the city either secretly or openly. Moreover, you will also know in advance what part of the country will supply you with provisions, whereas the enemy will be unacquainted, ignorant, and embarrassed in all these particulars.

¹² Herm. Schöne: πορεύονται και αρχειν M.

¹³ Reiske: προήξεις M.

¹⁴ Hertlein: βούλει M.

¹⁵ Casaubon: γνωτούς M.

¹⁶ Casaubon: συνήθεις M.

AENEAS TACTICUS

- 20 εἰδότες δὲ¹ ὅτι ἄπειρον ὄντα τῆς χώρας οὐ μόνον ἀδύνατον πράξαι τι ὧν θέλει, ἀλλὰ καὶ σωθῆναι χαλεπόν, τῶν γε ἐν τῇ χώρᾳ βουλομένων ἐπιχειρεῖν, πρὸς πάντ' ἂν² ἀτόλμως καὶ δειλῶς διακείμενοι σφάλλουντο διὰ τὸ³ μηδὲν τῶν τοιούτων εἰκάζειν. διενέγκοι γὰρ ἂν ἑκατέροις⁴ ὅσον εἰ τοῖς μὲν νυκτὸς μάχεσθαι εἰλήχει⁵ τοῖς δὲ ἡμέρας, εἰ οἷόν τέ πως
- 21 ἦν⁶ τοῦτο ἅμα γενέσθαι. ὑπάρχοντος δέ σοι ναυτικοῦ, πεπληρῶσθαι τὰς ναῦς· οὐ γὰρ ἐλάσσω τοὺς πολεμίους ὀχλήσουσιν οἱ ἐν ταῖς ναυσίν, ἐάν γε⁷ παραπλέον⁸ ὑπάρχη πρὸς τὰ ἐπιθαλάσσια χωρία καὶ τὰς παρὰ θάλασσαν ὁδοὺς, ἢν' ὑπὸ ὑμῶν⁹ τε ὀχλῶνται καὶ ὑπὸ τῶν ἐκ τῶν¹⁰ νηῶν κατὰ νῶτον
- 22 αὐτοῖς τὴν ἀπόβασιν ποιουμένων. ταῦτα δὲ οὕτως πράττοντες¹¹ ἀπαρασκευαστοτάτοις ἂν τοῖς πολεμίους ἐπιθεῖσθε καὶ παρὰ δόξαν τὰ ἀφ' ὑμῶν αὐτοῖς ἀποβαίη.

XVII.

Ἐν¹² δὲ μὴ ὁμοιοῦση πόλει καὶ ὑπόπτως πρὸς ἀλλήλους ἐχόντων χρῆ πρόνοοῦντα εὐλαβεῖσθαι τὰς¹³ μετ' ὄχλου ἐξόδους ἐπὶ θεωρίαν λαμπάδος καὶ ἵπποδρομίας καὶ τῶν ἄλλων ἀγώνων ὅσαι γε

¹ Hertlein : εἰδότες ὅτι M.

² R. Schöne : πάντα ἢ M.

³ Casaubon : διότι M.

⁴ τοῖς ἐτέροις M : τοῖς deleted by Schöne : ἑκατέροις Hercher.

⁵ Herm. Schöne : νυκτὸς (space of 6 lett.) ηχη M.

⁶ Hercher : ἢ M.

⁷ Köchly and Rüstow : τε M.

⁸ Köchly and Rüstow : παραπλέον M.

⁹ Casaubon : ἡμῶν M. ¹⁰ Added by R. Schöne.

AENEAS THE TACTICIAN, XVI. 20 – XVII. 1

The enemy, moreover, knowing that if one is unfamiliar with the country, not only is he unable to accomplish anything that he wishes, but it is also difficult for him to get away in safety, at least if the inhabitants wish to attack him, would come to grief from their spiritless and timid disposition towards everything, because they are unable to conjecture anything of the sort. For there would be as great a difference between the two parties as if it were the lot of the one to fight by night and the other by day, if this could in any way happen at the same time. If you have a naval force the ships must be manned, for the marines will annoy the enemy as much as the infantry if your fleet sails by the coasts and the roads along the shore, so that the enemy will be embarrassed both by you and by the men from the ships who disembark in their rear. By your doing so the enemy would be most unprepared for your attack, and they would be surprised by the outcome of your manœuvre.

XVII.

In a city in which harmony is wanting and where the citizens are mutually distrustful, you must exercise foresight and caution about the crowds that go out to see a torch-race,¹ horse-racing, or other

¹ A characteristic form of sport among the Greeks, in which not merely speed and endurance were tested, but especially the skill with which a lighted torch could be carried a considerable distance. It was most famous at Athens, but also is attested for a number of other communities.

¹¹ Casaubon: *πράττων* M. ¹² Casaubon: *ἐάν* M.

¹³ Casaubon: *τοὺς* M.

AENEAS TACTICUS

ἱεροποιῖαι πανδημεὶ ἐκτὸς τῆς πόλεως καὶ σὺν
 ὄπλοις πομπαὶ ἐκπέμπονται, ἔτι καὶ περὶ τὰς
 πανδήμους νεωλκίας¹ καὶ τὰς συνεκφοράς τῶν
 τελευτησάντων· ἐνὶ γὰρ καὶ ἐν τοιῷδε καιρῷ
 2 σφαλῆναι τοὺς ἐτέρους.² παράδειγμα δὲ ἐξοίσω
 γενόμενον πάθος. ἑορτῆς γὰρ πανδήμου ἔξω τῆς
 πόλεως Ἀργείων γενομένης ἐξῆγον³ πομπὴν σὺν
 ὄπλοις τῶν ἐν τῇ ἡλικίᾳ· συχνοὶ δὲ τῶν ἐπιβου-
 λευόντων καὶ αὐτοὶ παρεσκευάζοντο καὶ αὐτοῖς
 3 συνείποντο ἔνοπλοι εἰς τὴν πομπήν, καὶ ὡς⁴ ἐγένετο
 πρὸς τῷ ναῷ τε καὶ τῷ βωμῷ, οἱ μὲν πολλοὶ τὰ
 ὄπλα θέμενοι ἀπωτέρω τοῦ ναοῦ πρὸς τὰς εὐχάς τε
 καὶ τὸν βωμὸν ὤρμησαν. τῶν δὲ ἐπιβουλευόντων
 οἱ μὲν ἐπὶ τῶν ὄπλων ὑπέμειναν, οἱ δὲ ταῖς ἀρχαῖς
 τε καὶ τῶν πολιτῶν τοῖς προέχουσι παρέστησαν ἐν
 4 ταῖς εὐχαῖς, ἀνὴρ ἀνδρὶ, ἔχοντες ἐγχειρίδια· καὶ
 τοὺς μὲν κατεβεβλήκεσαν,⁵ οἱ δὲ αὐτῶν εἰς τὴν
 πόλιν σὺν τοῖς ὄπλοις ἔσπευσαν. ἕτεροι δὲ τῶν
 συνεπιβουλευόντων ὑπομείναντες ἐν τῇ πόλει μετὰ
 τῶν προαλισθέντων⁶ ὀπλιτῶν⁷ προκατέλαβον οὓς
 προσῆκε τόπους τῆς πόλεως, ὥστε δέξασθαι τῶν
 ἔξω οὓς ἐβούλοντο.⁸ διὸ δεῖ⁹ τὰς τοιαύτας
 ἐπιβουλάς ἐν οὐδενὶ καιρῷ ἀφυλάκτως διακεῖσθαι.
 5 Χιοὶ δὲ ἄγοντες τὰ Διονύσια καὶ πέμποντες πομπὰς
 λαμπρὰς πρὸς τοῦ Διονύσου τὸν βωμὸν, προκατα-

¹ Casaubon: νεολκίας M.

² Casaubon: ἐταίρους M.

³ Casaubon: ἐξείργων M.

⁴ συχνοὶ (Meier) δὲ τῶν (Köchly and Rüstow) . . . παρεσκευάζοντο (Meier) . . . συνείποντο ἔνοπλοι (Hercher) . . . ὡς (added by Orelli): συχῶν τῶν δὲ κτλ. . . . παρεσκευάζον κτλ. . . . συνηττόντο ὄπλα M.

⁵ Hertlein: κατεβεβλήκεισαν M.

⁶ W. Dindorf: προαλισθέντων M. ⁷ Meineke: ὄπλων M.

⁸ Casaubon: ἐβουλεύοντο M.

⁹ Casaubon: δὴ M.

contests—whenever, that is, there are sacred rites in which the entire people engage outside the city, and processions that issue from the city under arms—; also about the public hauling up of ships and the obsequies of the dead. For it is possible on such an occasion for one faction to be overthrown, and as an example I will cite an actual instance. A public festival of the Argives¹ took place outside the city, and the citizens formed an armed procession of men of military age. Meanwhile many conspirators also got ready, equipped themselves with arms, joined the procession, and when it came to the temple and the altar the majority set down their weapons at a distance from the temple and went to pray at the altar. Of the conspirators, however, some remained with their arms, and others took their stand beside the magistrates and leading men of the city while they were at prayer, each beside his man, with dagger in hand. These men some of the conspirators struck down, while others with their arms hastened into the city, and still others of the conspirators, who had remained in the town with the hoplites who had been previously collected, captured those quarters which were necessary for their purpose, and so admitted only those whom they wished. Accordingly, against such treachery one must at no time be off his guard. The people of Chios, when they celebrate the festival of Dionysus and send brilliant processions to his altar, first with

¹ This was on the occasion of the short-lived oligarchic revolution after the battle of Mantinea in 418 B.C. The "hoplites who had been previously collected," of whom Aeneas speaks below, were clearly the thousand Lacedaemonians who helped the oligarchs, according to Thucydides v. 81 (cf. Plutarch, *Alcib.* 15).

AENEAS TACTICUS

λαμβάνουσι τὰς εἰς τὴν ἀγορὰν φερούσας ὁδοὺς
φυλακαῖς καὶ δυνάμεσι πολλαῖς, κώλυμα γοῦν¹ οὐ
6 μικρὸν τοῖς βουλομένοις νεωτερίζειν. ἄριστον δὲ
τὰς ἀρχὰς πρῶτον μετὰ τῆς προηρημένης² δυνά-
μεως ἱεροποιῆσαι, τούτων δὲ ἐκ τοῦ ὄχλου ἀπαλλα-
γόντων, οὕτω τοὺς ἄλλους συνιέναι.

XVIII.

Ὅταν δὲ οἱ ἐκπορευθέντες³ παραγένωνται καὶ
δειλὴ γίγνηται, σημαίνει⁴ δειπνοποιεῖσθαι καὶ
εἰς φυλακὴν ἰέναι. ἐν ᾧ οἱ φύλακες εὐτρεπίζονται,
ἐν τούτῳ περὶ τῶν πυλῶν ἐπιμελητέον ὅπως
καλῶς κλείωνται· καὶ γὰρ⁵ περὶ τὰς βαλάνους
2 μαλακίας. ὅταν γὰρ ἐπὶ τὰς πύλας τις αὐτῶν
ἐλθὼν κλείσαι μὴ αὐτουργὸς γίγνηται, ἀλλὰ
παραδοὺς τὴν βάλανον τῷ πυλωρῷ κλείσαι κελεύη,
τάδε κακουργεῖται ὑπὸ πυλωρῶν βουλομένων
3 νυκτὸς δέξασθαι τοὺς πολεμίους. ὁ μὲν τις

¹ Köchly and Rüstow: οὐν M.

² Meier: προειρημένης M.

³ Meineke: εἰσπορευθέντας M.

⁴ Casaubon: σημαίνει M.

⁵ Oldfather (cf. xxiii. 2): κλείωνται (space of 5 letters) περὶ
πέρτασ M: γὰρ B in margin (for πέρτασ): περὶ γὰρ τὰς
Casaubon.

¹ For understanding the following passage it is perhaps necessary to observe that ancient city gates, which were regularly two-valved and opened inward, were locked by passing a long bar from jamb to jamb. In the upper surface of the opening into one of the jambs in which the bar rested, a deep socket was cut and a hole bored through the bar at the point which overlay this socket. Through this hole and into this socket was then dropped the bolt-pin,

guards and numerous forces take possession of the roads leading to the market-place—truly no slight hindrance to those who wish to begin a revolution. It is best for the officials to begin the celebration accompanied by the previously selected force, and only after these have been separated from the populace to allow the others to come.

XVIII.

And whenever those who have gone out return and it is late afternoon, one should give the signal for the evening meal and for mounting guard; and while the guards are making ready care must be taken that the gates are well locked, since many mistakes are made about the bolt-pins as the result of slackness on the part of the authorities. For when any of them goes to lock the gate, yet does not do so with his own hands, but gives the bolt-pin over to the gate-keeper and orders him to lock it, the following sorts of mischief are done by gate-keepers who wish to admit the enemy by night.¹

a metal cylinder, in such a way that approximately one half of it would be in the socket, the other half in the hole in the bar, but that its top should be below the upper surface of the bar, so that it could not be pulled out by any chance comer. In order to extract the bolt-pin it was necessary, therefore, to have a key so shaped as to reach down into the hole, while the bolt-pin and the key had to be fitted to one another by hooks or catches, so that the key could take firm hold of the pin and draw it out.—The above note follows the results of Köchly and Rüstow's elaborate discussion of the passage. For modern survivals in Greece and elsewhere of this general method of locking by means of a bar and a bolt-pin see H. Diels, *Antike Technik* (1920), 40 ff., and the literature cited there.

AENEAS TACTICUS

- ἡμέρας εἰς τὴν βαλανοδόκην τῶν πυλῶν ἄμμον προενέβαλεν, ὅπως ἡ βάλανος ἔξω μένη καὶ μὴ¹ ἐμβάλληται εἰς τὸ τρύπημα. φασὶ δὲ καὶ ἐμβεβλημένας² βαλάνους ὧδε ἐξαιρεθῆναι. ἐμβαλλομένης κατ' ὀλίγον ἄμμου εἰς τὴν βαλανοδόκην σείεσθαι ἀψοφητί, ἵνα μηδεὶς αἰσθηται. μετέωρος οὖν ἡ βάλανος ἐγίγνετο προσπιπτούσης τῆς ψάμμου, ὥστε ῥαδίως αὐτὴν ἐξαιρεθῆναι.
- 5 Ἦδη δὲ πυλωρός δεξάμενος τὴν βάλανον παρὰ στρατηγοῦ ἐμβαλεῖν, ἐντεμὼν λάθρα σμίλη³ ἢ ρίνη τὴν βάλανον, βρόχον λίνου περιβαλὼν ἐνέβαλεν, εἶτα μετ' ὀλίγον τῷ λίνῳ ἀνέσπασεν.
- 6 ἄλλος δὲ προετοιμάσας ἐν γυργάθῳ λεπτῷ ἐνέβαλεν⁴ προσημμένον λίνου, καὶ ὕστερον ἀνέσπασεν. ἐξηρέθη δὲ καὶ ἀνακρουσθεῖσα ἡ βάλανος. ἔτι δὲ καὶ θερμασίῳ λεπτῷ ἐξηρέθη· χρή δὲ τοῦ θερμαστίου τὸ μὲν ἐν μέρος εἶναι οἷον σωλήνα, τὸ δὲ ἕτερον πλατύ, ὥστε τῷ μὲν σωληνοειδεῖ ὑπολαμβάνειν τὴν βάλανον, τῷ δὲ ἐπιλαμβάνειν.
- 7 ἕτερος δὲ ἔλαθεν τρέψας τὸν μοχλὸν μέλλων ἐμβάλλειν, ἵνα μὴ κατέλθῃ εἰς τὸ τρύπημα ἡ βάλανος καὶ ὕστερον ὠσθεῖσα⁵ ἀνοιχθῆ ἢ πύλη.⁶
- 8 Περὶ Ἀχαΐαν δὲ ἐν πόλει⁷ . . . ἐπιχειροῦντες κρυφαίως δέξασθαι ξένους πρῶτον μὲν τῆς βαλάνου

¹ Casaubon: ἐξομένη μὴ M.

² ἐμβεβλημένας M.

³ Casaubon: σμηλη M.

⁴ Köchly and Rüstow: ἐβαλεν M.

⁵ Hertlein: ἐωσθεῖσα M.

⁶ Added by Köchly and Rüstow: space of four letters vacant in M.

⁷ Casaubon added Ἑραιέων from Polyænus ii. 36, but that is more than doubtful.

¹ That is, so as to fit about the cylindrical pin.

² A similar story is told about Heraea in Polyænus ii.

AENEAS THE TACTICIAN, XVIII. 3 - 8

Some one during the day has poured sand into the bolt-socket of the gate, so that the bolt may stick outside and not drop into the hole. They say, too, that bolt-pins already dropped into place have been extracted in the following manner. While sand was poured into the socket a few grains at a time, the bolt-pin was shaken noiselessly so that no one would notice it. Accordingly, as the sand worked down, the bolt-pin came to the top, so that it was easily taken out.

It has also happened that a keeper of the gate, on receiving from the general the bolt-pin to put in place, with a chisel or file surreptitiously made a groove in the pin, looped a linen thread about it, and inserted it, and then after a little drew it out by the thread. Yet another prepared a net of fine meshes to which was attached a linen thread, put the pin in that, and afterwards drew it out. The bolt-pin has also been removed by driving it up out of the socket with blows from beneath. Again, it has been removed by means of delicate pincers; and for this one part of the pincers must be grooved,¹ the other flat, so as to get an under-hold on the bolt-pin with the grooved part and an over-hold with the other. And still another, just as he was to drop the bolt-pin in place, secretly turned the bar in order that the pin might not fall into the hole and that afterwards the gate might be forced open.

In the city of . . . near the border of Achaea² certain men who were endeavouring to smuggle in mercenaries began by getting the dimensions of 36, but Heraea is an Arcadian city at a considerable distance from Achaea, and the event described by Polyænus took place between 240-235 B.C., more than a century later than the time of Aeneas.

AENEAS TACTICUS

- 9 ἔλαβον τὰ μέτρα τρόπῳ τοιῶδε. προκαθέντες ἐν τῇ ἡμέρᾳ εἰς τὴν βαλανοδόκην λίνου λεπτοῦ καὶ ἰσχυροῦ βρόχον καὶ τὰς ἀρχὰς ἔξω οὔσας ἀφανεῖς, ὡς ἐν τῇ νυκτὶ ἐνεβλήθη ἡ βάλανος, ἀνέσπασαν¹ ταῖς ἀρχαῖς² τοῦ λίνου τὸν βρόχον καὶ τὴν βάλανον, λαβόντες δὲ τὰ μέτρα αὐτῆς πάλιν καθῆκαν. ἔπειτα πρὸς μέτρα οὕτω τῆς βαλάνου βαλανάγραν
- 10 ἐποίησαντο τρόπῳ τοιῶδε. ἐχαλκεύσαντο σίφωνα τε καὶ φορμοραφίδα.³ ἦν δὲ ὁ μὲν σίφων ἐργασθεὶς καθάπερ εἶπωθε γίνεσθαι· τῆς δὲ⁴ φορμοραφίδος τὸ μὲν ὄξυ καὶ πολὺ μέρος εἴργαστο καθάπερ ταῖς ἄλλαις φορμοραφίσι, ἡ δὲ λαβὴ ἦν κοιλὴ ὥσπερ στυρακίου ἢ τὸ στελεόν⁵ ἐμβάλλεται. καὶ παρὰ μὲν τῷ χαλκεῖ ἐνεβλήθη στελεόν, ἀπενεχθέντος δὲ ἐξηρέθη, ὥστε πρὸς τὴν βάλανον⁶ προσαχθεῖσαν ἀρμόσαι. προνοητικῶς δὴ δοκεῖ ποιηθῆναι πρὸς τὸ⁷ τὸν χαλκῆα μηδὲν ὑποπτεῦσαι ὃ τε σίφων οὐ ἔνεκα ἐργασθεὶς εἶη καὶ ἡ φορμοραφίς, καὶ τὰ ἀρμενα γίνεσθαι.
- 12 Ἦδη δὲ τινες ἐν τῇ βαλανοδόκῃ οὔσης βαλάνου τὸ περίμετρον ὧδε ἔλαβον. πηλὸν κεραμικὸν περιελίζαντες ὀθονίῳ λεπτῷ καθῆκαν, ἀρμένω πιέζοντες περὶ τὴν βάλανον τὸν πηλόν· ἔπειτα ἀνέσπασαν τὸν πηλόν καὶ ἔλαβον τὸν τύπον τῆς βαλάνου, πρὸς ὃν τὴν βαλανάγραν ἐποίησαντο.
- 13 Συμβάλλεται⁸ γενέσθαι Τημένω Ῥοδίῳ ἐν Ἰωνίᾳ

¹ Orelli: ἀνέσπασεν M.

² Lange: τὰς ἀρχὰς M.

³ L. Dindorf: φορμοροφίδα M (and so below where M has only one ρ).

⁴ Köchly and Rüstow: τε M.

⁵ R. Schöne: * (lacuna of thirty letters) στελέα M.

⁶ σίφωνα Köchly.

⁷ Köchly and Rüstow: πρὸς τῷ Bchrendt: πρῶστε M.

AENEAS THE TACTICIAN, XVIII. 8 - 13

the bolt-pin in the following manner. During the day they let down into the socket a loop of fine and strong linen thread, the ends of which were outside but not in sight, and when at night the bolt-pin was put in place, with the ends of the thread they pulled up the loop and the pin, took its dimensions, and replaced it. Next they made a pin-hook to fit the dimensions of the pin thus taken, in the following manner. They had a tube made and a needle for sewing rush-mats. Now the tube was made in the usual fashion, but the mat-needle had the point and the longer end made like other such needles, while the head was hollow like that of a spike at the butt of a spear into which the shaft is fitted; and at the blacksmith's shop a shaft was fitted into it, but when they took it home this was removed, so that the head fitted the bolt-pin when they were put together. Now that seems a very shrewd device to prevent the blacksmith from suspecting the purpose for which the tube and the mat-needle were made and the fittings devised.

Some other men once, while the bolt-pin was in the socket, got its measurements in the following manner. They wrapped a lump of potter's clay in a fine linen cloth and let it down into the socket, pressing the clay about the bolt-pin with a tool: then they drew up the clay, took a cast of the pin, and made the key to fit.

The great city of Teos in Ionia once came very near

⁸ Herm. Schöne suggests *παρ' ἐλάχιστον ἦλθεν ὑποχείριος* in place of *συμβάλλεται*, because it appears that the town was not actually captured; the end of the narrative, however, § 19, is suspiciously abrupt.

AENEAS TACTICUS

Τέως πόλις εὐμεγέθης πρόδοτος¹ ὑπὸ τοῦ πυλωροῦ.
 ἄλλα τε οὖν προσυνέθεντο καὶ νύκτα ἀσέληνον καὶ
 σκοτεινήν, ἐν ἧ ἔδει τὸν μὲν ἀνοίξαι, τὸν δὲ μετὰ
 14 ξένων εἰσελθεῖν. ἐπεὶ δ' ἔδει² εἰς τὴν ἐπιούσαν
 νύκτα πραχθῆναι, παρῆν τῷ πυλωρῷ ἀνὴρ ὅστις
 ἐπεὶ ὀψέ ἦν καὶ φυλακαὶ τε ἐπὶ τοῦ τείχεος καθ-
 ἴσταντο καὶ αἱ πύλαι ἔμελλον κλείεσθαι, σκότους
 οὖν ἤδη ὄντος, ἀπηλλάσσετο, ἐκδήσας ἀρχὴν
 ἀγαθίδος³ λίνου κλωστοῦ, ὅπερ οὐκ ἔμελλεν
 15 ῥαδίως διαρραγῆναι. τὴν δὲ ἀγαθίδα ἐπορεύθη⁴
 ἀπελίσσων⁵ ἀπὸ τῆς πόλεως πέντε στάδια, ὅπη
 16 ἔμελλον οἱ εἰσπορευσόμενοι⁶ ἤξειν. ἐπεὶ δὲ
 παρῆν ὁ στρατηγὸς κλείσαι τὰς πύλας, καὶ ἔδωκε
 κατὰ τὸ ἔθος τῷ πυλωρῷ ἐμβαλεῖν τὴν βάλανον,
 δεξάμενος ἐνέτεμεν λαθραίως ἀσοφητὶ ρίνῃ ἢ
 σμίλῃ⁷ τὴν βάλανον, ὥστε ἐνέχεσθαι λίνον. εἴτα
 βρόχον περιθεῖς καθῆκε τὴν βάλανον ἐχομένην
 ὑπὸ τοῦ λίνου· μετὰ δὲ ταῦτα κινήσας τὸν μοχλὸν
 καὶ ἐπιδείξας τῷ στρατηγῷ κεκλεισμένην τὴν
 17 πύλην εἶχεν ἡσυχίαν. χρόνου δὲ προϊόντος ἀνα-
 σπάσας τὴν βάλανον, τὴν ἀρχὴν τοῦ σπάρτου
 πρὸς αὐτὸν⁸ ἔδησεν τοῦδε ἕνεκεν, ὅπως,⁹ εἰ
 καθυπνώσας τύχοι,¹⁰ ἐγερθεῖη σπώμενος ὑπὸ τοῦ
 18 λίνου. ὁ δὲ Τῆμενος παρῆν διεσκευασμένος μεθ'
 ὧν ἔμελλεν εἰσπορεύεσθαι εἰς χωρίον ῥητὸν πρὸς
 τὸν τὴν ἀγαθίδα ἔχοντα. ἦν δὲ προσυγκείμενον

¹ Schenkl: προειδότης M (defended by Hunter who follows Hug placing ὑπὸ before Τημένω).

² Haase: δὲ M.

³ Casaubon: ἀκανθίδος M (and similarly below).

⁴ Casaubon: ἐπορεύθη M.

⁵ Hertlein: ἀπελίσσων M.

⁶ Hertlein: εἰσπορευόμενοι M.

⁷ Casaubon: σμίλη M.

⁸ Hercher: αὐτὸν M.

⁹ Hercher: ὅτι M.

falling into the hands of Temenus the Rhodian through the treachery of the gate-keeper.¹ Among other things they agreed upon a dark, moonless night, on which one was to open the gate and the other to enter with mercenaries. Now when the plan was to be put into execution the following night, a man came up to the gate-keeper late in the evening, when the guards were stationed on the wall and the gates were about to be locked, as it was already dark, and then disappeared, after first making fast the end of a ball of twisted linen cord, which was not likely to be easily broken. He went away, unrolling the ball as he went, until he reached a spot five stadia² from the city, where the troops which were to enter would come. Then, when the general came to lock the gates, and as usual gave the gate-keeper the bolt-pin to put in place, the latter took it, and with a file or a chisel, noiselessly and without attracting attention, cut a groove in it so that a thread would catch it. He then slipped a loop over the pin and let it down with the thread attached to it. After that he shook the bar, showing the general that the gate was locked, and held his peace. Some time after he drew up the pin and tied the end of the cord to himself, so that if he should happen to fall asleep he would be awakened by a pull at the cord. Now Temenus, provided with the forces which were to enter with him, came near to a place agreed upon with the man who had the ball of cord. And a

¹ Nothing further is known about the incident described here.

² Approximately one-half mile.

¹⁰ L. Dindorf: *τύχη* M.

AENEAS TACTICUS

- τῷ Τημένῳ πρὸς τὸν πυλωρὸν ἐλθόντι¹ εἰς τὸν
 19 χῶρον σπᾶν τὸ² σπάοτον. καὶ εἰ μὲν ἦν ἔτοιμα
 τῷ πυλωρῷ ἄπερ ἤθελε, προσεπιδηῆσαι³ πρὸς τὴν
 ἀρχὴν τοῦ λίνου μαλλὸν ἐρίου καὶ ἀφείναι, ὅπερ
 ἰδὼν ὁ Τήμενος ἔμελλεν σπεύδειν πρὸς τὰς πύλας·
 εἰ δ' ἀπετύγχανεν ὁ πυλωρὸς τοῦ θελήματος . . .⁴
 οὐδὲν προσάψας ἀφήκεν τὸ λίνον,⁵ ὥστε τὸν
 Τήμενον ἐκ πολλοῦ φθάσαι τε καὶ λαθεῖν ἀπαλ-
 λαγέντα.⁶ ἠσθάνοντο οὖν ἐν τῇ νυκτὶ τὸ σπάρτον
 ὑπάρχον . . .⁷ ἐν τῇ πόλει, οὐχ οἷόν τε ἦν προϊέναι.
- 20 Τρόπον δὲ κατὰ τόνδε προεδόθη πόλις ὑπὸ
 πυλωροῦ. σύνηθες ἐποιήσατο, ἐπεὶ μέλλοιεν αἱ
 πύλαι κλείεσθαι, ὑδρίον ἔχων ἐξιέναι⁸ ὡς ἐφ' ὕδωρ.
 ἀφικνούμενος δὲ ἐπὶ τὴν κρήνην⁹ λίθους ἐτίθει εἰς
 τόπον γνωστὸν τοῖς πολεμίοις, ἐφ' οὗ φοιτῶντες
 εὔρισκον διὰ τῶν τιθεμένων λίθων ἄπερ θέλοι
- 21 δηλοῦν ὁ τῆς πόλεως φύλαξ. εἰ μὲν γὰρ πρώτην
 φυλάσσοι,¹⁰ ἓνα λίθον¹¹ ἐτίθει πρὸς τὸν συγκεί-
 μενον τόπον, εἰ δὲ δευτέραν, δύο, εἰ δὲ τρίτην,
 τρεῖς,¹² εἰ δὲ τετάρτην, τέτταρας. ἔτι δὲ καὶ ἡ¹³
 τοῦ τείχους καὶ κατὰ τι¹⁴ τῶν φυλακῶν¹⁵ λελόγχοι,
 τούτῳ δοῦν¹⁶ τῷ τρόπῳ σημαίνων ἐνέδωκεν.
 ταῦτα δεῖ οἷν συμβαλλόμενον πάντα φυλάττεσθαι

¹ Hertlein: ἐλθὼν M.

² Köchly and Rüstow: τὸν M.

³ Casaubon: προσπηδησαι M.

⁴ Capps and Rouse indicate a lacuna.

⁵ Hertlein: τὸν λίνον M.

⁶ Casaubon: ἀπαλλαγέντασ M.

⁷ R. Schöne suggests ἀνευ μαλλοῦ and an indication that from this Temenus concluded that conditions were unfavourable for his attempt.

⁸ Casaubon: εἰσιέναι M.

⁹ Casaubon: κλίην M.

previous arrangement had been made with the gate-keeper that Temenus was to pull the cord when he reached the spot, and if the keeper had things ready as he wished, he was to tie a flock of wool to the end of the cord and let it go, and, when Temenus saw that, he was to hurry to the gate. But in case of failure to secure what he wished [he was to let the cord go without anything tied to it. Accordingly] he let the cord go without anything tied to it, so that Temenus with a long start got away without being discovered. They found out accordingly in the night that the cord was [. . . so because the situation was unfavourable] in the city it was impossible to proceed.

Here is also another way in which a city was betrayed by a gate-keeper. He made it his custom to go out with a water-jug, as though for water, when the gates were about to be locked. On arriving at the spring he would put stones in a spot known to the enemy, who, when reaching the place, found out by means of the stones just what the city watchman wished to reveal. For if he was to keep the first watch, he would place one stone at the prearranged spot, if the second, two, if the third, three, if the fourth, four. Furthermore, by giving signals in this fashion, he furnished information both as to what position on the wall and to which detachment of the guards he had been assigned by lot. Accordingly, with all this in mind, the officer should be on

¹⁰ Köchly and Rüstow: φυλάσσοιεν AB.

¹¹ Casaubon: ἀνθ' ὧν AC (ἀνθῶν B).

¹² Casaubon: τριτησ M.

¹³ Casaubon: ἡ ABC.

¹⁴ Orelli: τι M.

¹⁵ Köchly and Rüstow: φυλάκων M.

¹⁶ R. Schöne (sc. δη οὖν): δ' οὖν ABC.

AENEAS TACTICUS

καὶ τὰς πύλας αὐτὸν τὸν ἄρχοντα κλείειν καὶ μὴ ἄλλω διδόναι τὴν βάλανον.

- 22 . . .¹ πράσσοντα δέ τι τοιοῦτον τὸν μοχλὸν ἀφανίζειν· ἤδη γάρ τινες ἐπιφανέντες ὑπεναντίοι ἐβιάσαντο πάλιν κλείσαι, τοῦ μοχλοῦ παρόντος. διὸ δεῖ πάντα τὰ τοιαῦτα προνοεῖν.

XIX. [Μοχλοῦ πρίσις]

Διαπρίοντα δὲ μοχλὸν ἔλαιον ἐπιχεῖν· θάσσον γὰρ καὶ ἀσοφητὶ μᾶλλον πρισθήσεται. εἰ δὲ καὶ σπόγγος ἐπὶ τε τὸν πρίονα καὶ τὸν μοχλὸν ἐπιθεθῆ, πολλῶ κωφότερος ὁ ψόφος² ἔσται. πολλὰ δ' ἂν τις καὶ ἄλλα ὁμότροπα τούτοις γράψαι. ἀλλὰ ταῦτα μὲν παρετέον.

XX. [Κώλυμα τῶν περὶ μοχλοῦς καὶ βαλάνους κακουργημάτων]

Εἰς δὲ τὸ τούτων μηδὲν κακουργεῖσθαι χρῆ πρῶτον μὲν στρατηγὸν μὴ δεδειπνηκότα δι' αὐτοῦ³ τὴν κλείειν καὶ τὴν ἐπιμέλειαν ποιεῖσθαι, μηδὲ ἄλλω πιστεύειν ῥαθύμως διακείμενον· ἐν δὲ τοῖς⁴ ἐπικινδύνοις καὶ πάμπαν σύννου δεῖ² περὶ ταύτην εἶναι. ἔπειτα τὸν μοχλὸν σεσιδηρῶσθαι διὰ μήκους τριχῆ ἢ τετραχῆ· ἄπριστος γὰρ ἔσται. ἔπειτα βαλάνους ἐμβάλλεσθαι τρεῖς μὴ ὁμοτρόπους, τούτων δὲ ἕκαστον φυλάττειν

¹ Hercher indicated the lacuna: a short space in M.

² Haupt: κωφότερος ὁ μοχλὸς M.

³ Hertlein: αὐτοῦ M.

⁴ Added by Hertlein.

his guard, should lock the gate himself, and should not give the bolt-pin to anyone else.

. . . When engaged in any such enterprise one ought to conceal the bar ; for it has happened that opponents have appeared and locked the gate again by force because the bar was still there. And so one should make provision for all such contingencies.

XIX. [*Sawing through a Bar*]

In sawing through a bar pour on oil ; for thus the sawing will go faster and with less noise. And if a sponge¹ be tied to the saw and to the bar, the noise will be much less distinct. One might write down many other similar suggestions, but we may let them pass.

XX. [*Prevention of Tampering with Bars and Bolt-pins*]

To prevent deception of the kinds just mentioned, in the first place the general ought before dining to give personal attention to the locking of the gate, and not carelessly to trust to anyone else, while in dangerous situations he must be extremely vigilant about this. Next, the bar should have three or four strips of iron from end to end, for thus it cannot be sawed through. Then, three dissimilar bolt-pins should be put in, and each general is to have one of

¹ He probably means that the sponge should have been first soaked in oil. In that way it would feed oil steadily and uniformly. This is one of the very few suggestions for the assailants of a beleaguered city rather than its defenders. It is clearly an afterthought on his part, and would have been relegated to a footnote were he writing under modern conditions.

AENEAS TACTICUS

ἀνὰ μίαν¹ τῶν στρατηγῶν· εἰ δὲ πλείονες εἴησαν,
 3 πάλω καθ' ἡμέραν τοὺς λαχόντας. ἄριστον δὲ
 τὰς βάλανους μὴ ἐξαιρετὰς εἶναι, ὑπὸ δὲ λοπίδος
 σιδηρᾶς κατέχεσθαι, ἵνα μὴ πλέον ἐξαιρομένη
 μετεωρίζηται τῷ καρκίνῳ ἢ ὥστε τὸν μοχλὸν
 ὑπωθεῖσθαι² ἐπικλειομένων τῶν πυλῶν καὶ ἀνοι-
 γομένων· τὸν δὲ καρκίνον ἐσκευάσθαι, ὅπως ὑπὸ
 τὴν λοπίδα καθίηται³ καὶ ραδίως τὴν βάλανον
 4 μετεωρίζη. Ἀπολλωνιάται δὲ οἱ ἐν τῷ Πόντῳ
 παθόντες τι τῶν προγεγραμμένων κατεσκευάσαν
 τὰς πύλας κλείεσθαι ὑπὸ σφύρας τε μεγάλης καὶ
 κτύπου παμμεγέθους γιγνομένου, ὡς σχεδὸν κατὰ
 πᾶσαν τὴν πόλιν ἀκούεσθαι ὅταν κλείωνται ἢ
 ἀνοίγωνται αἱ πύλαι· οὕτω μεγάλα τε καὶ σε-
 5 σιδηρωμένα ἦν τὰ⁴ κλείθρα. τὸ δὲ αὐτὸ καὶ ἐν
 Αἰγίνῃ. ὅταν δὲ αἱ πύλαι κλεισθῶσιν, τοῖς φύλαξι
 σύνθημα καὶ παρασύνθημα δόντας ἐπὶ τὰ φυλάκια
 διαπέμψαι.

XXI.

Περὶ δὲ ἀρμένων ἐτοιμασίας καὶ ὅσα χρή⁵ περὶ
 χώραν φιλίαν προκατασκευάζειν⁶ καὶ τὰ ἐν
 τῇ χώρᾳ ὡς δεῖ ἀφανίζειν ἢ ἀχρεῖα⁸ ποιεῖν τοῖς
 ἐναντίοις ὧδε μὲν⁹ παραλείπεται· ἐν δὲ τῷ
 Παρασκευαστικῷ περὶ τούτων τελείως δηλοῦται.
 2 περὶ δὲ φυλάκων καταστάσεως καὶ περιουσιῶν¹⁰
 καὶ πανείων καὶ συνθημάτων καὶ παρασυνθη-

¹ R. Schöne: ἀνδρα M.

² Eberhard: ὥστε μοχλῷ ὑποθεῖσθαι M.

³ "Nescio quis" in Hercher's ed.: κάθηται M.

⁴ R. Schöne: πάντα M.

⁵ Added by Hercher.

⁶ Casaubon (C?): προκατασκευάζε AB.

these in his keeping ; if, however, there should be more than three generals, then the custody of the bolt-pins must be determined each day by lot. But the best thing is to have the bolt-pins so that they cannot be removed but are held in place by an iron plate, so that when it is raised up the pin cannot be lifted higher by the pincers than just enough to slip the bar under when the gate is closed and opened, while the pincers must be so made that they can pass under the plate and easily lift the bolt-pin. The citizens of Apollonia Pontica, after having had one of the experiences already described, provided that the gates should be locked with a great hammer and the making of a tremendous noise, so that the locking or opening of the gates could be heard over almost the entire city, so ponderous were the fastenings and so strengthened with iron ; and the same thing was done in Aegina also. When the gates are locked, give the guards password and answer and send them to their posts.

XXI.

Provision of tools, and all suitable preparations on friendly soil, and the methods necessary for concealing the property in the land or for rendering it useless to one's opponents, are here omitted, but these have been fully set forth in the book on *Military Preparations*. About the disposition of guards and patrols, however, and panics, and watch-words, and countersigns, the greater part will have

⁷ Oldfather: *καὶ εἰ* A *καὶ ἢ* B : *καὶ δὴ* R. Schöne.

⁸ Casaubon: *ἡχρεία* M.

⁹ Herm. Schöne: *με* AB (*μοι* B in margin).

¹⁰ Hertlein: *περιοδιῶν* M.

AENEAS TACTICUS

μάτων τὰ μὲν πολλὰ ἐν τῇ Στρατοπεδευτικῇ βίβλῳ γραπτέον ὄν τρόπον δεῖ γενέσθαι, ὀλίγα δὲ αὐτῶν καὶ νῦν δηλώσομεν.

XXII. [Φυλακαί]

Νυκτοφυλακεῖσθαι ἐν μὲν τοῖς κινδύνοις καὶ προσκαθημένων¹ ἤδη ἐγγὺς πολεμίων πόλει ἢ
 2 στρατοπέδῳ ὧδε.² τὸν μὲν στρατηγὸν³ τὸν τοῦ
 ὄλου ἡγεμόνα καὶ τοὺς μετ' αὐτοῦ τετάχθαι
 κατὰ⁴ τὰ περιαρχεῖα καὶ τὴν ἀγοράν, εἰς ὄχυρό-
 τητος μετέχη· εἰ δὲ μή, προκατειληφέναι τόπον
 τῆς πόλεως ἐρυμνότατόν τε καὶ ἐπὶ πλεῖστον ἀπ'
 3 αὐτοῦ τῆς πόλεως ὀρώμενον. περὶ δὲ τὸ στρα-
 τήγιον σκηνοῦν καὶ διατελεῖν αἰεὶ τὸν σαλπικτήν
 καὶ τοὺς δρομοκῆρυκας, ἕν',⁵ εἰάν τι δέη σημηναί
 ἢ παραγγεῖλαι, ἐξ ἑτοίμου ὑπάρχωσι, καὶ οἱ τε⁶
 ἄλλοι φύλακες τὸ μέλλον αἰσθωνται καὶ οἱ περίοδοι
 ὅπου ἀν' ὄντες τύχωσι κατὰ περιοδίαν τῆς πόλεως.
 4 ἔπειτα τοὺς τε ἐπὶ τῷ τείχει φύλακας καὶ τοὺς ἐν
 τῇ ἀγορᾷ καὶ ἐπὶ τῶν ἀρχείων καὶ τῶν εἰς τὴν
 ἀγοράν εἰσβολῶν καὶ τοῦ θεάτρου καὶ τῶν ἄλλων
 κατεχομένων χωρίων διὰ βραχέων τε φυλάσσειν,
 καὶ πολλὰς εἶναι τὰς φυλακὰς καὶ ἅμα πολλοὺς
 5 ἀνθρώπους. ἐν γὰρ τῷ δι' ὀλίγου φυλάσσειν
 οὐτ' ἀν⁸ κατὰ μῆκος χρόνου δύναίτο τις πράξαι
 τι πρὸς τοὺς πολεμίους καὶ νεωτερίσαι φθάσας,
 ἤττόν τ' ἀν ὕπνοι ἐγγίγνοιτο διὰ βραχέος φυλασ-
 σόντων, τῷ⁹ τε πολλοὺς ἅμα φυλάσσειν μᾶλλον
 δύναίτο ἐκφερομυθεῖσθαι τι τῶν πρασσομένων.

¹ Meier: προσκαθημένων M.

² Added by Meier.

³ Köchly and Rüstow add ἢ after στρατηγόν.

⁴ R. Schöne: καὶ M.

⁵ Added by Casaubon.

to be written in the book on *Encampments*, but a few of these points we shall now also set forth.

XXII. [*Guards*]

To keep guard by night when danger threatens, and the enemy are already lying near the city or camp, it is necessary for the general in command of the entire force and his staff to take their post at the city-hall and the market-place, provided these be defensible; but if not, the strongest place in the whole city and the most conspicuous should have been previously occupied. Close by the general's quarters the trumpeter and the dispatch-bearers should encamp, and remain there, so that if a signal or a dispatch be needed, they may be ready at hand, and the other watchmen and the patrols wherever they may happen to be in their circuit of the city may be aware of what is to occur. Moreover, the guards upon the wall and in the market-place, and those at the municipal buildings and entrances to the market-place and at the theatre, and other occupied points, should keep guard in short watches; and there should be many guard shifts, and many men together in each. For in guarding by short watches, no one would be able, through the length of time he was on guard, to have any dealings with the enemy, or to gain headway in starting a revolution. And in short watches sleep would be less likely to steal upon the guards. Moreover, with many men on guard at once, some rumour of what is being done would be more likely to leak out. It is

⁶ Casaubon: *ἐῖτε οἱ* ABC.

⁸ Sauppe: *ὄτ' ἂν* M.

⁷ Orelli: *ἐὰν* AB.

⁹ Casaubon: *τό* M.

AENEAS TACTICUS

- 5^a ἐργηγορέναι τε ὡς πλείστους ἄμεινον ἐν τοῖς κινδύνοις καὶ πάντας¹ φυλάξαι ἐν τῇ νυκτί, ἢ ὡς πλείστοι καθ' ἐκάστην φυλακὴν προφυλάσσωσιν. εἴαν δὲ ὀλίγοι τε καὶ μακρὰς φυλάσσωσιν, ὕπνος τ' ἂν ἐγγίγνοιτο διὰ τὸ μῆκος τῶν φυλακῶν, καὶ εἴ τινές τι ἐγχειροῖεν νεωτερίσαι, ὑπάρχοι ἂν αὐτοῖς τοῦ χρόνου τὸ μῆκος καὶ φθάσαι καὶ λαθεῖν πράξαντάς τι πρὸς τοὺς πολεμίους· διὸ 7 δεῖ τὰ τοιαῦτα μὴ ἀγνοεῖν. ἔτι δὲ χρὴ ἐν τοῖς κινδύνοις καὶ τάδε προνοεῖν. τῶν φυλάκων μηδένα προγιγνώσκειν μήτε ὀπόστην² μήτε³ ὅπου φυλάξει τῆς πόλεως· μηδὲ τῶν αὐτῶν αἰετὸς τοὺς αὐτοὺς ἡγεῖσθαι, ἀλλ' ὡς πυκνότερα πάντα μεθιστάναι τὰ περὶ τὴν πολιτοφυλακίαν· οὕτω γὰρ ἂν ἤκιστα τις δύναίτο τοῖς ἔξω προδιδούς δηλοῦν τι ἢ προσδέξασθαι παρὰ τῶν πολεμίων, 8 μὴ προειδότες⁴ ὅπου τοῦ τείχους τὴν νύκτα ἔσονται μηδὲ μεθ' ὧν, ἀλλ' ἀγνοοῦντες τὸ μέλλον. καὶ τοὺς ἡμέρας φυλάξαντας μὴ φυλάσσειν νυκτός· οὐ γὰρ ἐπιτήδειον⁵ προειδέναί ἃ μέλλει ἕκαστος πράσσειν.
- 9 Προφυλάσσοιέν τ' ἂν ἐκ τῶν ἐπὶ τῷ τείχει φυλακίων⁶ προφύλακες ὧδε. ἐξ ἐκάστου γὰρ φυλακίου καθ' ἐκάστην φυλακὴν⁷ προφυλασσόντων εἰς ἀνὴρ ἐπὶ τὸ ἐχόμενον φυλάκιον, καὶ ἀπ' ἐκείνου ἄλλος εἰς τὸ ἐχόμενον, καὶ ἀπὸ

¹ R. Schöne: πάντα M.

² Mor. Schmidt: ὀπουστήναι M.

³ Meineke: μηδὲ M.

⁴ Behrendt: προειδόντων M: προειδόντων R. Schöne.

⁵ R. Schöne suggests that μηδὲ belongs after ἐπιτήδειον: Herm. Schöne thinks of a lacuna. Ought not the clauses καὶ . . . νυκτός and οὐ . . . πράσσειν to appear in reverse order? (Oldfather).

better for as many as possible to be on watch in time of peril, and for all to do guard-duty during the night, so that as many as possible may be keeping guard at each watch. But if few are on guard, and for long watches, sleep would steal upon them because of the length of the watches, and if any men should attempt a revolution, the length of the time of duty would favour them both in getting a start and in escaping detection in any dealings with the enemy. Such considerations, then, ought not to be ignored; but in times of peril one must keep still other things in mind. Thus, no one of the guards should have any previous knowledge either of the number of his watch, or where in the city he is to be on guard. Nor should the same officers always command the same men; but as frequently as possible all the regulations concerning the watching of the citizens should be changed, for thus would a traitor be least able to betray anything to outsiders, or to receive anything from the enemy, not knowing beforehand on what part of the wall he would be in the night, nor with whom, but being ignorant of what was to occur. And those who guard by day should not be employed at night, for it is not fitting that they should know beforehand what each is to do.

Guards from the stations on the wall should keep watch as follows. From each of the stations, at each change of the watch, one of the guards should go to the nearest station, and from this another to the next, and from the other stations still others

⁶ Köchly and Rüstow: φυλάκων M.

⁷ Casaubon: φυλακῆν τῶν M.

AENEAS TACTICUS

- τῶν ἄλλων ἄλλοι¹ εἰς τὰ ἄλλα· παρηγγέλω δὲ
 10 ποιεῖν ἀπαξάπαντας² τοῦτο ἀπὸ συσσήμων. καὶ
 οὕτω πολλοί τε καὶ ἅμα περιοδεύουσιν³ καὶ
 μικρὸν ἕκαστος⁴ χωρίον κινήθησεται, καὶ οὐ
 θαμὰ⁵ οἱ αὐτοὶ παρὰ τοῖς αὐτοῖς διατελοῦσι,
 πυκνὰ ἄλλων φυλάκων παρ' ἄλλοις γιγνομένων
 φύλαξιν.⁶ τούτου δὲ οὕτω πρᾶσσομένου οὐκ
 ἂν τι⁷ ἐκ τῶν φυλάκων νεωτερισθεῖη.
 11 Τοὺς δὲ προφυλάσσοντας⁸ ἀντιπροσώπους ἀλλήλοις
 ἐστάναι· οὕτως γὰρ ἂν πάντη ἀπ' αὐτῶν βλέποντο,
 καὶ ἤκιστα ὑπὸ τινων ἀγρευθεῖεν λάθρα προσελ-
 θόντων,⁹ ἅπερ ἤδη γεγονότα περὶ τὰ ἡμεροσκόπια
 12 δεδήλωται. ἐν δὲ ταῖς χειμεριναῖς καὶ σκοτειναῖς
 νυξὶν ἄλλην καὶ¹⁰ ἄλλην αὐτοὺς λίθους βάλλειν
 εἰς τὸ ἔξω μέρος τοῦ τείχους, καὶ ὡς δὴ ὀρωμένους
 τινὰς ὑπ' αὐτῶν ἐρωτῶντων τίνες εἶεν.¹¹ ἀπὸ
 ταυτομάτου γὰρ ἂν γνωσθεῖέν τινες προσπελάζοντες.
 13 ἂν δὲ δοκῆ, καὶ εἰς τὸ ἔσω μέρος τῆς πόλεως τὸ αὐτὸ
 ποιεῖν. οἱ δὲ τινες τοῦτό φασιν βλαβερὸν εἶναι·
 τοὺς γὰρ προσιόντας τῶν πολεμίων ἐν τῷ σκότει
 προαισθάνεσθαι ὅτι ἐνταῦθα οὐ προσιτητέον¹² ἐστὶ
 διὰ τὴν φωνήν τε τῶν περιόδων καὶ τὸ βάλλειν,
 14 ἀλλὰ μᾶλλον εἰς τὸν σιγῶμενον τόπον. ἄριστον
 δ' ἐν τοιαύταις νυξὶν ἔξω τοῦ τείχεος κύνας¹³

¹ Added by Köchly and Rüstow.

² Herm. Schöne: ἅπα πάντας M.

³ Meier: περιοδεύουσιν M.

⁴ Casaubon: ἕκαστον M.

⁵ Hertlein: οὐδ' ἅμα M.

⁶ Casaubon: προσφύλαξιν M.

⁷ Sauppe: ὁδῶντι M.

⁸ Kirchhoff: προφυλάσσωσιν M.

⁹ Köchly and Rüstow: προελθόντων M.

¹⁰ ἄλλην καὶ added by Casaubon.

¹¹ εἰσὶν Hercher.

¹² Mor. Haupt: προαισθάνεσθαι (space of 3-4 letters) οὐ
 προσπήγαιον M.

¹³ Casaubon: κύνας M.

AENEAS THE TACTICIAN, XXII. 9 - 14

to the remaining ones. Let everyone be ordered to do this at given signals. In this way many will make their way around the walls at the same time, and each will move but a short distance, and the same men will not often remain together, since different guards will be constantly coming in contact with one another. If this be done no act of treachery could be performed by the guards.

The guards should stand facing one another, for in this way they can see in all directions and they will rarely be caught by any foe coming secretly against them, a thing that I have noted¹ as having actually happened to day-watches. During the dark winter nights stone after stone should be thrown over the walls, and, as if persons were seen, let the guard ask, "Who goes there?", for any who might be approaching would thus be recognized without more ado. If it should seem best, this could be done also inside the city. Some, however, say this is dangerous, for a party of the enemy which might be approaching in the darkness are made aware in advance that they must not attack at this point, by the noise of the patrols and the throwing of stones, but rather at the point where there is no noise. The best plan, however, on such nights is to have dogs tied outside the wall to keep watch.² For

¹ The reference may be to Ch. vi. 6, but this precise detail is not in the form in which the treatise has come down to us, very likely as a fault of the tradition rather than an oversight on the part of the author.

² Dogs were used by the Spartan Agesipolis at the siege of Mantinea in 385 B.C. (Polyaenus ii. 25); by Philip of Macedon for tracking down his foes in the Balkan mountains (*ibid.* iv. 2. 16); by Aratus for guarding the key fortress of Acrocorinth after its capture in 243 B.C. (Plutarch, *Aratus*, 24); and Vegetius iv. 26 recommends that they be used

AENEAS TACTICUS

- προσδεδέσθαι νυκτερεύοντας, οἵπερ ἐκ πλείονος ἐμφανιοῦσιν τὸν ἐκ τῶν πολεμίων κατάσκοπον ἢ αὐτόμολον προσπελάζοντα τῇ πόλει λαθραίως ἢ πῃ ὀρμώμενον αὐτομολοῦντα· ἅμα δὲ καὶ τὸν φύλακα, εἴαν τύχη καθεύδων, ἐγείρουσι διὰ τὸν ὑλαγμόν.
- 15 Ἡ¹ δ' ἂν τῆς πόλεως εὐπρόσοδα καὶ εὐεπίθετα τοῖς πολεμίοις ἢ, τῇδε φύλακας καθιστάναι τοὺς τὰ πλείστα κεκτημένους καὶ ἐντιμοτάτους τε καὶ τῶν μεγίστων μετέχοντας τῇ πόλει· μάλιστα γὰρ ἂν αὐτοῖς προσήκοι μὴ πρὸς ἡδονὰς τραπέσθαι, ἀλλὰ μεμνημένους ἂν τὸν νοῦν² προσέχειν.
- 16 ἐν³ δὲ ταῖς πανδήμοις ἑορταῖς χρῆ τῶν κατὰ πόλιν φυλάκων ὅσοι ἐν σώμασι μάλιστα ὑποπτοι τοῖς αὐτῶν⁴ καὶ ἄπιστοι, ἀφίεσθαι ἀπὸ τῶν φυλακείων
- 17 κατ' οἰκίας ἑορτάζειν. καὶ ἅμα⁵ μὲν πολυωρεῖσθαι δόξουσιν, ἅμα δὲ οὐδὲν ἂν ἐπ' αὐτοῖς εἶη πράξιαι. ἀντὶ δὲ τούτων ἄλλους εἰς τὰ φυλακεῖα καθιστάναι πιστοτέρως ἔχοντας· περὶ γὰρ τὰς ἑορτὰς καὶ⁶ τοὺς τοιούτους καιροὺς μάλιστα οἱ βουλόμενοί τι νεωτερίζειν ἐγχειροῦσιν.
- 18 ὅσα δὲ πάθεα γέγονε περὶ τοὺς τοιούτους⁷ καιροὺς, ἐν ἄλλοις δηλοῦται.
- 19 Μᾶλλον⁸ δὲ ἅμα τούτοις μηδὲ τὰς ἀναβάσεις ἐπὶ τὸ τεῖχος εὐπόρους εἶναι ἀλλὰ κλειστάς, ἵνα μηδενὶ ἐγγίγνηται προκαταλαμβάνειν τι⁹ τοῦ τεύχους βουλο-

¹ Casaubon: ἡ M. ² Capps: space of 4-5 letters in M.

³ Added by Haase. ⁴ Köchly and Rüstow: αὐτῶν M.

⁵ Casaubon: ἄλλα M.

⁶ Added by Köchly and Rüstow thinking that it was in M.

⁷ Casaubon: τοῦ στοιχείου τοὺς M.

⁸ Herm. Schöne: ὅμαλον M.

⁹ Kirchhoff: ἔτι M.

AENEAS THE TACTICIAN, xxii. 14 - 19

they will detect at a greater distance the presence of a hostile spy, a deserter who is stealthily approaching the city, or one who is somewhere making his way out to desert; they will also by their barking rouse the sentinel if he happens to be asleep.

If any part of the city is easily accessible and exposed to the attacks of the enemy, the sentinels stationed there should be the wealthiest and most highly respected citizens and those who hold the most important offices in the city. For it would be in the highest degree to the interest of such men not to turn aside to pleasures, but rather, bearing in mind their position, to maintain a vigilant watch. At the time of the public festivals those of the city guards who are greatly suspected and distrusted by their own comrades should be sent away from their posts to celebrate the festival at home. For they will think that they are being honoured and at the same time would have no opportunity to carry out any plot. And in their places more trustworthy men should be assigned to guard duty; for during the festivals and on such occasions revolutionists are extremely likely to venture on some enterprise. An account of the disturbances which have arisen on such occasions has been given elsewhere.

It is better, moreover, that the ramps leading to the top of the wall should not be open, but rather be kept closed, thus rendering it impossible for anyone desirous of betraying the city to the

for guarding the walls at night, along with geese, which made themselves famous by saving the Capitol from the Gauls. See also below, § 20, for the use of dogs by Nicocles.

AENEAS TACTICUS

- μένω ἐνδοῦναι τοῖς πολεμίοις, ἀλλ' ὧσιν οἱ¹ φύλακες οὓς ἂν σὺ βούλῃ² ἐξ ἀνάγκης ἐπὶ τοῦ τείχους διατελοῦντες καὶ μὴ καταβαίνοντες, ἂν τέ τινας ἔξωθεν τῆς πόλεως λάθωσιν ὑπερβάντες, μὴ ῥαδίως διὰ ταχέων καταβαίνωσιν³ ἀπὸ τοῦ τείχους εἰς τὴν πόλιν, ἐὰν μὴ θέλωσιν ἀφ' ὑψηλῶν⁴ καταπηδῶντες κινδυνεύειν καὶ μήτε λαθεῖν μήτε φθάσαι. πρέποι⁵ δ' ἂν τὸ παρασκευάσμα τοῦτο περὶ τὰς
- 20 ἀναβάσεις καὶ ἐν τυράννου ἀκροπόλει. μετὰ δὲ τὴν ἐν Νάξῳ⁶ ναυμαχίαν ἐπιβουλευόμενος⁷ ὁ φρούραρχος Νικοκλῆς ἀναβάσεις κλειστὰς ποιήσας κατέστησε φύλακας⁸ ἐπὶ τῷ τείχει, ἔξω δὲ τῆς πόλεως περιοδίας ἐποιεῖτο μετὰ κυνῶν· προσεδέχοντο γὰρ ἔξωθέν τινα ἐπιβουλήν.
- 21 Ἐν ὁμοιοῦσι δὲ καὶ μηδενὸς ὑποπτεύοντος ἐν τῇ πόλει ἐν τοῖς ἐπὶ⁹ τῷ τείχει φυλακείοις δεῖ τὰς νύκτας λύχνα καίεσθαι ἐν¹⁰ λαμπτήρσιν, ἵνα καθ' οὓς ἂν τι προσπελάζῃ πολέμιον, ἄρωσι τῷ στρατηγῷ
- 22 τὸν λαμπτήρα. ἐὰν δὲ¹⁰ μὴ φαίνεται πρὸς τὸν στρατηγὸν ὁ λαμπτήρ τόπου κωλύοντος, ἄλλος διαδεκτῆρ ὑπολαμβάνων λαμπτήρι φαιέτω τῷ στρατηγῷ, ὁ δὲ στρατηγὸς τὸ ἐμφανιζόμενον αὐτῷ τοῖς ἄλλοις φύλαξι δηλοῦτω σάλπιγγι ἢ¹⁰

¹ Added by Capps. ² Hertlein: βούλει M.

³ Casaubon: καταβαίνουσιν AB.

⁴ Hertlein: ἀπαλλήλων M.

⁵ Casaubon: προτρέποι M (ABC).

⁶ Casaubon: τὴν ἔξω M: ἐν Κιτίῳ Köchly and Rüstow.

⁷ Casaubon: ἐπιβουλευομένοις M.

⁸ φυλακὰς Behrendt.

⁹ τοῖς ἐπὶ added by Köchly and Rüstow.

¹⁰ Added by Casaubon.

¹ If Casaubon's conjecture be right we have a reference
114

enemy to seize part of the wall in advance, and that the sentinels, men of your choice, may be obliged to remain constantly on the wall and not come down. Then if any enemy, attacking the city from the outside, should succeed in scaling the wall by surprise, they could not easily and quickly descend from the wall into the city, unless they were willing to take the risk of leaping down from high places and to forgo the advantages of surprise and initiative. This method of guarding the ramps would be suitable also for the citadel of a prince. After the naval battle off Naxos,¹ Nicocles, the commander of the garrison, inasmuch as plots were being formed against him, closed the ramps, posted sentinels on the walls, and kept up a patrol with dogs outside the city; for the people were expecting a treacherous attack from without.

When the people are united and no one in the city cherishes suspicions, lamps set in lanterns should be kept burning throughout the night at the posts of the sentinels on the wall, so that if a hostile movement should be directed against any of them, they may raise the lantern as a signal to the commander. If the nature of the ground prevents the light from reaching the commander, another guard, as a relay, should with his lantern give the signal to the commander, who, either with the bugle or by means of dispatch-bearers, as the circumstances may demand, should transmit to the rest of the

to the famous battle off Naxos in 376 B.C., in which Athens won back her supremacy at sea. On the other hand, if Köchly and Rüstow's suggestion *ἐν Κιτίῳ* be followed, the great defeat of Evagoras of Cyprus by the Persians in 380 B.C. is meant. The latter had a son Nicocles, well known from the works which Isocrates addressed to him.

AENEAS TACTICUS

- 23 τοῖς δρομοκήρυξιν, ὁποτέρως¹ ἂν συμφέρη. κατὰ δὲ τοὺς καιροὺς τούτους καὶ οὕτω περὶ τὰς φυλακὰς διατελούντων παραγγελλέσθω τῷ ἄλλω ὄχλῳ, ὅταν σημαυθῇ,² μηδένα ἐξιέναι· ἐὰν δέ τις ἐξίῃ ἐπὶ τινα πράξιν ἀναγκαῖον, μετὰ λαμπτήρος πορεύεσθαι, ἵνα πόρρωθεν κατάδηλος ᾖ
- 24 τοῖς περιοδεύουσι. μηδ' ἐργάζεσθαι μηδένα δημιουργὸν ἢ χειροτέχνην, ἵνα μὴ ψόφοι ἀπὸ τινων γίνωνται τοῖς φύλαξιν.
- Ὅν δ' ἂν τρόπον ἴσως καὶ κοινῶς μακροτέρων ἢ βραχυτέρων νυκτῶν γινομένων καὶ πᾶσιν αἱ φυλακαὶ γίνωντο, . . .⁴ πρὸς κλεψύδραν χρὴ φυλάσσειν, ταύτην δὲ συμμεταβάλλειν διὰ δεχημερίδος.⁵
- 25 μᾶλλον δὲ αὐτῆς κεκηρῶσθαι τὰ ἔσωθεν, καὶ μακροτέρων μὲν γινομένων τῶν νυκτῶν ἀφαιρεῖσθαι τοῦ κηροῦ, ἵνα πλέον ὕδωρ χωρῇ, βραχυτέρων δὲ προσπλάσσεσθαι,⁶ ἵνα ἔλασσον δέχεται. περὶ μὲν οὖν φυλακῶν ἰσότητος ἱκανῶς⁷ μοι δεδηλώσθω.
- 26 Ἐν δὲ τοῖς ἀκινδυνότεροις τοὺς ἡμίσεας τῶν προγεγραμμένων εἰς τὰς φυλακὰς καὶ περιοδίας χρὴ τετάχθαι, καὶ οὕτω τὸ ἡμισυ τῆς στρατιᾶς νύκτα ἐκάστην φυλάξει· ἀκινδύνων δὲ καὶ εἰρηναίων ὄντων ἐλάχιστά τε καὶ ἐλαχίστους τῶν ἀνθρώπων ὄχλεῖν.
- 27 καὶ ἐὰν τε περιοδείας χρὴ τῷ στρατηγῷ,⁸ σκυ-

¹ Köchly and Rüstow : ἢ ὁποτέρως M.

² Kirchhoff : σημειωθῇ M.

³ Added by Meineke.

⁴ The lacuna determined by Herm. Schöne : πάντως suggested by R. Schöne.

⁵ Diels (*Antike Technik*², 1920, 195, 1) : συμβάλλειν διαδοχῇ μερίδος M.

⁶ J. Afr. : προπελάσσεσθαι M.

⁷ Cusaubon : ἱκανός M.

⁸ Capps : τῶν στρατηγῶν M.

sentinels the warning he has received. On such occasions, while the sentinels are thus engaged, the rest of the inhabitants should be notified that after a given signal no one is to leave his house. If, however, one should go out on some necessary errand, he should take a lantern with him in order to be visible to the patrols at a distance. Moreover, no workman or artisan should work at his trade lest noises made by any persons reach the sentinels.

A plan by which the watches may be apportioned fairly and equally to all the sentinels, according as the nights become longer or shorter [has been explained . . .¹, where it was stated that the watches] should be measured by the water-clock, and this should be reset every ten days. But a better plan is to smear the interior of the clock with wax and then to remove some of the wax when the nights grow longer, so that the clock may contain more water. When, on the other hand, the nights grow shorter, more wax should be added in order that the clock's capacity may be less. Let this, then, be sufficient explanation about the equalization of the watches.

At times of less imminent peril half the men enrolled in the army should be detailed for guard or patrol duty, and in this way half the army will be on guard every night. In times of peace and security the smallest possible number of the troops should be subjected to inconvenience, and to as little as possible. And if the commander needs some

¹ A reference to some other work by the author has fallen out here, as H. Schöne saw. It was probably the *Στρατοπεδευτικὴ βίβλος* which treated of closely related topics, as one can see from Ch. xxi. 2 above.

AENEAS TACTICUS

ταλίδα ἔχουσαν σημεῖον παρὰ τοῦ στρατηγοῦ¹ παραδίδοσθαι τῷ πρώτῳ φύλακι, τοῦτον δὲ τῷ ἔχομένῳ καὶ ἕτερον ἑτέρῳ, μέχρι ἂν² περιενεχθῆ ἢ σκυταλὶς κύκλῳ τὴν πόλιν καὶ κομισθῆ παρὰ τὸν στρατηγόν· προειρηθῆσθαι δὲ τοῖς προφύλαξιν μὴ πορρωτέρῳ προενεγκεῖν τὴν σκυταλίδα τοῦ ἔχομένου φύλακος. εἰ δ' ὁ³ ἔλθων καταλάβῃ τόπον ἔρημον φύλακος, πάλιν⁴ ἀντιδιδόναι παρ' οὗ ἔλαβεν τὴν σκυταλίδα, ἢ⁵ αἰσθηταὶ ὁ στρατηγὸς καὶ γινῶ τὸν μὴ παραδεξάμενον ἀλλ' ἐκλείποντα φυλακὴν. 29 ὅς δ' ἂν φυλακῆς αὐτῷ οὔσης μὴ παρῆ εἰς τὸ τεταγμένον, ὁ λοχαγὸς αὐτοῦ παραχρῆμα τὴν φυλακὴν ἀποδόσθω, ὅποσον⁶ δᾶν⁷ εὐρίσκη, καὶ καταστησάτω ὅστις ὑπὲρ αὐτοῦ φυλάξει. ἔπειτα ὁ⁸ πρόξενος ἐξ αὐτῆς⁹ ἀποδιδόντω τῷ πριαμένῳ τὴν φυλακὴν, ὁ δὲ ταξίαρχος αὐτὸν τῇ ὑστεραίᾳ ζημιούτῳ τῇ νομιζομένῃ ζημίᾳ.

XXIII. [Ἐπέξοδος λαθραία ἐν νυκτί]

Ἐπεξόδους δὲ ποιούμενον λαθραίως ἐν νυκτὶ τοῖς προσκαθημένοις πολεμίοις τάδε προνοεῖν. πρῶτον

¹ The words παρὰ τοῦ στρατηγοῦ after σημεῖον in M seem to be a gloss (Oldfather). ² Added by Meineke.

³ Hercher: δὲ M.

⁴ Orelli: πάντ' M.

⁵ Added by Casaubon.

⁶ Hertlein: πόσον M.

⁷ Herm. Schöne (= δὴ ἂν): δ' ἂν M.

⁸ Added by Köchly and Rüstow.

⁹ Herm. Schöne: αὐτοῦ M.

¹ This passage is obscure because almost nothing is known of the method by which mercenaries were hired, but it seems most probable that agents contracted with a state to furnish a certain number, and that the agent continued to represent these men, *i.e.*, be their πρόξενος, since

patrol-work, a marked baton should be handed by him to the first sentinel; he in turn must pass it on to the next man, and one to another, until it has made the round of the city and has been returned to the commander. And previous instructions should have been given to the watchmen not to carry the baton beyond the position of the next man. If, however, a sentinel, on his arrival at a post, should find it deserted, he should return the baton to the man from whom he received it, so that the commander may be aware and may investigate which of the sentinels has failed to take the baton and has deserted his post. Whenever a man who has a turn at the watch does not report for duty, his company-commander should at once sell his position for whatever it may bring, and should put another man on guard to take his place. Then the contractor of mercenaries, the same day, should pay the money to the man who has purchased the post, and on the following day the taxiarch should impose on the contractor the customary fine.¹

XXIII. [*Secret Sallies by Night*]

One who is making secret sallies by night upon an enemy encamped outside must use caution in they would not be citizens of the city which hired them. In this case it would appear that the contractor or agent whose man had failed to do his guaranteed duty would have to pay back the fee to the one who bought the vacant position, as well as pay a fine for the failure of his man to be at his post. Where the risks of the contractor were as high as this would indicate, we may be certain that he must have counted on making a large gross profit on his original contract. The closest parallel to such a person nowadays would perhaps be the *padrone*.

AENEAS TACTICUS

μὲν φυλάξαι ὅπως μὴ τις ἐξαυτομολήσῃ¹ ἔπειτα
 φῶς ὑπαίθριον μηδὲν εἶναι, ἵνα μὴ ὁ² ὑπὲρ τῆς
 πόλεως ἀῆρ πυρωδέστερος ὢν τοῦ ἄλλου ἐκφήνη τὸ
 2 μέλλον. τοὺς τε τῶν κυνῶν ὑλαγμοὺς καὶ τῶν
 ἀλεκτρούων τὰς φωνὰς ἀφανίζειν ἄφωνα ποιοῦντα
 τόνδε τὸν καιρὸν, ἐπικαύσαντά τι³ τοῦ σώματος·
 καὶ γὰρ αἱ τούτων φωναὶ πρὸ⁴ ὄρθρου φθειγγόμενα
 3 ἐκφαίνουσι τὸ μέλλον. ἐποίησαντο δέ τινες καὶ
 τοιόνδε τεχνάσαντες. στασιασμοῦ προσποιητοῦ
 μετὰ προφάσεως εὐλόγου γενομένου⁵ παρ' αὐτοῖς,
 καιρὸν τηρήσαντες καὶ ἐπεξελθόντες ἐπέθεντο παρ'
 4 ἐλπίδα τοῖς πολεμίοις καὶ κατώρθωσαν. ἤδη δέ
 τινες τειχήρεις ὄντες καὶ ὦδε ἔλαθον ἐπεξελθόντες.⁶
 τὰς μὲν πύλας ἀπέδειμαν⁷ ὁρατῶς τοῖς πολεμίοις·
 ἧ δὲ μάλιστα εὐεπιθέτως εἶχον οἱ ἐναντίοι,⁸ ταύτη
 κατεπέτασαν ἀκάτειον⁹ καὶ ἀνήραν διὰ χρόνου τινός,
 ὥστε κατ'¹⁰ ἀρχὰς μὲν θαυμάσαι τοὺς πολεμίους,
 ὕστερον δὲ καὶ πολλάκις γιγνομένου ἀμέλειαν εἶχον.
 5 οἱ δὲ ἐν τῇ πόλει ἐν νυκτὶ διελόντες τοῦ τείχους ὅσον
 ἤθελον, καὶ ἀντιδομῆν παρασκευασάμενοι κατεπέ-
 τασαν τὸ ἰστίον. τηρήσαντες δὲ καιρὸν ἐπεξελθόν-
 τες ἐπέθεντο παραδόξως τοῖς πολεμίοις· ποιοῦντες
 δὲ ταῦτα ἐφύλασσαν μὴ τις αὐτομολήσῃ. διὸ δεῖ
 μηδὲν τῶν τοιούτων παρορᾶν. .
 6 Οὐ μὴν οὐδ' ἐν ταῖς νυξὶν ἀσκέπτως μετ' ὄχλου

¹ Casaubon: μὴ ἐξαυτομολήσῃ M: μὴ ἐξαυτομοληθῆ Herm. Schöne.

² Köchly and Rüstow: μὴθ' ὑπὲρ M.

³ C: τε M.

⁴ Added by Lange.

⁵ Casaubon: γενομενησ M.

⁶ Köchly and Rüstow: ὦδε ἐλθόντες M.

⁷ Hertlein: ἀνέδειμαν M.

⁸ Hercher: εἶχεν τοῖς ἐναντίοις M.

⁹ Kirchoff: ἀγγεῖον M.

¹⁰ Casaubon: καὶ M.

AENEAS THE TACTICIAN, XXIII. 1-6

these matters : first, to see that no one deserts, and then that there is no light burning out-of-doors, lest the air above the city, becoming more luminous than the rest, should disclose his purpose. He must suppress the howling of dogs and the crowing of cocks, making them mute for this occasion, by cautery of some part of their bodies, because their cries, uttered before daybreak, reveal what is on foot.¹ Some have used the following devices in making sallies : a pretended sedition arising among them on some specious pretext, watching an opportune moment and sallying forth they have attacked their enemies unexpectedly, and have succeeded. Others who were besieged have secretly gone out thus : They walled up the gates in sight of the enemy, but where he was most open to attack they let down a sail, which they raised after a time, so that the enemy was at first surprised, but later, when it was done many times, became indifferent. Then the residents at night broke down as much of the wall as they desired and built a false structure in its place and let the sail down over it. Then, watching the favourable moment, they sallied forth and attacked the enemy unexpectedly. But while they were doing all this they took good care to prevent any desertions. Accordingly, one must overlook none of these considerations.

Nor again should a leader inconsiderately go out

¹ Similarly Julius Africanus, *Κετροί*, 9, tells how the Parthians kept their horses from neighing by so tightly binding their tails as to rob them of their spirit by the pain which the cord inflicted. It is reported that the mules belonging to the American army in France were prevented from braying by a simple surgical operation.

AENEAS TACTICUS

ἐκπορευτέον,¹ οἷα καὶ ἐν τοῖς καιροῖς τῶν ἐπι-
 βουλευόντων τινὲς τεχνάζουσιν, οἱ μὲν ἔσω τῆς
 πόλεως οἱ δὲ καὶ ἔξωθεν, προσάγεσθαι βουλόμενοι
 τοιοῖσδε ἀπατήμασι, πυρσεύσαντές τι ἢ ἐμπρή-
 σαντες νεώριον ἢ γυμνάσιον ἢ² ἱερὸν πάνδημον ἢ
 δι' ὅπερ ἂν ἔξοδος γένοιτο πλήθους ἀνθρώπων
 καὶ οὐ τῶν τυχόντων. προνοοῦντα οὖν καὶ τὰ
 7 τοιαῦτα μὴ ἐτοιμῶς ἀποδέχεσθαι. πράξεις δὲ
 καὶ ἡδ' ἐξοισθήσεται ἐξ ἀρχόντων.³ προετοιμά-
 σαντες κατὰ τὴν χώραν θόρυβον γενέσθαι καὶ ἐκ
 τῶν ἀγρῶν εἰς τὴν πόλιν ἀγγελθῆναι κλωπῶν
 ἐπιβουλήν, δι' ὅπερ ἔμελλον οἱ πολῖται σπεύσειν εἰς
 8 βοήθειαν, γενομένου δὲ τούτου οἱ τε⁴ ἄρχοντες καὶ
 οἱ συνεθέλοντες⁵ τοὺς πολίτας⁶ παρεκάλουν εἰς
 βοήθειαν. ἐπειδὴ δ'⁷ ἠθροίσθη τὸ πλήθος τῶν
 πολιτῶν πρὸς τὰς πύλας σὺν ὄπλοις, τοιοῦδε
 9 ἐτεχνάσαντο. προεῖπον οἱ ἄρχοντες τοῖς ἠθροισμέ-
 νοις ὅτι τρία μέρη αὐτοὺς γενομένους δεῖ ἐνεδρεῦ-
 σαι μικρὸν ἀπωτέρω τῆς πόλεως, παραγγείλαντες
 ἃ προσῆκεν πρὸς τὰ μέλλοντα, τοῖς δὲ ἀκούουσιν ἦν
 10 ἀνύποπτα. καὶ τοὺς μὲν ἐξαγαγόντες ἐκάθισαν εἰς
 χωρία ἐπιτήδεια ὡς ἐνεδρεύσοντας τοῖς ἐμβεβληκόσι
 πολεμίοις· αὐτοὶ δὲ λαβόντες σώματα αὐτοῖς
 συνίστορα τῆς πράξεως προεπορεύοντο ὡς κατα-
 σκεψόμενοι⁸ τε τὰ ἀγγελλόμενα καὶ προκινδυ-
 νεύοντες⁹ τῶν ἄλλων, ἵνα δῆθεν προαγάγοιεν τοὺς
 πολεμίους εἰς τὰς ἐνέδρας ὡς ὑποφεύγοντες.
 11 πορευθέντες δὲ εἰς τόπον ὅπου ἦν αὐτοῖς ξενικὸν

¹ Casaubon: ἐκπορευταῖον M. ² Added by Orelli.

³ Köchly and Rüstow: πράξεις . . . ὡδε ξοισθήσεται ἐξ-
 αρχόντων M.

⁴ Köchly and Rüstow: γε M.

at night with a crowd, because at such times some of the conspirators are forming plots, some within, some without the city, wishing to lure one out with deceptions such as beacon-torches, setting fire to a dockyard, or a gymnasium, or a public temple, or some building on account of which a crowd of men—and influential men too—might rush out. A leader should, therefore, use foresight, and not readily accept at their face value even such incidents. I shall relate also the following sharp practice on the part of officials. It was arranged that a disturbance should arise in the country, and that word should be brought from the fields to the city of a robbers' plot, of the very kind at which the citizens were sure to hurry to the rescue. And when this occurred, the magistrates and their supporters summoned the citizens to the rescue, and when the full number of the townsmen was gathered at the gates under arms, they contrived as follows. The magistrates told the crowd that they must divide into three parts and lay an ambush a little distance from the city, and explained what they must do, the hearers having no suspicion of the truth. They then led the people forth and stationed them in suitable places as though to ambush the invading enemy, while they themselves, taking troops who were accomplices in the matter, went ahead as though to inquire into the report and meet the danger first, ostensibly in order to entice the enemy into the ambuscades by pretending to flee. But going to a place where they had a

⁵ Köchly and Rüstow: *συνελθοντες* M.

⁶ Casaubon: *πολεμικου* M. ⁷ Added by Herm. Schöne.

⁸ Casaubon: *κατακοφόμενοι τε* M.

⁹ Hertlein: *προκινδυνεύοντες* M.

AENEAS TACTICUS

προητομασμένον κρυφαίως¹ κοιμισθέντες² κατὰ θάλατταν, ἀναλαβόντες ἔφθασαν καὶ ἔλαθον εἰσαγαγόντες εἰς τὴν πόλιν κατ' ἄλλας ὁδοὺς, ὡς τοὺς ἐπεξελθόντας πολίτας πάλιν ἀπαγαγόντες· τὴν δὲ πόλιν καταλαβόντες τοῖς ξένοις τῶν ἐν ταῖς ἐνέδραις ὄντων τοὺς μὲν ἐφυγάδευον, τοὺς δὲ ἐδέχοντο. διὸ δεῖ πάντα τὰ τοιαῦτα ὑποπτεῦειν καὶ μὴ ἀλογίστως νύκτωρ εἰς πολεμίους ἕξοδον πλήθους ποιεῖσθαι.

XXIV. [Συνθημάτων³]

Παραδιδόντα δὲ συνθήματα δεῖ προνοεῖν, εἰὰ τύχη τὸ στράτευμα μιγάδες ὄντες ἀπὸ πόλεων ἢ ἐθνῶν, ὅπως μὴ, ἂν παρέχη τὸ ἐν εἶδος δύο ὀνόματα, ἀμφιβόλως παραδοθήσεται, οἷον τάδε, Διόσκουροι Τυνδαρίδαι, περὶ ἐνὸς εἶδους δύο ὀνόματα οὐ τὰ
² αὐτά· καὶ ἄλλοτε δὲ Ἄρης Ἐνυάλιος, Ἀθηνᾶ Παλλάς, ξίφος ἐγχειρίδιον, λαμπὰς φῶς, καὶ ἄλλα ὁμότροπα τούτοις, ἅπερ δυσμνημόνευτά ἐστιν παρὰ τὰ νομιζόμενα ἐκάστῳ ἔθνει⁴ τῶν ἀνθρώπων καὶ βλάβην φέρει, εἰὰ κατὰ γλώσσάν τις παραγγέλλη
³ μᾶλλον⁵ ἢ κοινόν τι ἅπασιν. ἐν μιγάσι δ' οὖν ξένοις οὐ δεῖ τὰ τοιαῦτα παραγγέλλειν, οὐδὲ ἐν ἔθνεσι συμμάχοις. οἷον Χαριδήμῳ Ὠρείτῃ περὶ τὴν Αἰολίδα συνέβη, καταλαβόντι Ἴλιον τρόπῳ
⁴ τοιῶδε. τῷ ἄρχοντι τοῦ Ἰλίου ἦν οἰκέτης ἐκπορευόμενος ἐπὶ λείαν αἰεί, καὶ μάλιστα ἐν ταῖς νυξίν

¹ Casaubon: κρύψαι ὡς M. ² C (AB?): κοιμισθέντες M.

³ περὶ σ. suggested by R. Schöne: σ. παράδοσις by Herm. Schöne

⁴ Casaubon: ἔθει M: ἔθη Hercher.

⁵ Added by R. Schöne after Haase

mercenary force, previously arranged and secretly brought in by sea, they picked them up before any one knew of it, and secretly entered the city by other roads, as though returning with the citizens who had gone out for the attack. Then, with the mercenary force, they occupied the city, and of those in the ambuscades they banished some and admitted others. Accordingly, one must be suspicious of such acts and not inconsiderately make a sally in force at night against an enemy.

XXIV. [*Of Watchwords*]

In giving out watchwords it is needful to provide, if the army happen to be a mixture from different cities or tribes, that the word shall not be given out in an ambiguous way, in case one concept may have two different names, as for example, *Dioscuri* and *Tyndaridae*, two dissimilar words for one concept; or, again, *Ares*, *Enyalios*; *Athena*, *Pallas*; *sword*, *dagger*; *torch*, *light*; and others like these; for they are hard to remember if contrary to the custom of the several tribes, and they cause harm if one issues a password in dialect instead of in language common to all. One should not, then, issue such words to mixed mercenaries nor to allies of different tribes. Such a thing happened to Charidemus of Oreus in Aeolis when he had taken Ilium¹ as follows. A slave of the commander of Ilium went out for booty from time to time, and particularly at night

¹ This happened in 360 B.C. and is the latest event to which Aeneas makes reference. An account varying in some minor details is given by Polyænus iii. 14. Thus, for a second time, as Polyænus remarks, was Ilium captured by the use of a horse.

AENEAS TACTICUS

ἔξεπορεύετο καὶ εἰσεπορεύετο εἰσάγων¹ τὰ ἀγρευ-
 5 θέντα ἐκάστοτε. ἐν δὲ τῷ χρόνῳ τούτῳ κατα-
 μαβῶν ὁ Χαριδίημος ταῦτα πράσσοντα οἰκειοῦται,
 καὶ εἰς λόγους κρυφαίους ἀφικόμενος διομολογεῖται,
 καὶ ἔπεισεν αὐτὸν ἐκπορευθῆναι ἐν ῥητῇ νυκτὶ ὡς
 ἐπὶ λείαν· μεθ' ἵππου δὲ ἐκέλευσεν αὐτὸν ἐξελθεῖν
 ἐν τῇ νυκτί, ἵνα αἱ πύλαι αὐτῷ ἀνοιχθεῖεν, ἀλλὰ μὴ
 κατὰ τὴν διάδυσιν² ἢ τὴν ἐκτομάδα πυλίδα ὡσπερ
 6 εἰώθει,³ εἰσελθοί. γενόμενος δ' ἔξω καὶ διαλεχ-
 θεὶς τῷ Χαριδίημῳ ἔλαβεν παρ' αὐτῶν ξένους ὡς
 τριάκοντα τεθωρακισμένους καὶ ἔχοντας ἐγχειρίδια
 7 καὶ ὄπλα καὶ περικεφαλαίας κρυφαίας.⁴ ὡς
 ἀπήγαγόν τε οὖν αὐτοὺς ἐν τῇ νυκτὶ ἐν ἐσθῆτι
 φαύλῃ καὶ ἔκρυψε τὰ ὄπλα, καὶ ὁμοιώσας αἰχμαλώ-
 τοις, μετ' ἄλλων γυναικῶν καὶ παιδαρίων, καὶ
 τούτων ὡς αἰχμαλώτων, εἰσεπορεύετο ἀνοιχθεισῶν
 8 αὐτῷ τῶν πυλῶν διὰ τὸν ἵππον. ὅπου δὴ εὐθύς οἱ
 εἰσελθόντες ἔργου εἶχοντο τὸν τε πυλωρὸν ἀποκτεί-
 ναντες καὶ εἰς ἄλλας ξένας πράξεις ὀρμήσαντες, καὶ
 τῶν πυλῶν ἐγκρατεῖς ὄντες, ἐφ' ἃς εὐθύς, οὐ πόρρω
 ὄντος τοῦ Χαριδίημου, παρήσαν τάξεις καὶ κατ-
 9 ἔλαβον τὸ πόλισμα. μετὰ δὲ ταῦτα καὶ αὐτὸς
 εἰσεπορεύθη μετὰ πάσης τῆς δυνάμεως. ἅμα δὲ
 10 τούτοις καὶ τοιονδ' ἔπραξεν. τοῦ στρατεύματός
 τινι μέρει ἐνέδρας ἐποιήσατο, προνοήσας ὅτι
 παρέσοιτο βοήθεια ἐπὶ τὸ χωρίον. ὅπερ συνέβη·
 εὐθύς γὰρ αἰσθόμενος Ἀθηνόδωρος Ἴμβριος, ὃν οὐ
 πόρρω μετὰ στρατεύματος, ἐπειράτο βοηθεῖν ἐπὶ τὸ
 11 χωρίον. ἔτυχε δὲ καὶ αὐτὸς ἀγχίνως⁵ πάλιν ἀνθ-
 υποπτεύσας,⁶ καὶ οὐ τὰς ἐνεδρευομένας ὁδοὺς
 ἐπορεύθη πρὸς τὸ Ἴλιον, ἀλλὰ ἄλλας πορευθεὶς

¹ Casaubon: εἰσάγων M.

² Hertlein: διάδυσιν M.

used to go out and come in with what he had on each occasion taken. At this time Charidemus learned that he was engaged in this business and made a friend of him. At a secret conference an agreement was made, and Charidemus induced him to go out on a given night as though for booty, bidding him leave on horseback, after nightfall, that the gates might be opened for him, but not to re-enter by the passage or the wicket-gate as he was accustomed. When he was outside and talking with Charidemus he received from him about thirty mercenaries secretly provided with breastplates, swords, weapons, and helmets. So he led them off in the dark, in mean garb and with arms concealed, disguising them as captives, in company with others, women and children, these too apparently captives, and entered the city through the gate which was opened for him because of his horse. There, immediately upon their entrance, they set to work, killing the gate-keeper and doing other barbarous acts. Charidemus was near the gates of which they kept control, and his troops immediately went in and took the town. Then he entered in person with all his forces. At the same time he carried out such a scheme as this, also: He laid an ambush with a part of his army, foreseeing that aid would come to the place, as actually happened. For Athenodorus, the Imbrian, who was not far away with his army, as soon as he learned the news, set out to succour the place. He too seems shrewdly to have had his suspicions and marched unobserved during the night to Ilium, not by the

³ Casaubon: ελώθη M.

⁴ Casaubon: κορυφαίας M.

⁵ C?: βαγγίως MAB.

⁶ Casaubon: πάλιν ἄν (space) ὑποπτεύσας M.

AENEAS TACTICUS

- ἔλαθ' ἐν τῇ νυκτὶ καὶ ἦλθεν πρὸς τὰς πύλας.
 12 καὶ ἔλαθόν τινες συνεισελθόντες¹ εἰς τὴν πόλιν ἐν τῷ θορύβῳ, ὡς τοῦ Χαριδήμου ὄντες στρατεύματος.
 13 ἔπειτα πρὸ τοῦ πλείονα² εἰσελθεῖν ἐγνώσθησαν τῷ συνθήματι, καὶ οἱ μὲν ἐξέπεσον αὐτῶν, οἱ δὲ καὶ περὶ τὰς πύλας διεφθάρησαν· τοῖς μὲν γὰρ ἦν τὸ
 14 σύνθημα Τυνδαρίδαι, τοῦ³ δὲ Διόσκουροι. καὶ παρὰ τοῦτο ἐγένετο τὴν⁴ πόλιν μὴ ἀντικαταληφθῆναι παραχρῆμα ὑπὸ τοῦ Ἀθηνοδώρου ἐν τῇ αὐτῇ νυκτὶ. παραγγέλλειν οὖν χρὴ τὰ συνθήματα εὐμνημόνευτά τε καὶ ὡς μάλιστα⁵ ἀδελφὰ ταῖς
 15 μελλούσαις πράξεσι γίνεσθαι, οἷον τάδε. ἐπὶ μὲν ἄγραν πορευομένοις⁶ Ἄρτεμιον Ἀγροτέραν, ἐπὶ δὲ κλοπὴν τινα πράξεων Ἑρμῆν Δόλιον, ἐπὶ δὲ βιασμόν⁷ Ἡρακλέα, τοῖς δὲ φανεροῖς ἐγχειρήμασι Ἥλιον καὶ Σελήνην, καὶ ὡς μάλιστα ὁμότροπα
 16 τούτοις καὶ κοινότατα πᾶσιν. Ἴφικράτης δὲ οὐδὲ τὸ⁸ αὐτὸ σύνθημα ἐκέλευεν τὸν⁹ περίοδόν τε καὶ φύλακα¹⁰ ἔχειν, ἀλλὰ ἕτερον ἑτέρῳ δεδόσθαι, ἵνα ὁ μὲν τὸ πρῶτον ἐρωτηθεὶς ἀποκρίνηται Ζεὺς Σωτήρ, εἰάν τοῦτο ἔχων τύχῃ, ὁ δ' ἀντερωτηθεὶς¹¹ Ποσειδῶν. οὕτω γὰρ ἂν ἤκιστα σφάλλοιτο ὑπὸ τῶν πολεμίων

¹ Köchly and Rüstow: *συνελθόντες* M.

² Casaubon: *πλείονος* M.

³ τοῖς Casaubon: *τῷ* suggested by R. Schöne.

⁴ Added by Hercher.

⁵ Köchly and Rüstow: *μάλιστα* ὡς M.

⁶ Köchly and Rüstow: *πορευόμενος* M.

⁷ Casaubon: *βιασμών* M.

⁸ Added by Casaubon.

⁹ Casaubon: *τὴν* M.

¹⁰ Casaubon suggested τὸν *προφύλακα*, comparing § 19.

¹¹ Casaubon: *ἀν ἐρωτηθεῖς* M.

AENEAS THE TACTICIAN, xxiv. 11 - 16

roads which were ambushed but by other routes, and came to the gates. In the confusion, some of his troops went into the city with the others without being noticed, as though they belonged to the army of Charidemus. Then before many of them had entered they were detected by their countersign, and some were expelled and some killed at the gates, for their countersign was *Tyndaridae* while that of Charidemus was *Dioscuri*. By so narrow a margin it was that the city was not recaptured at once, that same night, by Athenodorus. So it is important to issue watchwords easily remembered and as nearly related as possible to the intended operations. For instance, when going for game, *Artemis the Huntress*; for some stealthy enterprise, *Hermes the Trickster*; for some deed of violence, *Heracles*; for open undertakings, *Sun and Moon*; and others as similar as possible to these and quite comprehensible to all. Iphicrates¹ would not allow the same watchword to be issued to the patrol and the guard, but employed a different word for each, that the one first questioned might reply, *Zeus the Saviour*, if he happened to have this one, and the other *Poseidon*. For in this manner they would be least

¹ Probably the greatest tactician whom Greece produced. He was active from about 395 to 355 B.C. Numerous stratagems are ascribed to him, and a large number of new weapons and pieces of equipment, the best known being, perhaps, the *Iphicratides*, or marching shoes. He developed the use of light-armed men, the peltasts, and was the first to introduce the constantly fortified camp. It was to these two features of their tactics that the Romans owed most of their military supremacy, and as the development of their military organization followed soon after the time of Iphicrates, it is tempting to think that they took these two epoch-making ideas from him.

AENEAS TACTICUS

- 17 καὶ ἔξαντομολοῖτο τὸ σύνθημα. πλάνης δὲ γενομένης τοῖς φύλαξι ἀπ' ἀλλήλων συριγμῶ χρήσθαι πρὸς αὐτούς, τοῦτον¹ δὲ προσυγκεῖσθαι· πλὴν γὰρ τῷ εἰδότει ἄγνωστος² τοῖς ἄλλοις ἔσται, εἴαν τε
- 18 Ἕλληνες εἴαν τε βάρβαροι ὦσιν. προενθυμεῖν δὲ τῶν κυνῶν, μὴ διὰ τὸν συριγμὸν ἀσύμφορον ἐξ αὐτῶν ἦ. ἐχρήσαντο δὲ αὐτῷ καὶ ἐν Θήβαις ὅτε τὴν Καδμείαν καταλαβόντες ἐσκεδάσθησαν νυκτὸς καὶ ἠγνόησαν ἀλλήλους, πρὸς συριγμὸν δὲ συνελέ-
- 19 γοντο.³ τὰ δὲ συνθήματα ἐρωτᾶσθαι κοινῶς τοῖς τε περιοδεύουσι καὶ προφύλαξι· οὐδὲν γὰρ προσήκει τὸν ἕτερον ἐρωτᾶν. ὡς⁴ γὰρ περίοδος καὶ πολέμιος ἂν ἐρωτῶη.⁵

XXV. [Παρασυνθήματα]

Ἔνιοι δὲ παρασυνθήμασι⁶ χρῶνται τῶν τε πανείων ἕνεκεν καὶ πρὸς τὸ γνωρίζειν μᾶλλον τοὺς φίλους. εἶναι δὲ καὶ παρασυνθήματα ὡς ἰδιαίτατα καὶ δυσγνωστότατα τοῖς πολεμίοις. εἶη δ' ἂν τὰ παρασυνθήματα τοιάδε. ἐν μὲν ταῖς σκοτειναῖς νυξίν τό τε σύνθημα ἐρωτᾶν καὶ φωνεῖν τι, μᾶλλον δὲ⁷ καὶ ψόφον⁸ ἐμφανίσαι, τὸν δὲ ἐρωτῶμενον τό τε σύνθημα ἀποκρίνεσθαι καὶ ἄλλο τι⁹ προσυγκείμενον φωνῆσαι ἢ ψόφον ἐμφανίσαι· ἐν δὲ τοῖς

¹ Hercher: αὐτούς, τούτο M.

² Hercher: ἄγνωστον M.

³ Meineke: ἑαυτοῖς πρὸς συριγμὸν συνελέγοντο M.

⁴ Casaubon: ὁ M.

⁵ Casaubon: ἀνερωτῶν M.

⁶ Kochly and Rüstow: παρασυνθήματι M.

⁷ Added by R. Schone.

⁸ Casaubon: ψῆφον M.

⁹ Hercher: ἄλλω M.

likely to be deceived by the enemy, and the watchword to be betrayed. If the guards become separated from one another they should give a whistle agreed upon beforehand to call one another. For, except to the man who already knows it, this signal will be unfamiliar, as well to Greeks as to barbarians. One should watch the dogs lest on account of the whistling there be some trouble from them. This method was used at Thebes when the Cadmea was captured: the forces were scattered in the darkness and unable to recognize one another, but were collected by whistling.¹ The watchwords should be asked by the men on patrol and the advanced pickets, each from the other, for there is no propriety in having only the one do the asking, since in the guise of a patrol even an enemy might do that.

XXV. [*Additional Tokens of Recognition*]

Some employ an additional token of recognition, both to prevent panics and the better to recognize their friends. Additional tokens of recognition must be as distinctive and as difficult as possible for the enemy to understand. They may be as follows. On dark nights ask the watchword and say something else, or rather also make a noise, and the one questioned must in reply give the watchword and utter some other word or make a noise, according to previous agreement. Again, when it

¹ This was probably the recapture of the Cadmea from the oligarchs and the Spartans in 379 B.C., rather than the original capture in 383. The reference in Ch. xxxi. 34 doubtless points to the former.

AENEAS TACTICUS

φαινοῖς χρόνοις τὸν μὲν ἐρωτῶντα τὸ σύνθημα τὸν
 πῖλον ἀφελῆσθαι ἢ ἐν τῇ χειρὶ ἔχοντα ἐπιθέσθαι,
 3 ἔστιν δὲ καὶ ἐπαγαγῆσθαι τὸν πῖλον ἐπὶ τὸ πρόσω-
 4 πον καὶ ἀπαγαγῆσθαι ἀπὸ τοῦ προσώπου, ἔτι δὲ
 καὶ τὸ δόρυ καταπῆξαι προσιόντα ἢ εἰς τὴν ἀριστερὰν
 παραλαβεῖν, ἢ¹ ἔχειν ἐν τῇ χειρὶ ἄραυτα ἢ ἀνελέσθαι,
 τὸν δὲ ἐρωτώμενον τό τε σύνθημα ἀποκρίνασθαι
 καὶ τούτων τι προσυγκείμενον ποιῆσαι.

XXVI. [Περιοδεῖαι]

Περιοδεύειν μὲν² ἐν τοῖς κινδύνοις πρῶτον³ τῶν
 ἐν τῇ ἀγορᾷ ἠθροισμένων λόχων δύο ὑπὸ τὸ τεῖχος
 ἐναλλάξ ἀλλήλοις, διεσκευασμένους τοῖς ὑπάρχουσιν
 ὄπλοις καὶ παρασυνθήμασιν,⁴ ὡς ἀκριβῶς ἐκ
 2 πλείονος διαγινῶναι ἑαυτούς. τοὺς δὲ τὴν πρώτην
 φυλακὴν περιοδεύοντας ἀδείπνους χρήν περιοδεύειν·
 τυγχάνουσι γὰρ οἱ τὴν πρώτην προφυλάσσοντες ἀπὸ
 δειπνοῦ ὄντες⁵ ῥαθυμοτέρως τε καὶ ἀκολαστοτέρως
 3 διακείμενοι. περιοδεύειν δὲ ἄνευ λαμπτήρος, ἂν
 μὴ λίαν χειμῶν ἦ⁶ καὶ σκότος· εἰ δὲ μή, οὕτω ὁ
 λαμπτήρ φεγγέτω, εἰς ὕψος μὲν μηδέν (κεκαλύφθω
 γάρ τι), ἐπὶ δὲ τὴν γῆν καὶ τὰ πρὸ τῶν ποδῶν⁷
 4 μόνον φεγγέτω. ἐν ἵπποτροφοῦσιν δὲ πόλει καὶ ἐν
 ἵππασίμῳ χειμῶνος ἵππεῦσι περιοδεύειν· ἐν γὰρ
 τοῖς ψύχεσιν καὶ πηλοῖς⁸ καὶ μήκεσι τῶν νυκτῶν
 5 θᾶσσον ἀνύοιτ' ἂν ἡ περιοδεῖα. εἰ δὲ ἅμα τούτοις

¹ Herm. Schöne suggests λίθον after ἦ, comparing xxvi. 6.

² Added by Herm. Schöne.

³ Herm. Schöne: πρῶτον δὲ M.

⁴ Casaubon: παρασύνθημα M.
 Casaubon: οτιοδειπνονοτος M.

is light, the person asking the watchword may remove his cap, or, if he holds it in his hand, may put it on, or he may also bring his cap to his face and take it away from his face, or, further, may advance and fix his spear, or transfer it to his left hand, or hold it aloft in his hand, or merely raise it; and the person who is asked for the watchword must both reply and do whichever of these actions has been agreed upon.

XXVI. [*Patrols*]

In times of danger the first thing is for two of the companies assembled in the market-place to patrol alternately at the base of the wall, provided with the arms available and with tokens of recognition so as to recognize one another with certainty from a considerable distance. And those who patrol during the first watch must do so before they have had their supper, for those who are on guard during the first watch, if they have just eaten, are more careless and undisciplined. And they should patrol without a light, unless it be very stormy and dark. But if they have a light it must not shine upward (for it must be covered with something), but merely upon the ground and in front of their feet. In a town in which horses can be kept and on ground passable for them patrolling can be done in winter by horsemen, for in the cold and mud and long nights the patrolling would thus be more quickly accomplished.

⁶ Casaubon: ἦ M.

⁷ Casaubon: διπῶν M (with indication of corruption over π).

⁸ Orclli: δηλοισ M.

AENEAS TACTICUS

καὶ ἐπὶ τοῦ τείχους περιδεύωσι, . . .¹ ὥστε τινὰς μὲν τὰ² ἔξω τοῦ τείχους ἐπισκοπεῖσθαι, τινὰς δὲ 6 βὰ ἔσω· ἔχειν δὲ καὶ περιδεύοντας λίθους ἐν ταῖς σκοτειναῖς νυξὶ καὶ βάλλειν ἄλλην καὶ ἄλλην εἰς τὸ ἔξω μέρος τοῦ τείχους. οἱ δὲ οὐκ ἐπαινοῦσι τοῦτο 7 διὰ τὰ προγεγραμμένα. ἐν ὑποψία ὄντων ἀλλήλοισι . . .³ χρῆ δὲ τὰς περιδείας εἶναι κάτω τοῦ τείχους, καὶ μὴ ἀναβαίνειν τοὺς⁴ περιόδους πλὴν τῶν φυλάκων.

Καὶ ἐὰν στράτευμα κεκακοπαθήκη⁵ μάχῃ λειφθέν,⁶ ἢ διὰ τὸ πλῆθος ἀποβαλεῖν νεκρῶν ἢ τραυματιῶν,⁷ ἢ συμμάχων ἀποστάσει ἢ δι' ἄλλο τι σύμπτωμα ἀθυμῆ⁸ καὶ τεταπεινωμένον ἢ,⁹ ἐπικίνδυνά τε ἢ¹⁰ πολεμίων ἐγγὺς ὄντων, χρῆ τὰ προγε- 8 γραμμένα κατὰ τὰς φυλακὰς πράσσειν. καὶ τὰς περιόδους ἐν τοῖς τοιούτοις καιροῖς πυκνάς τε χρῆ περιδεύειν καὶ οὐ δεῖ προθυμεῖσθαι ἐν ταῖς περιδείαις εὐρίσκειν τινὰς τῶν προφυλασσόντων ἀμελεστέρως διακειμένους διὰ ὕπνον ἢ κάματον· οὐ γὰρ συμφέρεи οὕτω διακείμενον τὸ στράτευμα ἔτι ἀθυμότερον καθιστάναι (εἰκὸς δὲ ὅταν εὐρεθῆ 9 αἰσχρόν τι ποιῶν ἀθυμεῖν), ἀλλὰ μᾶλλον πρὸς θεραπείαν τε καὶ ἀνάληψιν αὐτῶν¹¹ τραπέσθαι. καὶ περιόδους ἐν τοῖς τοιούτοις καιροῖς ἐκ πλείονος χωρίου καταδήλους εἶναι προσιόντας τοῖς φύλαξι

¹ R. Schöne places a lacuna here for which he suggests τούτους οὕτω τετάχθαι.

² Hercher: εἰς τὰ M.

³ R. Schöne places a lacuna here (space of three letters in M) in which he supposes that some prescription beginning χρῆ μὲν . . . to balance χρῆ δὲ stood.

⁴ Casaubon: τὰς M.

⁵ Köchly and Rüstow: κεκακοπάθηκεν M.

⁶ Casaubon: ληφθέν M.

AENEAS THE TACTICIAN, xxvi. 5-9

And if together with these some men also patrol upon the walls [they should be so placed] that some may watch the outside of the wall and some the inside. They should also on dark nights as they make their rounds have stones and throw them now and then outside the wall. Some, however, do not approve this custom for the reasons already mentioned.¹ In case they are suspicious of one another . . . the patrolling should be done at the base of the wall and no patrol except the watchmen should go up on the wall.

Now if an army has suffered in morale because of defeat in battle, or from the size of their losses in dead and wounded, or from desertion by allies, or through any other misfortune it loses heart and has become discouraged, and if there is danger because of the nearness of the enemy, the directions already given in regard to the watchmen are to be carried out. At such times frequent rounds are necessary, but the patrol must not be too eager on his rounds to find members of the outposts in a rather careless condition from sleep or weariness. For it is not expedient to make the army, when in this state, still more disheartened—and a man is naturally discouraged if he is found behaving basely—but rather to turn one's attention to the care and recovery of one's troops. And at such times the approach of the patrols should be evident to the guards from

¹ The reference is to Ch. xxii. 13.

⁷ R. Schöne: ἀποβαλεῖν ἢ τραυμάτων M.

⁸ Casaubon: ἀθινμεί M.

⁹ Casaubon: ἢ M.

¹⁰ Casaubon: ἢ M.

¹¹ R. Schöne: αὐτῶν M.

AENEAS TACTICUS

- φωνοῦντάς τι πόρρωθεν, ὅπως ἀνεγερθῆ¹ ἐὰν καθεύδη ὁ προφύλαξ καὶ παρασκευάσεται ἀπο-
 10 κρίνεσθαι τὸ ἐρωτώμενον. ἄριστον δὲ αὐτὸν τὸν στρατηγὸν ἐν τοῖς τοιούτοις καιροῖς ἐπιμελῶς ἐκάστην² περιοδεύειν μετὰ τῶν αὐτῶν ἀπολέκτων³ ἀνδρῶν. ὑπεναντίως⁴ δὲ τούτοις διακειμένον στρατεύματος ἐπισπερχεστέρωσ τοὺς φύλακας ἐξετά-
 11 ζειν. ἐφοδεύειν τε τὸν στρατηγὸν μηδέποτε τὴν αὐτὴν ὥραν ἀλλ' αἰεὶ διαλλάσσοντα,⁵ ἵνα μὴ προειδότες⁶ σαφῶς ἐκ πολλοῦ χρόνου τὴν ἀφίξιν τοῦ στρατηγοῦ οἱ στρατιῶται ταύτην⁷ μάλιστα τὴν ὥραν φυλάσσωσιν.
- 12 Ἀποδέχονται δὲ τινες καὶ τόδε ἐπαγγελλομένων τινῶν καὶ κελευόντων. τὸν πολίταρχον, ἐὰν μὴ θέλῃ περιοδεύειν διὰ κόπον⁸ τινὰ ἢ ἀρρωστίαν, θέλῃ δὲ εἰδέναι τὸν μὴ φυλάσσοντα καθ' ἐκάστην
 13 φυλακὴν, τάδε ποιεῖν χρή· λαμπτήρας εἶναι προσυγκείμενον ἔστω⁹ πᾶσι τοῖς ἐπὶ τῷ τείχει φύλαξιν καὶ ἓνα¹⁰ πρὸς ὃν πάντες ἀνταροῦσιν¹¹ οἱ προφύλακες· αἰρέσθω δὲ ἐκ τόπου ὅθεν πάντες
 14 ὄψονται οἱ ἐπὶ τοῦ τείχους φύλακες. ἐὰν δὲ μὴ ὑπάρχη ὁ τοιοῦτος τόπος, παρασκευασθήτω ἕκ τινων ὕψος ὡς μέγιστον. ἔπειτα ἀπὸ τούτου αἰρέσθω λαμπτήρ, καὶ πρὸς τοῦτον ἀνταίρεσθαι τοὺς ἄλλους καθ' ἓνα ἕκαστον ἀφ' ἐκάστου φυλα-

¹ Meineke: ἀν ἐγερθῆ M. ² Herm. Schöne: ἕκαστον M.

³ Casaubon: ἀποδεκτων M. ⁴ Casaubon: ὑπεναντίοισ M.

⁵ Mor. Haupt: ἀλλὰ ἰδία λαμβάνοντα M.

⁶ Köchly and Rüstow: προῖδόντες M.

ταύτην Ταύτην M. ⁸ Meineke: φόβον M.

⁹ Added by Meineke.

¹⁰ Added by Köchly and Rüstow (εἰς Casaubon).

¹¹ Meineke: ἀνταίρουσιν M.

AENEAS THE TACTICIAN, xxvi. 9 - 14

a long way off by their uttering some sound from a distance, so that the guard may be wakened if he is sleeping, and may be prepared to answer whatever is asked. It is best of all at such times for the general himself carefully to make each circuit with the same picked men. But when the army is in the opposite mood it is well to inspect the guards much more energetically. The general must never make his round at a fixed hour, but must constantly shift it, lest the soldiers, knowing definitely long beforehand the coming of the general, may watch with especial care during that time.

At the advice and bidding of certain persons, however, some men adopt the following plan. If the commander of the city,¹ on account of some weariness or ill-health, does not wish to go on patrols, yet desires to know who, in each watch, fails to keep guard, he should act as follows. Let it be previously arranged that all the watchmen at the wall shall be supplied with lanterns, and that there shall be a particular one at the appearance of which all the watchmen shall raise theirs. This one should be raised from a place at which all the watchmen on the wall will see it, but if there be no such place ready, let one be built somehow, as high as possible. Then from the top of this let a lantern be raised and at its appearance let the others be raised, one by one, from each several post. Then

¹ The rare word *πολιταρχος* occurs elsewhere (*e.g.*, *Acts of the Apostles* xvii. 6 and 8, in the form *πολιτάρχης*; *CIG.* ii. 1967; Dittenberger, *Sylloge*³ 700. 2 and 48, *cf.* note 3) almost exclusively at Thessalonica (Saloniki) and the vicinity. It is not improbable that Aeneas got the term from there, as it appears that he saw military service at one time or another in the north Aegean.

AENEAS TACTICUS

κειου. ἔπειτα ἀριθμῆσθαι, καὶ οὕτως εἶδέναι εἰ πάντες ἦσαν οἱ προφύλακες ἢ ἐκλείπει τις τῶν φυλάκων.

XXVII. [Πανείων¹]

Τοὺς δὲ περὶ πόλιν ἢ στρατόπεδα ἐξαίφνης θορύβους καὶ φόβους γενομένους νυκτὸς ἢ μεθ' ἡμέραν, ἅπερ ὑπὸ τινων καλεῖται πάνεια (ἔστιν δὲ τὸ ὄνομα Πελοποννήσιον² καὶ μάλιστα Ἄρκαδικόν), πρὸς³ ταῦτ' οὖν τινες κελεύουσι, καταπαύειν⁴ θέλοντες αὐτά, προσυγκεῖσθαι τοῖς ἐν τῇ πόλει σημεῖα, ἃ⁵ ἰδόντες γινώσκονται· γινώσκονται⁶ δὲ ὅτι ἔστιν πάνειον ὧδε· αἰσθήσονται διὰ⁷ πυρός τι προσυγκείμενον ἐπὶ χώρου εὐκατόπτου⁸ πᾶσιν εἰς δύναμιν τοῖς ἐν τῇ πόλει. ἄριστον δὲ προπαρηγγέλθαι, καθ' οὓς ἂν τῶν στρατιωτῶν γένηται φόβος, κατὰ χώραν τε ἡρεμεῖν καὶ ἀναβοᾶν παιᾶνα, ἢ λέγειν ὅτι εἶη πάνειον⁹ καὶ τὸν ἀκούοντα⁴ αἰεὶ τῷ πλησίον¹⁰ παραγγέλλειν. καθ' οὓς ἂν τοῦ στρατεύματος μὴ ἀντιπαιανίζωσιν,¹¹ εἶδέναι

¹ περὶ πανείων οἱ πανείων κατάπανσις suggested by R. Schöne.

² Casaubon: πελοποννήσιον M.

³ Added by Herm. Schöne.

⁴ C: καταπάνειν M.

⁵ Haase: δ' M.

⁶ αἰσθήσονται Hunter.

⁷ Herm. Schöne: πάνειον· ἔστω δὲ αἰσθήσονται πυρός M: ἔστω δὲ πυρός Hunter.

⁸ Köchly and Rüstow: ἐκκατόπτου M.

⁹ λέγειν τὸ ἰθὺ παιῆον Herm. Schöne.

¹⁰ C: τὸν πλησίον M.

¹¹ Meier: ἀντιπαιανίζουσιν M.

¹ Groundless fear, called 'panic' fear, was ascribed to the mysterious Arcadian mountain god, Pan. Greek armies seem to have been peculiarly subject to these panics, due, doubtless, to the rather indifferent discipline which generally prevailed.

they should be counted, and thus it may be known whether all the watchmen have raised them, or if any one of the guards is missing.

XXVII. [*Of Panics*]

The confusions and terrors that suddenly arise in a city or a camp, by night or by day, are by some called *panics*—the word is a Peloponnesian, particularly an Arcadian one.¹ Accordingly, against these some who wish to stop them advise that signals be appointed in advance for all the inhabitants of the town, which they will see and recognize, and in the following way they will know that there is a panic, namely, by noticing a previously arranged signal-fire at a place as conspicuous as may be to all those in the city. And it is best to announce beforehand that, wherever panic occurs among the soldiers, they should stand in their places and shout 'Paeon,'² or say that it is a mere panic, and that every one who hears it should pass the word along to his neighbour. Now wherever in the army they do not answer the paeon, it will be known that there the terror pre-

¹ Paeon was a very ancient god of healing among the Greeks, who later came to be identified with Apollo, Asclepius, and others. He was called upon with the cry *ἰη Παιῶν* or *ἰηε Παιῶν* to cure an evil or avert a misfortune. Out of this custom developed a song in honour generally of Apollo as god of healing, with the refrain *ἰη Παιῶν*. A paeon, or solemn hymn with the refrain *ἰη Παιῶν*, was commonly sung before entering battle, but it is likely that a mere invocation of the god is here intended. (A. Fairbanks, in his exhaustive work on the Greek Paeon, *Cornell Studies in Class. Philol.* xii, seems to have overlooked this passage in Aeneas.)

AENEAS TACTICUS

- κατὰ τούτους τὸν φόβον ὄντα. εἰ δέ τι ὁ στρατηγὸς φοβερὸν αἰσθηται, τῇ σάλπιγγι σημαίνειν· τοῦτο δ' ἔστω γνωστὸν ὅτι εἶη τὸ πολέμιον. μάχης δὲ γενομένης καὶ νικηθέντων ὡς τὰ πολλὰ γίνονται φόβοι, ἐνίοτε μὲν καὶ ἡμέρας, καὶ 5 νυκτὸς δὲ καὶ πάνυ. ὡς δὲ¹ οὖν ἦσσόν τι² τοιοῦτον γενέσθαι, χρή εἰς τὴν νύκτα παρηγγέλθαι τοῖς στρατιώταις πᾶσι κατὰ τὰ ὄπλα εἶναι ὡς 6 μάλιστα, ὡς ἐσόμενόν τι περὶ αὐτοῦς. προειδότας οὖν εἰκὸς ἐστίν,³ εἰάν τι γίνηται, μὴ ἀπροσδοκίτους⁴ προσπεσεῖν, μηδὲ ὑπὸ φόβων ἐξαπιναίων ταρασσεσθαι καὶ ἀπόλλυσθαι.
- 7 Εὐφράτας δέ, ὁ Λακῶνων ἀρμοστής ἐπὶ Θράκης, ἐπεὶ αὐτῷ πυκνὰ ἐγίννοντο ἐν τῷ στρατεύματι τὰς νύκτας φόβοι, καὶ οὐκ ἠδύναντο ἄλλω τρόπῳ 8 παῦσαι, τοιόνδε παρήγγειλεν εἰς νύκτα. ὅταν τις θόρυβος γίνηται, ἀνακαθίζειν αὐτοὺς εὐθὺς πρὸς τὰ ὄπλα ἐν τῇ εὐνῇ, ἀνίστασθαι δὲ μηδένα ὀρθόν· ἂν δέ τις ἴδῃ τινὰ ὀρθόν, παρήγγειλεν ἐν πᾶσιν, ὥσπερ πολεμίῳ τῷ ἐπαναστάντι⁵ χρῆσθαι.
- 9 διὰ γὰρ τὸν φόβον τοῦ παραγγελθέντος οὐδένα ὦετο⁶ ἀμνημονήσειν. πρὸς δὲ τούτοις, ὅπως ἀληθῶς⁷ τὸ παράγγελμα μετὰ φόβου ἦ, γενομένου⁸ τινὸς θορύβου ἐπλήγη τις τῶν σπουδαιοτέρων ἀνδρῶν οὐχὶ θανατηφόρον, τῶν δὲ φαύλων τινὰ 10 ὥστε καὶ ἀποθανεῖν. συμβάντος δὲ τούτου ὑπήκουσάν τε οἱ ἄνθρωποι καὶ εὐλαβοῦμενοι⁹

¹ Hertlein: ὥστε M.

² C: ησσαντισ M (with some unknown mark over σσ).

³ ἐστι M.

⁴ Herm. Schöne: ἀπροσδοκίτους M.

⁵ ἐξαναστάντι Meier (cf. § 10). ⁶ Hertlein: ὦετο ἂν M.

⁷ Hercher: ἀληθὲς M. ⁸ Köchly and Rüstow: ἡγεμόνος M.

⁹ Casaubon: εὐλαβουμένου M (εὐλαβοῦμενοι B).

AENEAS THE TACTICIAN, xxvii. 4 - 10

vails. But if the commander sees any reason for fear, he must give warning by the trumpet, and this is to be understood as a call to arms. It is after a defeat in battle that such fears are most likely to arise, sometimes by day but especially by night. But that this may be less likely to happen, orders for the night should be given to all the soldiers to keep under arms as much as possible, as though something might happen where they are. Thus, if they are forewarned, it is not likely that, in case anything happens, they will be taken by surprise on colliding with the enemy, or that they will be disturbed because of sudden terror and perish.

Euphratas,¹ the Laconian governor in Thrace, since panics occurred in his army frequently at night and could not be quieted in any other way, used to give orders of this sort for the night: that if any confusion should arise, his men should immediately sit up in their beds with their arms at hand, but that no one should stand upright, and if anyone saw a man standing up, Euphratas gave orders in the hearing of all to treat him as an enemy. For he thought that through the fear which this command would inspire none would forget it. Moreover, that the command should actually inspire fear, on one occasion when a panic arose, one of the more respectable soldiers was wounded, though not mortally, while one of the baser sort was fatally injured. As a result of this, the men obeyed and, paying close attention, refrained from panics and from

¹ Nothing further is known of him, and his name is not mentioned in Porolla's *Prosopographie der Lakedaimonier*, Breslau, 1913. Some have thought that Eudamidas (Porolla, No. 295), who was campaigning in Thrace in 362 B.C., may have been meant.

AENEAS TACTICUS

- ἐπαύσαντο τῶν τε θορύβων καὶ τοῦ περιδεῶς
 11 ἐξανίστασθαι ἐκ τῶν κοιτῶν. ἐπαύθη δὲ καὶ
 τοιῶδε τρόπῳ. στρατοπέδῳ θορυβουμένῳ νυκτὸς
 κηρύξας σιγῆν¹ ὁ κήρυξ ἀνήγγειλεν τὸν μηνύσαντα
 τὸν ἀφέντα τὸν ἵππον² δι' ὃν ἦν τὸ θορυβηθῆναι δῶρον
 12 ἀργυρίου λήψεσθαι.³ χρή δ', ἂν τι τοιοῦτον ἐν
 ταῖς νυξὶ πάσῃ στρατεύμα, καθ' ἐκάστην φυλακὴν
 καθεστάναι ἐκάστου λόχου ἢ τάξεως ἐπὶ τοῖς κέρασι
 καὶ τοῖς μέσοις ἄνδρας οἱ προσέξουσιν⁴ ὅπως ἐάν τινα
 αἰσθάνωνται ἐκ τοῦ ὕπνου ἢ ἄλλως⁵ ἐρχόμενον
 θόρυβον, εὐθὺ δ'⁶ παρὼν καθέξει καὶ κωλύσει
 13 αὐτίκα. τοῦ δὲ ἄλλου πλήθους ἀπὸ συσσιτίου
 ἐκάστου ἄνδρα παραφυλάσσειν, ὅπως, ἐάν τις
 φόβος γένηται, οὗτοι δὴ⁷ εἰδότες τοὺς ματαίους
 φόβους καταπαύσωσι τοὺς παρ' αὐτῶ⁸ ἕκαστος.
 14 Αὐτὸν δὲ θορυβεῖν νυκτὸς⁹ τὸ τῶν ἐναντίων
 στρατεύμα δαμάλει τὰς ἀγελαίας μετὰ κωδῶνων
 ἀφιέντα¹⁰ εἰς τὸ στρατόπεδον καὶ ἄλλα ὑποζύγια,
 οἶνον ποτίσαντα.¹¹

[*Ἐγερσις]

- 15 Γενομένης δὲ ἡμέρας χρή τοὺς φύλακας μὴ¹²
 εὐθὺ ἀφιέναι ἐκ τῶν φυλακείων πρὶν ἢ τὰ ἕξω

¹ Casaubon: σιγῆ M.

² Casaubon: ἀφεθέντα ἵππον M.

³ Capps (taking the supplement δῶρον ἀργυρίου λήψεσθαι from Eberhard): ἵππον διώκειν θορυβηθῆναι M.

⁴ Haase: ἂν ἄρα σοι προσέξουσιν M.

⁵ Köchly and Rüstow: ἄλλω M.

⁶ Added by Herm. Schöne.

⁷ R. Schöne: δὲ M.

⁸ Köchly and Rüstow: αὐτῶ M.

⁹ Kirchhoff: νοστος M (with a mark of corruption over τ and a short space after the word). ¹⁰ Sauppe: ἀφιέντες M.

AENEAS THE TACTICIAN, xxvii. 10 - 15

rising from their beds in terror. And panics have been stopped in this way also: when confusion arose in camp at night, the herald commanded silence and announced that the man who reported the one who had turned loose the horse which had caused the commotion would receive a present of silver.¹ It is necessary, too, if an army has this sort of experience by night, to station men in each watch of the night over every company or band, both on the flanks and in the centre, to take special care that, if they should perceive any disturbance coming on because of sleep or anything else, whoever of them is at hand may check it immediately. And of the rest of the troops, there should stand on guard one man from each mess, so that if any fear should arise, they, knowing what fears are groundless, may each calm the men at his own post.

But the commander should himself throw the army of the enemy into confusion at night by driving into their camp a herd of cows wearing bells, or other animals, having first made them drunk with wine.²

[Reveille]

At daybreak one must not permit the guards to leave their posts at once until the neighbourhood

¹ Much the same story is told by Xenophon of Clearchus on the retreat after the battle of Cunaxa (*Anab.* ii. 2. 20), and by Polyænus iii. 9. 4, of Iphicrates. The idea was a good one and was probably employed more than once.

² The use of a similar device, *i.e.*, oxen with lighted faggots tied to their horns, enabled Hannibal to escape with his booty through the mountain passes of Campania (Polybius iii. 93. 10 ff.; Livy ii. 16. 5 ff.).

¹¹ Köchly and Rustow: *πορισσα* M.

¹² Added by R. Schöne (after *χρη* Meier).

AENEAS TACTICUS

προερευνηθέντα ἐμφανισθῆ καὶ καθαρὰ εἶναι πο-
 λεμίων· καὶ οὕτω ἀπιέναι τοὺς ἀπὸ τῶν φυλακῶν
 μὴ ἅμα πάντας¹ ἀλλὰ κατὰ μέρη, ὅπως αἰεὶ τινες
 ἐπὶ τοῖς φυλακείοις διατελῶσιν.

XXVIII. [Πυλωρικά]

Προνοεῖσθαι δὲ καὶ τάδε ἐν φόβῳ οὔσης πόλεως.
 πύλας τὰς μὲν ἄλλας κεκλείσθαι, μίαν δὲ ἀνεῶ-
 χθαι ἢ ἂν δυσπροσοδώτατον ἢ τῆς πόλεως καὶ
 ἐπὶ πλείστον ἀπ' αὐτῆς² μέλλωσιν ὀραῖσθαι οἱ
 2 προσιόντες, καὶ ἐν ταύτῃ ἔκτομάδα, ἵνα σώματα
 μὲν ἀνθρώπων κατὰ τὴν ἔκτομάδα πυλῖδα ἐξίη
 καὶ εἰσὶη καθ' ἓνα.³ οὕτω γὰρ ἂν ἤκιστα τις
 λανθάνοι⁴ αὐτομολῶν ἢ κατάσκοπος εἰσιῶν,
 3 ἕανπερ γε ἢ ὁ πυλωρὸς νοηρός.⁵ πᾶσαν⁶ δὲ
 ἀνοίγεσθαι ὑποζυγίων ἕνεκεν καὶ ἀμαξίων καὶ
 ἀγωγίμων ἐπισφαλές.⁷ καὶ⁸ ἕάν τι δέη εἰσενέγ-
 κασθαι σίτου ἢ ἐλαίου ἢ οἴνου ἐν τάχει ἢ τῶν
 ὁμοτρόπων τούτοις, ἀμάξαις ἢ σωμαίων πλήθει,⁹
 ταῦτα δὲ χρὴ κατὰ τὰς ἐγγύτατα¹⁰ πύλας κομίζειν,¹¹
 . . .¹² καὶ οὕτως ἂν¹³ τάχιστα καὶ ῥᾶστα εἰσκομισθείη.
 4 τὸ δ' ὅλον¹⁴ μὴ ἀνοίγεσθαι πρῶτὴ πύλας ἀπροσκέ-
 πτως ἀλλ' ὀψιαιτέρον, ἕξω τε μηδένα¹⁵ ἀφίεσθαι
 πρὶν ἢ¹⁶ ἐξερευνηῆσαι¹⁷ τὰ περὶ τὴν πόλιν· ἔτι τε
 μηδέ¹⁸ πλοῖα κατὰ ταύτας¹⁹ ὀρμίζεσθαι ἀλλ'

¹ Meineke: ἅπαντας M. ² Boivin: αὐτῶν M, J. Afr.

³ ἐν καθ' ἓν J. Afr. ⁴ Meier: λανθάνη M.

⁵ M, J. Afr.: defended by Mahlstedt.

⁶ Added by Hercher: πᾶν J. Afr.

⁷ Casaubon: ἐπισφασ (?) M: ἐπίσφας AB.

⁸ εἰ δέ τι τοῦτων ἀναγκαίως δεῖσθαι J. Afr.

⁹ J. Afr.: πάθη M. ¹⁰ Cf. note on iii. 5.

AENEAS THE TACTICIAN, xxvii. 15 – xxviii. 4

has been carefully reconnoitred and shown to be clear of the enemy. Even then they must not all leave their posts at once, but in detachments, so that some shall always continue on guard.

XXVIII. [*On Gates*]

When a city is in fear precautions must also be taken as follows. Close the other gates but leave one open where access to the city is most difficult, and where those who approach are going to be in plain sight for the longest distance. In this there should be a wicket gate so that through it men may go and come singly, for in this way a deserter or spy would be least able to escape notice if he should enter, that is, if the gate-keeper is discreet. But it is unsafe to open the entire gate for beasts of burden, wagons, and loads. And if there be any need of importing quickly food or oil or wine or similar supplies, either by wagons or by a squad of men, these should be brought in by the nearest gates, . . . as that would be quickest and easiest. In general, the gates must not be opened incautiously early in the day, but later, and no one should be let out until the region around the city has been reconnoitred. Again, boats are not to be moored

¹¹ C: κοιμίξεν M.

¹² Hercher placed a lacuna here, comparing J. Afr. προεξιόντος στρατεύματος.

¹³ Hercher: και εάν M.

¹⁴ δλον πράγμα J. Afr.

¹⁵ B (second hand) C: μηθέντα M: όψίτερόν τι μηθένα ξξω J. Afr.

¹⁶ αν J. Afr.

¹⁷ έξερευνήση J. Afr.

¹⁸ Hercher: μήτε M, J. Afr.

¹⁹ κατ' αυτάς J. Afr.

AENEAS TACTICUS

ἀπωτέρω, ὡς ἤδη γε καὶ ἡμέρας¹ πολλαὶ πράξεις ἀνοιχθειῶν ἀμφοτέρων πυλῶν γεγόνασιν ἐπὶ τεχνασμάτων καὶ προφάσεων τοιῶνδε· γνωσθήσεται δὲ² ἐφ' ἐνὸς ἔργου πολλὰ παραπλησίως
 5 τούτῳ πραχθέντα. Πύθων μὲν ὁ Κλαζομένιος, καὶ τῶν ἐν τῇ πόλει τινῶν συνεθειόντων, τηρήσας τελέως τὸ ἡσυχαιάτατον³ τῆς ἡμέρας, ἀμάξαις ἐκ παρασκευῆς πίθους εἰσαγούσαις κατέλαβε Κλαζομένιας· μενουσῶν⁴ ἐν ταῖς πύλαις τῶν ἀμαξῶν, καθ' ἅς, ξένων προὔπαρχόντων κρυφαίως οὐ πόρρω τῆς πόλεως, τοὺς μὲν τῶν πολιτῶν λαθόντες, τοὺς δὲ φθάσαντες, τινὰς δὲ τῶν ἔσω συνεργοὺς
 6 ἔχοντες κατέσχον τὴν πόλιν. Ἰφιάδης τε Ἀβυδηνὸς κατὰ Ἑλλησποντον καταλαμβάνων Πάριον ἄλλα τε περὶ τὴν ἀνάβασιν νυκτὸς ἐπὶ τοῦ τείχους λάθρα παρεσκευάσατο⁵ καὶ ἀμάξας πληρώσας φρυγάνων καὶ βάτων παρέπεμψεν πρὸς τὸ τεῖχος, ἤδη τῶν πυλῶν κεκλεισμένων, ὡς τῶν Παριανῶν οὔσας τὰς ἀμάξας, αἵτινες⁶ ἐλθοῦσαι πρὸς τὰς
 7 πύλας ἠυλίζοντο, ὡς φοβούμεναι πολεμίους. ἅς ἔδει ἐν καιρῷ τινὶ ὑφαφθῆναι, ἵνα αἱ πύλαι ἐμπρησθῶσι καὶ πρὸς τὸ σβεννύειν τῶν Παριανῶν ὀρμησάντων αὐτὸς κατὰ ἄλλον τρόπον εἰσέλθῃ.

Δοκεῖ δέ μοι συναγαγόντι⁷ δηλωτέον τίνα δεῖ φυλάσσεσθαι⁸ καὶ ἐν οἷς καιροῖς ἕκαστα, ἵνα τις μηδὲν εὐήθως ἀποδέχηται.

¹ Gronov: ἡμέραι M.

² Suggested by Herm. Schöne: τοιῶνδε ἐφ' M.

³ Hercher: ἡσυχότατον M.

⁴ Added by Casaubon: R. Schöne suggests plausibly κατάξας τινὰ ἢ μίαν (sc. ἀμαξαν). ⁵ παρασκευάσατο M.

⁶ Herm. Schöne: ἐτι ἐγγύς M. ⁷ Casaubon: συναγαγόντα M.

⁸ Haase, Kirchoff: ἵνα δὴ φυλάσσηθε M.

at the gates, but at a distance, since in time past, even in the daytime, when both gates have been open at once, many things have happened by tricks and pretexts such as the following—and from a single occurrence many cases similar to it will be understood. Pytho of Clazomenae,¹ having also some confederates in the city, watched carefully for the most quiet hour of the day, and captured Clazomenae by means of wagons, which, in accordance with his plan, were bringing in wine-jars. While the wagons were stopping in the gates (for there were mercenaries ready in concealment not far from the city near the gates), his men, eluding some of the citizens and outstripping the others, with the aid of some persons inside got possession of the city. And Iphiades of Abydus² on the Hellespont, in his capture of Parium, among other preparations for scaling the wall by night, secretly prepared wagons filled with brush and brambles and sent them to the wall (the gates being already closed), as though they were wagons of the Parians, which after their arrival were parked near the gates from fear of the enemy. At a suitable moment they were to set fire to the wagons, so that the gates might catch fire, and when the citizens of Parium had gone to put out the flames he himself might enter at another point.

It seems to me that I must show, by a collection of instances, against what things one must guard and on what occasions, so that one may not be so simple as to take anything for granted.

¹ Otherwise entirely unknown.

² He is known merely as a tyrant of Abydus at the time of Aeneas (Aristotle, *Politics*, 1306 a 30; Demosthenes xxiii. 176 f.).

AENEAS TACTICUS

XXIX. [Ὅπλων λάθρα εισκομιδῆ]

Περὶ δὲ τῶν εισκομιζομένων εἰς τὴν πόλιν ἀγγείων τε καὶ φορημάτων, ἐν οἷς ἂν τι κρυφαῖον ἐνεῖη, οἷς¹ ἤδη πόλις καὶ ἡ ἀκρόπολις κατελήφθη, 2 νῦν δηλωθήσεται. ἅπερ εὐλαβεῖσθαι δεῖ καὶ μὴ ἀφροντίστως αὐτῶν ἔχειν, καὶ μάλιστα τὸν πυλωρὸν ἐν τισι καιροῖς, ὅταν ἔξωθέν τι ἢ ἔσωθεν φοβερὸν ᾖ. ἔστιν δὲ οἱ προσεκτέον εισκομιζο- 3 μένοις. ἐξοίσω δὲ καὶ παραδείγματος ἕνεκεν ἐπὶ πράξει γεγενημένα. κατελήφθη γὰρ πόλις,² ἔσωθέν τινων συνθελόντων, ἐν ἑορτῇ πανδήμῳ 4 τρόπῳ τοιῶδε. πρῶτον μὲν τοῖς προενδημήσασι ξένοις ἐπὶ τὸ μέλλον³ καὶ πολιτῶν τοῖς ἀνόπλοις τε καὶ συνεργοῖς ἔσομένοις εισεκομίσθησαν θύρακες λίνεοι⁴ καὶ στολίδια⁵ καὶ περικεφαλαῖα⁶ ὅπλα κνημίδες μάχαιραι τόξα τοξεύματα ἐν κιβωτοῖς⁷ ὡς φορταγωγοῖς κατεσκευασμένα,⁸ ὡς ἱματίων ἐνό- 5 των καὶ ἄλλων ἀγωγίμων· ἅπερ οἱ ἐλλιμενισταὶ ἀνοίξαντες καὶ ἰδόντες ὡς ἱμάτια μόνον κατεσημῆναντο, μέχρι τιμήσονται οἱ εἰσαγαγόντες. 6 καὶ ταῦτα μὲν ἐτέθη ἐγγὺς τῆς ἀγορᾶς, ὅπου ἔδει· ἐν δὲ ταρσοῖς καὶ ῥίποις καὶ ἰστοῖς⁹ ἡμι-

¹ Casaubon: ἀντικρυφαιον ἐνίοις M.

² Meineke conjectured here Ἄμφίπολις and for ἐπὶ πράξει either ἐπὶ Θραξί or ἐν τοῖς ἐπὶ Θράκης (see explanatory note).

³ Hunter places these words after συνεργοῖς.

⁴ Behrendt (λινέους J. Afr.): λιναῖοι M.

⁵ στολίδια J. Afr.

⁶ Defended by Mahlstedt: περικεφαλαίας J. Afr.

⁷ κιβωτοῖς J. Afr.

⁸ This reading of M and J. Afr. is retained by Casaubon and Behrendt; it is generally changed to κατασκευασμένοις (or -αις).

⁹ Köchly and Rüstow: ἰστοῖς M.

XXIX. [*Importation of Arms by Stealth*]

I shall now discuss the smuggling into the city of jars and packages, in which there may be something hidden by means of which a city with its acropolis has in past instances been seized. These matters must be attended to and not disregarded, particularly by the gate-keeper, at certain times, when there is reason to fear any disturbance from without or within; and he should look to it when things are being brought in. I shall relate likewise, as illustration, some things that have actually happened. A city was captured, with the complicity of some within it, upon a public holiday, in some such manner as this.¹ First of all, to the aliens who had established themselves there in anticipation of what was to take place, and to the unarmed citizens who were to be accomplices there were brought in linen corslets, cloaks, helmets, shields, greaves, short swords, bows, arrows, stowed away in chests like those of merchants, with the statement that clothing and other merchandise were in them. The revenue officers, opening these, and seeing what they thought was only clothing, affixed their seals until the importers should put a value upon them. These cases were then stored in a convenient spot near the market-place. In crates also and wicker frames and wrapped up in half-woven

¹ Meineke, by clever emendations, made it out that the city was Amphipolis, and the occasion the capture by Brasidas in 424-3 B.C., which caused Thucydides to be exiled. But a careful comparison with the conditions described by Thucydides iv. 103 ff. makes it clear that that occurrence is not the one referred to here.

AENEAS TAÏTICUS

υφάντοις¹ δοράτια καὶ ἀκόντια ἐνειλημένα εἰσ-
 ηνέχθη, καὶ ἐτέθη ὅπου ἕκαστα συνέφερον ἀν-
 υπόπτως· ἐν δ' ἄγγελισιν ἀχύρων καὶ ἐρίων πέλται
 καὶ μικρὰ ἀσπίδια² ἐν τοῖς ἐρίοις καὶ ἀχύροις³
 κεκρυμμένα, καὶ ἄλλα εὐογκότερα ἐν σαργάναις
 ἀσταφίδος καὶ σύκων πλήρεις, ἐγχειρίδια δὲ ἐν
 7 ἀμφορεῦσι πυρῶν καὶ ἰσχάδων καὶ ἐλαιῶν. εἰσ-
 ηνέχθη δὲ ἐγχειρίδια καὶ ἐν σικυοῖς πέποσι γυμνά,
 ἀπεωσμένα⁴ κατὰ τοὺς πυθμένας εἰς τὸ σπέρμα
 τῶν σικυῶν. ὁ δ' ἐπιβουλεύων τε καὶ ἡγεμῶν
 8 ἔξωθεν εἰσηνέχθη ἐν φρυγάνων φορήματι. νυκτὸς
 δὲ γενομένης καὶ ἀθροισθέντων τῶν ἐπιθησομένων,
 ἕκαστος ὃν ἔδει τηρήσαντες καιρὸν, ἐν ᾧ μάλιστα
 οἰνωμένοι ἦσαν οἱ ἄλλοι κατὰ τὴν πόλιν οἶα δὴ⁵
 ἐν ἑορτῇ, πρῶτον μὲν τὸ φόρημα ἐλύθη, καὶ ἐξ
 αὐτοῦ⁶ ὁ ἡγεμῶν ἔτοιμος ἦν· ἔπειτα ἄλλοι μὲν
 αὐτῶν τοὺς ταρσοὺς ἐξείλισσον⁷ πρὸς τὰς λήψεις
 τῶν δοράτων καὶ ἀκοντίων, ἕτεροι⁸ δὲ τὰ ἄγγη
 τῶν ἀχύρων καὶ ἐρίων ἐξεκένουν,⁹ οἱ δὲ τὰς
 σαργάνας ἀνέτεμνον,¹⁰ ἄλλοι δὲ τὰς κιβωτοὺς
 ἀνοίγοντες τὰ ὄπλα ἐξήρουν, οἱ δὲ τοὺς ἀμφορέας
 συνέτριβον, ἵνα ταχεῖα ἢ λήψις τῶν ἐγχειριδίων
 9 γένοιτο. ἅμα δὲ ταῦτα καὶ οὐ πόρρω ὄντα
 ἀλλήλων ἐπορσύνετο ἀπὸ σημείου τοῦ ἐν τῇ πόλει
 10 καὶ ὡς φάλαγξι γενομένου.¹¹ ὄπλισθέντες¹² δ'
 ἕκαστοι τοῖς προσήκουσιν ὄπλοις οἱ μὲν τινας
 αὐτῶν ἐπὶ πύργους ὤρμησαν καταλαβεῖν καὶ

¹ ἡμιφαντιαλοῖς J. Afr.

² ἀσπιδίσκια J. Afr.

³ Casaubon: ἀχύρεσ M.

⁴ Casaubon: ἀπεω ω ενα M (with mark of corruption over second ω).

⁵ Schenkl: οἱ δὲ M.

⁶ ἐξ αὐτῆς ('forthwith') Eberhard, Mor. Schmidt.

⁷ Meineke: ἐξέλισσον M.

⁸ Meineke: ἕτερος M.

sail-cloth, spears and javelins were brought in, and, without arousing suspicion, placed where each would be serviceable. And in baskets of chaff and of wool, bucklers and small shields were concealed in the wool and chaff; and others still smaller in baskets full of raisins and figs, as well as daggers concealed in jars of wheat and dried figs and olives. And daggers were likewise carried in unsheathed in ripe gourds, pushed down along the stems among the seeds of the gourd. Likewise the deviser and leader of the plot was carried in from without hidden in a load of faggots. And when night was come, and those who were to make the attack were assembled, and each one was looking out for the opportune time, at which all the rest of the citizens were completely intoxicated (as would be likely on a festival day), first of all the load was loosened and out of it came the leader ready prepared. Then some of them unrolled the crates to seize the spears and javelins, others emptied the baskets of chaff and wool, others cut open the hampers, others, opening the chests, took out the arms, and still others smashed the jars so as to lay hands upon the daggers as quickly as possible. All these things took place at the same time and not far away from each other, at a signal given in the city as if for battle array. And when each one had equipped himself with arms suited to him, some of them rushed to seize the towers and the gates, through which they

⁹ Added by Hercher (very uncertain).

¹⁰ Hercher: *ἀνέτεμον* M.

¹¹ R. Schöne: *γινόμενον* M: *καὶ ὡς φάλαγξ ἦν τὸ γινόμενον* Meineke: *ταῖς ἐξω φάλαγξι γενομένου* Hug.

¹² B (second hand) C: *ὀπλισθέντας* M.

AENEAS TACTICUS

πύλας, καθ' ἃς καὶ τοὺς¹ ἄλλους προσεδέχοντο, οἱ δὲ ἐπὶ τὰ ἀρχεῖα καὶ τὰς ἐναντίας² οἰκίας, οἱ δέ, ἄλλοι³ ἄλλων τόπων εἶχοντο.

- 11 Εἰς δὲ ὁμοίας πράξεις τῶν εἰρημένων δεόμενοι τινας ἀσπίδων ἐπεὶ οὐδενὶ ἄλλῳ τρόπῳ ἐδύναντο ἐτοιμάσασθαι οὐδὲ εἰσαγαγέσθαι, πλῆθος οἰσῶν⁴
- 12 καὶ ἐργάτας ἅμα τούτων⁵ εἰσηγάγοντο. καὶ ἐν μὲν τῷ φανερωῷ ἄλλα ἀγγεῖα ἐπλεκον, ἐν δὲ ταῖς νυξίν ὄπλα, περικεφαλαίας καὶ ἀσπίδας, ἐπλεκον, αἷς ὄχανα περιετίθεισαν⁶ σκύτινα⁷ καὶ ξύλινα. ἀλλὰ μὴν οὐδὲ τῶν κατὰ θάλατταν προσορμιζομένων πλοίων νυκτὸς καὶ ἡμέρας οὔτε μεγάλων οὔτε μικρῶν ἀδιασκέπτως⁸ ἔχειν, ἀλλὰ ἐμβαίνοντας τοὺς λιμενοφύλακας τε καὶ ἀποστολέας ἰδεῖν αὐτοῦ,⁹ τὰ ἀγώγιμα, ἐνθυμουμένους¹⁰ ὅτι καὶ Σικυώνιοι ἀμελήσαντες τῶν τοιούτων μεγάλα ἐσφάλησαν.

XXX. [Περὶ ὄπλων εἰσαγωγῆς]

Προνοεῖν δὲ καὶ τὰ ἐπὶ πράσει εἰσαγόμενα καὶ εἰς τὴν ἀγορὰν ἐκτιθέμενα ὄπλα τὰ τε ἐπὶ τῶν καπηλείων καὶ παντοπωλείων, ὧν¹¹ ἀθροισθέντων πλῆθος τι γένοιτ' ἂν,¹² ὅπως μηδενὶ ἔτοιμα ἢ 2 τῶν βουλομένων νεωτερίζειν· εὖηθες γὰρ τῶν μὲν

¹ Köchly and Rüstow, and Hercher from J. Afr.

² ἐναντίων Casaubon: τῶν ἐ. Köchly and Rüstow (cf. J. Afr. τὰς πολέμου [for πολεμίων] οἰκίας).

³ Herm. Schöne: οἱ δὲ ἄλλοι M.

⁴ Oldfather: ὄπλα οἰσῶν M (with mark of corruption over ω): ὄπλα suspected by Hercher: οἰσῶς Casaubon: οἰσῶν R. Schöne: ὄπλα, πλῆθος οἰσῶν Hunter.

⁵ Hertlein: ὁύτως M.

⁶ προσετίθεισαν Meineke.

admitted the rest also ; others fell upon the city. hall and the houses opposite ; some took one place and some another.

In an enterprise similar to the kind already described, certain persons were without shields, and when in no other manner were they able to provide or import them, they brought in quantities of osiers and also workmen to handle them. And by day they wove other kinds of basketry, but by night they wove armour, such as helmets and shields, to which they attached leathern and wooden handles. Furthermore, it is necessary to be watchful not only of vessels which come in by sea to anchor near by, night or day, whether great or small, but also it is necessary for the inspectors of the port and the supervisors to go on board and personally to see the wares, having in mind that the Sicyonians also, forgetting such precautions, suffered a serious disaster.

XXX. [*On the Introduction of Arms*]

One ought also to take precautions in regard to the arms imported for sale and displayed in the market-place, likewise those in the small shops and the bazaars (since these, if gathered together, would make a considerable number), to prevent them from being ready at hand for anyone of those who desire to start a revolution. For it is silly to take

⁷ Casaubon: *συκινα* M.

⁸ J. Afr. *διασκέπτως* M: *δεῖ ἀσκέπτως* Köchly and Rustow.

⁹ J. Afr.: *εἰδέναι αὐτοῖσ* M.

¹⁰ J. Afr.: *εὐθυμουμένονσ* M.

¹¹ Added by Casaubon.

¹² Schenkl: *γένουτο* M.

AENEAS TACTICUS

ἀφικνουμένων ἀνδρῶν παραιεῖσθαι τὰ ὄπλα, ἐν δὲ τῇ ἀγορᾷ καὶ ταῖς συνοικίαις ἀθρόα ὑπάρχειν σωράκου¹ τε ἀσπιδίων καὶ ἐγχειριδίων κιβώτια. διὸ δεῖ τὰ εἰσαφικνούμενά τε καὶ ἡθροισμένα ὄπλα μὴ ἐκφέρεσθαι τε εἰς τὴν ἀγορὰν καὶ νυκτερεύειν ὅπου ἂν τύχη, ἀλλὰ πλὴν δείγματος τὸ ἄλλο πλῆθος πρὶν² ἐκτίθειτό τις, εἶναι δημοσία³ κρίνειν.

XXXI. [Περὶ ἐπιστολῶν κρυφαίων]

Περὶ δὲ ἐπιστολῶν κρυφαίων παντοῖαι μὲν εἰσὶν αἱ πέμψεις, προσυγκείσθαι δὲ δεῖ⁴ τῷ πέμψαντι καὶ δεχομένῳ ἰδίᾳ· αἱ δὲ λανθάνουσαι μάλιστα τοιαῖδε ἂν εἶεν. ἐπέμφθη ἐπιστολή² ὧδε. εἰς φορτία ἢ ἄλλα σκευὴ ἐνεβλήθη βυβλίον ἢ ἄλλο τι γράμμα⁵ τὸ τυχὸν καὶ μεγέθει καὶ παλαιότητι. ἐν τούτῳ δὲ γέγραπται⁶ ἢ ἐπιστολή ἐπιστιζομένων γραμμάτων τοῦ πρώτου στίχου⁷ ἢ δευτέρου ἢ τρίτου, ἐπιστιγμαῖς δὲ ἐλαχίσταις καὶ ἀδηλοτάταις πλὴν τῷ πεμπομένῳ. εἶτα ἀφικομένου τοῦ βυβλίου παρ' ὃν δεῖ,⁸ ἐξεγράφετο καὶ τὰ ἐπισημασμένα γράμματα τιθεὶς ἐφέξῃς τὰ ἐκ τοῦ πρώτου στίχου καὶ δευτέρου καὶ τὰ³ ἄλλα ὡσαύτως, ἐγνώριζε τὰ ἐπισταλέντα. ὀλίγα δ' ἂν τις θέλων ἐπιστεῖλαι καὶ ὧδε ποιῆσαι,

¹ Casaubon: *συρακου* M.

² Added by Herm. Schöne.

³ Schenkl: *δημοσία* M (*δημόσια* generally).

⁴ Added by Casaubon.

⁵ Meineke: *δράμα* M.

⁶ δ' ἐγέγραπτο Hertlein.

⁷ Added by Hug: *γραμμάτων ἢ* M. It would seem, however, that something more has fallen out.

⁸ ἔδει Hertlein.

away the weapons from men who are entering the town¹ while there are assembled in the market-place and the lodging-houses boxes of small shields and chests of daggers. Accordingly the imported and collected arms ought not to be exposed in the market-place and be left overnight in any chance spot, but, with the exception of a sample, official permission may be required before anyone exhibits them in bulk.

XXXI. [*On secret Messages*]

In regard to secret messages, there are all sorts of ways of sending them, but a private arrangement must be previously made between the sender and the receiver. Especially secret messages might take the following forms. In one case a message was sent in this way: in with merchandise or other baggage there was inserted a book, or some other chance document, of any size or age, and in this the message had been written by marking the letters of the first, second, or third line with dots, very small and discernible only to the recipient. Then, when the person intended received the book, he made a transcript, and by setting down in order the marked letters from the first line and the second and the others in the same way he discovered the message.² But should anyone wish to send a brief

¹ See Chap. x. 9.

² The following instance from recent events may be of interest in this connexion: "Chandra (that is, Ram Chandra, the editor of a Hindoo revolutionary paper in San Francisco) got all the news he wanted for his paper from India, and said he did it through copies of the Koran, marked peculiarly" (*The Washington Post*, April 24, 1918, p. 1, col. 6).

AENEAS TACTICUS

παρόμοιον τούτῳ. ἐπιστολὴν γράψαντα¹ περὶ
 τωνων φανερώς ἐν πλείοσιν, ἐν ταύτῃ τῇ ἐπιστολῇ
 τὸ αὐτὸ ποιεῖν ἐπισημαινόμενον γράμματα, δι-
 ὄτων² ἐμφανίεις ἄπερ ἂν βούλη.³ τὴν δὲ ἐπι-
 σημασίαν εἶναι ὡς ἀδηλοτάτην ἐπιστιγμαῖς διὰ
 πολλοῦ ἢ γραμμαῖς παραμήκεσιν. ἂ τοῖς μὲν
 ἄλλοις μηδεμίαν ὑπόνοιαν ἔξει, τῷ δὲ πεμπομένῳ
 4 γνωστὴ ἔσται ἡ ἐπιστολή. . . .⁴ πεμπέσθω ἀνὴρ
 ἀγγελίαν φέρων τινὰ ἢ καὶ ἐπιστολὴν περὶ ἄλλων
 φανερῶν· τοῦ δὲ μέλλοντος πορεύεσθαι κρυφαίως
 αὐτοῦ εἰς τὸ τῶν ὑποδημάτων πέλμα ἐντεθήτω
 εἰς τὸ μεταξὺ βυβλίον καὶ καταραπτέσθω, πρὸς
 δὲ τοὺς πηλοὺς καὶ τὰ ὕδατα εἰς κασσίτερον
 ἐλληλασμένον⁵ λεπτόν γραφέσθω πρὸς τὸ μὴ
 ἀφανίζεσθαι ὑπὸ τῶν ὑδάτων τὰ γράμματα.
 4^a ἀφικομένου δὲ παρ' ὃν δεῖ, καὶ ἀναπαυομένου ἐν
 τῇ νυκτί, ἀναλύετω τὰς ῥαφὰς τῶν ὑποδημάτων,
 καὶ ἐξελὼν καὶ ἀναγνούς, ἄλλα γράψας λάθρα ἔτι
 καθεύδοντας καὶ ἐγκαταρράψας ἀποστελλέτω τὸν
 ἄνδρα, ἀνταγγείλας ἢ⁶ καὶ δούς τι⁷ φέρειν φανερώς.
 5 οὕτως οὖν οὔτε ἄλλος οὔτε ὁ φέρων εἰδήσει· χρὴ δὲ
 τὰς ῥαφὰς τῶν ὑποδημάτων ὡς ἀδηλοτάτας ποιεῖν.
 6 Εἰς Ἔφεσον δ' εἰσεκομίσθη γράμματα τρώπῳ
 τοιῷδε. ἄνθρωπος ἐπέμφθη ἐπιστολὴν ἔχων
 φύλλοις ἐγγεγραμμένην,⁸ τὰ δὲ φύλλα ἐφ' ἔλκει

¹ Köchly and Rüstow: γράψας M.

² Herm. Schöne: δὲ ὅτε M.

³ Kirchhoff: ἐμφανὴ ὡσπερ ἐν βούλλῃ M.

⁴ Hercher placed a lacuna here.

⁵ Meineke: ἠλασμένον M.

⁶ Herm. Schöne (partly after Hercher): ἀποστείλας καὶ M
 (defended by Behrendt and Mahlstedt): ἀνταποστείλας J.
 Afr.: ἀντεπιστείλας Köchly and Rüstow.

message, he might use also the following method, which is similar to the preceding. Writing in detail and undisguisedly on some subject, in this message you may reach the same result by marking letters by which you will indicate whatever you may wish. And the marking must be made as inconspicuous as possible, by dots placed far apart or by rather long dashes. These will arouse no suspicion whatsoever in others, but the letter will be clear to the recipient. . . . Let a man be sent bearing some message or even a letter ostensibly about general matters, not secret, and, just before he starts, without his knowledge let a letter be inserted in the sole of his sandals and be sewed in,¹ and, to guard against mud and water, have it written on a piece of thin-beaten tin, so that the writing will not be effaced by the water. And when he reaches the one intended and goes to rest for the night, this person should pull out the stitchings of the sandals, take out and read the letter, and, writing another secretly while the man is still asleep, sew it in and send him back, having given him some message in reply or even something to carry openly. In this way, then, neither the messenger nor anyone else will know the message. It is necessary, however, to make the scwings of the sandals as inconspicuous as possible.

Again, a letter was brought to Ephesus in some such manner as this. A man was sent with a message written on leaves which were bound to a

¹ This particular device is mentioned by Ovid in the *Art of Love*, iii. 621 ff.

² Köchly and Rüstow: τε M, J. Afr.

³ Meineke: γεγραμμένην M.

AENEAS TACTICUS

7 καταδεδεμένα ἦν ἐπὶ κνήμην. εἰσενεχθείη δ' ἂν γραφή καὶ ἐν τοῖς τῶν γυναικῶν ὡσὶν ἔχουσιν¹ ἄντ' ἐνωτίων ἐλασμοὺς ἐνειλημένους λεπτοὺς μολι-
 8 βδίνους.² ἐκομίσθη δὲ ἐπιστολὴ περὶ προδοσίας³ εἰς στρατόπεδον ἀντικαθημένων πολεμίων⁴ ὑπὸ τοῦ προδιδόντος ὧδε. τῶν ἐξιόντων ἱππέων ἐκ τῆς πόλεως εἰς προνομὴν τῶν πολεμίων ἐνὶ ἐγκατερράφῃ ὑπὸ τὰ πτερύγια τοῦ θώρακος βιβλίον ὦ⁵ ἐντέταλτο, εἴαν τις ἐπιφάνεια τῶν πολεμίων γένηται, πεσεῖν ἀπὸ τοῦ ἵππου ὡς ἄκοντα καὶ ζωγρηθῆναι. καὶ γενομένου δ' ἐν τῷ στρατοπέδῳ ἀποδοθῆναι⁶ τὸ βιβλίον ὦ ἔδει.⁷ ὑπῆρέτησεν
 9 δ' ὁ⁸ ἱππεὺς ἀδελφὸς ἀδελφῶ.⁹ ἄλλος δὲ ἱππέα ἐκπέμπων εἰς τὴν ἡνίαν τοῦ χαλινοῦ βιβλίον ἐνέρραψεν.¹⁰ ἐγένετο δὲ περὶ ἐπιστολὴν τοιόνδε. πόλεως γὰρ πολιορκουμένης ἐπεὶ παρήλθεν ἔσω τῆς πόλεως ὁ κομίζων τὰς ἐπιστολὰς τῷ μὲν προδιδόντι καὶ τοῖς ἄλλοις οἷς ἔφερεν¹¹ οὐκ ἀποδίδωσιν, πρὸς δὲ τὸν ἄρχοντα τῆς πόλεως ἦλθεν
 9' μνηνῶν καὶ τὰς ἐπιστολὰς ἐδίδου. ὁ δ' ἀκούσας ἐκέλευεν ταύτας μὲν τὰς ἐπιστολὰς οἷς ἔφερεν¹² ἀποδοῦναι, τὰ¹³ δὲ παρ' ἐκείνων, εἰ ἀληθῆς τι μνηνύει, παρ' αὐτὸν ἐνεγκεῖν· καὶ ὁ μνηνῶν ταῦτα ἔπραξεν. ὁ δὲ ἄρχων λαβὼν τὰς ἐπιστολὰς καὶ ἀνακαλεσάμενος τοὺς ἀνθρώπους τὰ σημεῖά τε

¹ Köchly and Rüstow: ἐχούσαις M.

² Köchly and Rüstow: ἐνωτίων ἐνειλημένοις λεπτοῖς μολιβδίνουσι M.

³ Casaubon: προσοδίας M.

⁴ Casaubon: ἀντικαθημενον πολέμιον M.

⁵ Casaubon: ἐν ᾧ M.

⁶ Hercher suggested plausibly ἀπεδόθη.

⁷ Hertlein (Hercher?): ὡς δεῖ M.

⁸ Capps: δέ M.

wound on his leg. Writing could be brought in also on thin pieces of beaten lead rolled up and worn in women's ears in place of ear-rings. A letter having to do with betrayal was once conveyed by the traitor to the camp of the beleaguering enemy in this way. As the horsemen were going out of the city for a raid upon the enemy one of them had a sheet of papyrus sewn under the flaps of his breast-plate, and he was instructed, if the enemy should appear, to fall from his horse as though by accident, and to be captured alive; and when he was taken into camp he was to give the sheet of writing to the proper person. The horseman assisted as a brother would a brother.¹ Another man, when sending out a horseman, sewed a sheet of papyrus to the bridle-rein. And the following incident happened about a letter. During the siege of a city, when the man carrying the message entered the town, he did not give the letters to the traitor and to the others to whom he was bringing it, but went to the commanding officer of the city, disclosed the matter, and handed over the letters. When the officer heard it he ordered him to deliver these letters to those to whom he was bringing them, but to bring to him their answer as evidence that he was telling the truth. The informer did so, and the officer, taking the letters, called the men to him, showed them the

¹ A proverbial expression; cf. Plato, *Rep.* ii. p. 362 D ἀδελφὸς ἀνδρὶ παρῆι.

⁹ Kirchhoff: ὑπηρητησ εν . . . ἀδελφὸν M.

¹⁰ Casaubon: ἐνέγραψεν M.

¹¹ R. Schöne: καὶ προσέφερον M (with mark of corruption over ο).

¹² Casaubon: ἔφερον M.

¹³ sc. γράμματα (R. Schöne): τὰς Casaubon.

AENEAS TACTICUS

- ἔδεικνυεν τῶν δακτυλίων, ἅπερ ὠμολόγουν αὐτῶν¹ εἶναι, καὶ λύων τὰ βιβλία ἐδήλου τὸ πρᾶγμα.
- θ¹ τεχνικῶς δὲ δοκεῖ φωρᾶσαι, ὅτι τὰς πεμπομένας παρὰ τοῦ ἀνθρώπου οὐκ ἀπέλαβεν.² ἦν γὰρ αὐτοῖς ἀρνηθῆναι καὶ φάσκειν ἐπιβουλεύεσθαι ὑπό τινος. τὰς δ' ἀνταποστελλομένας λαβῶν ἀναντιλέκτως³ ἤλεγξεν.
- 10 Κομίζεται δὲ καὶ ὧδε. κύστιν ἰσομεγέθη ληκύθῳ ὀπόσῃ ἂν βούλῃ⁴ πρὸς τὸ πλήθος τῶν γραφησομένων φυσήσαντα καὶ ἀποδήσαντα⁵ σφόδρα ξηρᾶναι, ἔπειτα ἐπ' αὐτῆς γράψαι ὅ τι ἂν
- 11 βούλῃ⁶ μέλανι κατακόλλῳ. ξηρανθέντων δὲ τῶν γραμμᾶτων ἐξελεῖν⁷ τὴν πνοὴν τῆς κύστιδος καὶ συμπιέσαντα⁸ εἰς τὴν⁹ λήκυθον ἐνθεῖναι· τὸ δὲ στόμα τῆς κύστιδος ὑπερεχέτω τοῦ στόματος¹⁰
- 12 τῆς ληκύθου. ἔπειτα φυσήσαντα τὴν κύστιν ἐν τῇ ληκύθῳ ἐνούσαν, ἵνα διευρυνθῇ¹¹ ὡς μάλιστα, καὶ¹² ἐλαίου ἐμπλήσαντα περιτεμεῖν τῆς κύστιδος τὸ ὑπερέχον τῆς ληκύθου καὶ προσαρμόσαι τῷ στόματι ὡς ἀδηλότατα, καὶ βύσαντα τὴν λήκυθον κομίζειν φανερώς. διαφανές τε οὖν τὸ ἔλαιον ἔσται ἐν τῇ ληκύθῳ καὶ οὐδὲν ἄλλο φανεῖται
- 13 ἐνόν. ὅταν δὲ ἔλθῃ παρ' ὃν δεῖ, ἐξεράσας τὸ ἔλαιον ἀναγνώσεται φυσήσας τὴν κύστιν· καὶ ἐκσπογγίσας καὶ κατὰ ταῦτά εἰς τὴν αὐτὴν γράψας
- 14 ἀποστελλέτω. ἦδη δέ τις¹³ ἐν δέλτου¹⁴ ξύλῳ

¹ Köchly and Rüstow: αὐτὸν M.

² Hertlein (οὐκ ἔλαβε Casaubon): ὅτι καὶ ἔλαβεν M.

³ Casaubon: ἂν ἀντιλεπτως M.

⁴ Casaubon (βούλη Lange): ὀπόσῃ ἀντιβούλει M: ὀπόσῃ ἀντιβουλεῖ Eberhard: ὀπόσῃ ἂν βούλη Lange.

⁵ Köchly and Rüstow: φυσήσας καὶ ἀποδήσας M.

⁶ Meier: βούλει M.

marks of the seals which they admitted to be their own, and, opening the letters, exposed the matter. And he seems to have detected this skilfully in that he did not accept from the man the letters that were sent. For then it would have been possible for the men to deny it and claim that someone was plotting against them. But by taking the letters that were sent in answer he proved the case incontestably.

Messages are sent also in this way. Take a bladder in size equal to a flask large enough for your purpose ; inflate it, tie it tightly, and let it dry ; then write on it whatever you wish, in ink mixed with glue. When the writing is dry, let the air out of the bladder, and press it into the flask, letting the mouth of the bladder protrude from the mouth of the flask. Then inflate the bladder inside the flask in order to expand it as much as possible, and filling it with oil, cut off the part of the bladder that comes over the top of the flask, fitting it in the mouth as inconspicuously as you can, and, corking the bottle, carry it openly. Hence the oil will be visible in the flask, but nothing else. When it comes to the appropriate person, he will pour out the oil, inflate the bladder, and read the writing. And washing it off with a sponge, let him write on it in the same manner and send it back. It has actually happened that someone has written on the wooden part

⁷ Kochly and Rüstow : ἐξέλε M.

⁸ Köchly and Rüstow : συμπιέσαντας M.

⁹ Added by Hercher.

¹⁰ Köchly and Rüstow : τοῦ πωματος M.

¹¹ Gronov : διερβυθῆ M.

¹² Added by Köchly and Rüstow.

¹³ Casaubon : τινεσ M.

¹⁴ Hercher : δέλτω M : τῷ τῆς δέλτου ξύλω J. Afr.

AENEAS TACTICUS

γράψας κηρὸν ἐπέτηξεν¹ καὶ ἄλλα εἰς τὸν κηρὸν ἐνέγραψεν. εἶτα ὅταν ἔλθῃ παρ' ὃν ἔδει,² ἐκκνήσας³ τὸν κηρὸν καὶ ἀναγνοὺς γράψας πάλιν ὡσαύτως⁴ ἐπέστειλεν. ἐνδέχεται⁵ δὲ καὶ εἰς πυξίον γράψαντα μέλανι ὡς βελτίστῳ εἶναι ξηρανθῆναι, ἔπειτα λευκώσαντα ἀφανίζειν τὰ γράμματα. ὅταν οὖν ἀφίκηται παρὰ τὸν πεμπόμενον, λαβόντα εἰς ὕδωρ θεῖναι τὸ πυξίον· φανεῖται οὖν ἐν τῷ ὕδατι
 15 ἀκριβῶς ἅπαντα τὰ γεγραμμένα. γράφοιτο δ' ἂν καὶ εἰς πινάκιον ἡρωϊκόν⁶ ἄπερ ἂν βούλῃ.⁷ ἔπειτα καταλευκῶσαι καὶ ξηράναντα γράψαι ἰππία φωσφόρον ἢ ὃ τι ἂν βούλῃ,⁷ ἔχοντα⁸ ἱματισμὸν λευκὸν καὶ τὸν ἵππον λευκόν· εἰ δὲ μή, καὶ ἄλλῳ χρώματι, πλὴν μέλανος. ἔπειτα δοῦναι τινὶ ἀναθεῖναι ἐγγὺς τῆς πόλεως εἰς ὃ ἂν⁹ τύχῃ ἱερὸν ὡς
 16 εὐξάμενος.¹⁰ ὃν¹¹ δὲ δεῖ ἀναγνῶναι τὰ γεγραμμένα, χρῆ ἔλθόντα εἰς τὸ ἱερὸν καὶ γνόντα τὸ πινάκιον συσσήμῳ τινὶ προσυγκειμένῳ, ἀπενέγκαντα εἰς οἶκον θεῖναι εἰς ἔλαιον· πάντα οὖν τὰ γεγραμμένα φανεῖται.
 Πασῶν δὲ ἀδηλοτάτῃ πέμψις, πραγματωδεστάτῃ¹² δὲ νῦν μοι ἡ¹³ δι' ἀγραμμάτων¹⁴ ἐμφανισθήσεται·
 17 ἔστι δὲ τοιάδε. ἀστράγαλον εὐμεγέθη τρυπήσαι τρυπήματα¹⁵ εἴκοσι καὶ τέτταρα, ἕξ εἰς ἑκάστην

¹ Valckenaer: ἐπέθηκεν M: ἐπέτηξαν J. Afr.

² Meier: παρὸν δεῖ M.

³ Köchly and Rüstow: ἐκκνήσασ M: ἐκκινήσας J. Afr.

⁴ ὡτὺς αὖς M.

⁵ Kirchhoff: λέγεται M.

⁶ ἀκῆρωτον Hercher: ζωγραφικὸν Meier.

⁷ Meier: βούλει M.

⁸ Suggested by Diels. ⁹ Meier: εἶναι M.

¹⁰ Casaubon and Stahl: εὐξόμενος M: εὐξάμενον Meier.

¹¹ Meineke: ὅσον M. ¹² πραγματωδεστάτῃ M.

¹³ Added by Meineke. ¹⁴ Herm. Schone: διὰ γραμμάτων M.

¹⁵ J. Afr.: not in M.

of a tablet, poured wax over it, and written something else on the wax. Then when it came to the appointed person, he, scraping off the wax and reading the writing, again in the same way has sent back a message.¹ It would be possible, also, to write on a boxwood tablet with the best quality of ink, let it dry, and then by whitening the tablet to make the letters invisible. When, then, the tablet comes to the recipient, he should take it and put it into water; and so in the water there will clearly appear all that was written. You might also write on a tablet for a hero's chapel whatever you desire. Then it should be whitened and dried, and a light-bringing horseman painted on it, or anything else you please, with white apparel and his horse white; or if not white, any colour except black. Then it should be given to somebody, to be hung up near the city in whatever shrine he may chance upon, as though it were a votive offering. And he whose part it is to read the message must go to the shrine, and recognizing the tablet by some prearranged sign, must take it back home and put it into oil. And so everything written on it will become visible.

The most secret method of all for sending messages, but the most difficult, namely, that without writing, I shall now make clear. It is this.² In a sufficiently large astragal³ bore twenty-four holes, six

¹ This was done by Demaratus, the exiled Spartan king at the time of the expedition of Xerxes, as told by Herodotus vii. 239, whose account Aeneas follows closely here. Compare also Polyænus ii. 20; Justin ii. 10. 13 f.; A. Gellius xvii. 9. 16 f. for this stratagem.

² The detail with which Aeneas describes this device makes it certain that it was an invention of his own.

³ Astragals, or knuckle-bones of sheep, were often used like dice and were among the familiar playthings of children.

AENEAS TACTICUS

18 πλευρὰν τοῦ ἀστραγάλου· ἔστω δὲ τὰ τρυπή-
 ματα τοῦ ἀστραγάλου στοιχεῖα.¹ διαμνημόνευε¹
 δ'² ἀφ' ἧς ἂν πλευρᾶς ἀρξῆ³ τὸ ἄλφα καὶ
 τὰ ἐχόμενα ἄπερ ἐν ἐκάστη πλευρᾷ γέγραπται.
 μετὰ δὲ ταῦτα, ὅταν τινὰ θέλης ἐν αὐτοῖς
 τίθεσθαι λόγον, λίνον διεῖρειν, οἶον,⁴ ἐὰν θέλης
 Αἰνεῖαν⁵ δηλοῦν ἐν τῇ διέρσει⁶ τοῦ λίνου
 ἀρξάμενος ἐκ τῆς πλευρᾶς τοῦ ἀστραγάλου ἐν ἣ
 τὸ ἄλφα ἐστίν, διείρον,⁷ καὶ⁸ παρελθὼν τὰ ἐχόμενα
 τούτου⁹ παραγράμματα, ὅταν ἔλθης¹⁰ εἰς πλευρὰν
 οὐ τὸ ἰωτά¹¹ ἐστίν, διείρον πάλιν, παρεῖς δὲ τούτου
 τὰ ἐχόμενα, ὅπου συμβαίνει τὸ νῦ¹² εἶναι, διείρον¹³
 καὶ πάλιν παρεῖς τὰ¹⁴ ἐχόμενα τούτου, ὅπου τὸ¹⁵
 εἶ ἐστίν,¹⁶ διείρον τὸ λίνον,¹⁷ καὶ οὕτω τὰ ἐπίλοιπα
 τοῦ λόγου ἀντιγράφων ἔνειρε εἰς τὰ τρυπήματα,
 19 ὥσπερ ὁ ἄρτι ἐθέμεθα¹⁸ ὄνομα. ἔσται οὖν περὶ
 τὸν ἀστράγαλον ἀγαθὶς λίνου τετολοπευμένη,¹⁹
 δεῖσει δὲ τὸν¹ ἀναγιγνώσκοντα²⁰ ἀναγράφεσθαι
 εἰς δέλτον τὰ δηλούμενα γράμματα ἐκ τῶν τρυπη-
 μάτων. ἀνάπαλιν δὲ γίννεται ἢ ἕξερσις²¹ τῇ

¹ J. Afr. : not in M.

² δ' M : δὲ J. Afr.

³ ἀρξῆται J. Afr.

⁴ Köchly and Rüstow : λίνω διαίρειν ἐὰν M.

⁵ Haase (*Aineias* : *Aineian* Hercher : *Aineian* also is possible — R. Schöne) : εληδινη αλι M (with marks of corruption over the first η and the second ι).

⁶ Casaubon : διαίρεισει M.

⁷ Added by Williams.

⁸ Added by R. Schöne.

⁹ Hercher : τούτων M : τοῦ ἰωτα J. Afr. : τοῦ ἄλφα Köchly and Rüstow.

¹⁰ J. Afr. (ἐλθης) : ἐλθη M.

¹¹ Orelli : ουτο τω τα M : οὐ τὸ ἰωτα γράμμα J. Afr.

¹² Williams (ν̄ Orelli) : τον ειναι M (with mark of corruption over ε).

¹³ Köchly and Rüstow from J. Afr. διήρον.

on each side. Let the holes stand for letters, and note clearly on which side begins Alpha and the following letters that have been written on each particular side. Then, whenever you wish to communicate any word by them, draw a thread through them, as, for instance, if you wish to express *Αἰνεΐαν* by the drawing through of a thread, begin from the side of the astragal on which Alpha is found, pass the thread through, and omitting the characters placed next to Alpha, draw through again when you come to the side where Iota belongs; and disregarding the characters following this, again pass the thread through where Nu happens to be. And again passing by the succeeding letters draw the thread through where *Ei*¹ is found. Now continuing in this way to write the rest of the communication, pass the thread into the holes in such a manner as that in which we just now wrote the name. Accordingly, there will be a ball of thread wound around the astragal, and it will be necessary for the one who is to read the information to write down upon a tablet the characters revealed by the holes. The unthreading takes place in the reverse order to that of

¹ The original name for ε, whereas the name Epsilon is due to a later misunderstanding of Byzantine usage.

¹⁴ τὸν τὰ M.

¹⁵ Added by Köchly and Rüstow.

¹⁶ Haase: *ἔνεστιν* M.

¹⁷ R. Schöne thinks that directions for spelling the rest of the name are missing here, but the author may have stopped at this point after making the method clear.

¹⁸ Sauppe: *ὡσπερ αρ ται μεθα* M (with marks of corruption over the first ι and the second ε).

¹⁹ Herm. Schöne: *πεμπομένη* M.

²⁰ Hercher: *ἀναγινώσκοντα* M.

²¹ Boivin, Köchly and Rüstow: *ἐξίσεις* M.

AENEAS TACTICUS

- ἐνέρσει.¹ διαφέρει δὲ οὐδὲν τὰ γράμματα ἀνά-
 παλιν γραφήναι εἰς τὴν² δέλτον· οὐδὲν γὰρ ἦττον
 γνωσθήσεται. καταμαθεῖν δὲ πλείον³ ἔργον ἐστὶν
 20 τὰ γεγραμμένα ἢ τὸ ἔργον αὐτὸ γενέσθαι. εὐ-
 τρεπέστερον⁴ δ' ἂν τοῦτο γίγνοιτο ξύλου ὡς
 σπιθαμιαίου⁵ τρυπηθέντος ὅσα γε⁶ τὰ στοιχεῖα
 τῶν γραμμάτων· ἔπειτα ὡσαύτως ἐνείρειν τὸ
 λίνον εἰς τὰ τρυπήματα. ὅπου δ' ἂν εἰς τὸ αὐτὸ
 τρύπημα συμβῆ δις ἐνείρεσθαι, ὡσπερ τὸ αὐτὸ
 γράμμα δις ἐφεξῆς γράφεσθαι, προπεριελίξαντα
 τὸ λίνον περὶ τὸ ξύλον ἐνείρειν. γίγνοιτο δ'
 21 ἂν καὶ ὧδε. ἀντὶ τοῦ ἀστραγάλου καὶ ξύλου
 ποιήσαντα⁷ κύκλον ξύλινον λεᾶναι, καὶ τρηῆσαι
 ἐφεξῆς κύκλω τὰ στοιχεῖα τῶν γραμμάτων τέτταρα
 καὶ εἴκοσι· ὑποψίας δ' ἔνεκεν καὶ ἄλλα ἐν μέσῳ
 τοῦ κύκλου τρυπήσαι, ἔπειτα οὕτω εἰς τὰ στοιχεῖα
 22 ἐφεξῆς ὄντα τὸ λίνον ἐνείρειν. ὅταν δὲ δις τὸ
 αὐτὸ γράμμα συμβαίη⁸ γράφειν, ἐκ τῶν ἐν μέσῳ
 τρυπημάτων προενείραντα εἰς τὸ αὐτὸ γράμμα
 ἐνείρῃ· γράμμα⁹ δὲ λέγω τὸ τρύπημα.
 23 Ἦδη δὲ τινες εἰς τι¹⁰ βιβλίον γράψαντες ὡς
 λεπτότατον μακροῦς¹¹ στίχους καὶ λεπτὰ γράμματα,
 ἢ ὡς εὐογκοτάτη γένηται¹² ἢ ἐπιστολή, εἶτα ἐπὶ
 τῷ ὧμῳ τοῦ χιτῶνος ὑποθέντες καὶ ἀποπτύξαντες
 τοῦ χιτωνίσκου ἐπὶ τῷ ὧμῳ, ἀνύποπτος δὴ δοκεῖ

¹ Casaubon: ἐνέρξει M.

² Added by Hercher.

³ Orelli: πλείστον M.

⁴ Hercher: εὐπρεπέστερον M.

⁵ C: σπιθαμιαίου M.

⁶ Casaubon: ὅσατε M.

⁷ Hertlein: ποιήσας M.

⁸ Meier: συμβαίνει M.

⁹ Hercher: γράμματα M.

¹⁰ Köchly and Rüstow: τὸ M: εἰς βιβλίον J. Afr.

¹¹ μικροῦς one ms. of J. Afr. and Birt.

¹² J. Afr.: γίνηται M.

AENEAS THE TACTICIAN, xxxi. 19 – 23

the threading. But it makes no difference that the letters are written upon the tablet in reverse order, for none the less will the message be read, although to understand what has been written is a greater task than to prepare it. But this would be accomplished more easily if a piece of wood about a span long were perforated just as many times as there are letters in the alphabet, and the thread were then in the same way drawn into the holes. Wherever two insertions into the same hole occur, the same character being written twice in succession, you should wind the thread around the wood before inserting it. Or it could even be done as follows. Instead of the astragal or the piece of wood, make a disc of wood, polish it, and bore successively on the disc the twenty-four characters of the alphabet; but to avoid suspicion you should bore other holes also in the centre of the disc, and then in this way run the thread through the characters, which are in their regular order. But whenever the writing of the same letter occurs twice in succession, you must insert the thread in the holes bored in the centre of the disc before running it into the same letter; and by *letter* I mean the *hole*.¹

Again, some persons, after writing long lines with fine characters upon some very thin papyrus, so that the message may be as compact as possible, have then placed it on the shoulder of the tunic and spread a part of the over-tunic out on the shoulder. Naturally the transmitting of the letter is un-

¹ For a diagram and explanation see H. Diels, *Antike Technik*², 1920, 74-75.

AENEAS TACTICUS

- εἶναι ἢ κομιδὴ τῆς ἐπιστολῆς καὶ ἐνδεδυκότος τινὸς τὸν χιτωνίσκον καὶ οὕτω φερομένου.
- 24 Μαρτύριον δὲ ὅτι τὰ εἰσπεμπόμενα μετὰ ἐπιβουλῆς χαλεπὸν φυλάξαι. οἱ γοῦν περὶ Ἴλιον¹ ἄνθρωποι καὶ ἐκ τοσοῦτου χρόνου καὶ οὕτω διατεταμένοι² οὕτω³ δύνανται φυλάξαι μὴ εἰσελθεῖν αὐτοῖς τὰς Λοκρίδας· καίτοι τοσοῦτον αὐτοῖς ἔστιν ἢ σπουδὴ καὶ ἡ φυλακὴ. ἀλλ' ὀλίγοι, προσέχοντες τῷ λαθεῖν, λανθάνουσιν ἀνὰ ἔτεα⁴ πολλὰ εἰσάγοντες
- 25 σώματα. παρὰ δὲ τοῖς παλαιότεροις καὶ τοιούνδε ποτὲ ἐτεχνάσθη. Ποτίδαιαν γὰρ θέλων προδοῦναι Τιμόξενος Ἀρταβάζω προσυνέθεντο ἀλλήλοις ὁ μὲν
- 26 τῆς πόλεως τι χωρίον, ὁ δὲ τοῦ στρατοπέδου, εἰς ὃπερ ἐτόξευον πᾶν ὃ τι⁵ ἤθελον ἀλλήλοις ἐμφανίσει. ἐτεχνάζετο δὲ ᾧδε⁶. τοῦ τοξεύματος περὶ τὰς γλυφίδας⁷ ἐλίξαντες τὸ βιβλίον καὶ πτερώσαντες
- 27 ἐτόξευον εἰς τὰ προσυγκείμενα χωρία. ἐγένετο δὲ καταφανῆς ὁ Τιμόξενος προδιδούς τὴν Ποτίδαιαν· τοξεύων γὰρ ὁ Ἀρτάβαζος εἰς τὸ προσυγκείμενον, ἀμαρτῶν τοῦ χωρίου διὰ πνεῦμα καὶ φαύλην

¹ M has a space of four letters after this word.

² Hertlein: διατεταγμένοι M. ³ Casaubon: οὕτω M.

⁴ Orelli: ἀνετεα M (with sign of corruption over the first ε).

⁵ Herm. Schöne: ὅ τι ἀντι M.

⁶ Herm. Schöne: ἀξετο δὲ τοῦ M (with mark of corruption over the first ε).

⁷ Casaubon: πύλασ γλυφάσ M.

¹ This is the earliest of a long series of references in ancient authors to a singular custom whereby the Locrians sent annually for many centuries two maidens to the service of Athena at Ilium as an atonement for the injury done to Cassandra by Aias the Locrian. The inhabitants of the city were expected to prevent their introduction, killing those who were caught and burning their bodies. Only recently

suspected, if one puts on an over-tunic and wears it in this manner.

There is proof, however, of the fact that it is difficult to guard against anything sent in by artifice. At any rate the people at Ilium who have been so long and so well prepared, are not yet able to prevent the coming of the Locrian maidens¹ into their town, although they use such great care and watchfulness. But a few men, bent on deceiving, succeed in secretly bringing in many maidens, at yearly intervals.² And among the ancients the following scheme was once contrived. When Timoxenus wished to hand over Potidaea to Artabazus,³ they prearranged, the one a certain spot in the city, the other one in the camp, to which they used to shoot whatever they wished to communicate with each other. They adopted the device of winding a sheet of writing around the notched end of the arrow, and, after feathering it, they shot it into the places previously determined. But Timoxenus was discovered in the attempt to betray Potidaea. For Artabazus, shooting toward the designated area, missed the spot because of the wind and because the arrow was

a remarkable inscription has been discovered in West Locris which makes special provisions for the selection of the maidens. The best discussion at present of the whole matter is by A. Wilhelm, "Die lokrische Mädcheninschrift," *Jahresh. d. österr. arch. Inst.*, 1911, xiv. : 163-256.

² Possibly πολλά should be construed with έrea. The sense will then be: "have been secretly each year for many years bringing in maidens."

³ The incident is taken direct from Herodotus viii. 128. This device was often employed in ancient times, the best known case, perhaps, being that in which Caesar contrived in this way to get word to the beleaguered Quintus Cicero. Caesar, *Bell. Gall.* v. 48.

AENEAS TACTICUS

- πτέρωσι, βάλλει ἀνδρὸς Ποτιδαίου τὸν ὤμον, τὸν δὲ βληθέντα¹ περιέδραμεν ὄχλος, οἷα φιλεῖ γίνεσθαι ἐν τῷ πολέμῳ· αὐτίκα δὲ τὸ τόξευμα λαβόντες ἔφερον ἐπὶ τοὺς στρατηγούς, καὶ οὕτως
- 28 καταφανῆς ἐγένετο ἡ πράξις. Ἴστιαῖος δὲ βουλόμενος τῷ Ἀρισταγόρᾳ σημῆναι ἀποστήναι,² ἄλλως μὲν οὐδαμῶς εἶχεν ἀσφαλῶς³ δηλῶσαι, ἅτε φυλασσομένων τῶν ὁδῶν καὶ οὐκ εὐπορον ὄν⁴ γράμματα λαθεῖν φέροντα, τῶν δὲ⁵ δούλων τὸν πιστότατον ἀποξυρήσας ἔστιξεν καὶ ἐπέσχεν ἕως
- 29 ἀνέφυσαν⁶ αἱ τρίχες. ὡς δὲ ἀνέφυσαν⁷ τάχιστα, ἔπεμπεν εἰς Μίλητον, ἐπιστείλας τῷ ἐπεστιγμένῳ⁸ ἄλλο μὲν οὐδέν, ἐπειδὴν δ' ἀφίκηται εἰς Μίλητον πρὸς Ἀρισταγόραν, κελεύειν ξυρήσαντα κατιδεῖν εἰς τὴν κεφαλὴν. τὰ δὲ στίγματα ἐσήμαιεν ἅ ἔδει⁹ ποιεῖν.
- 30 Γράφειν δὲ καὶ ὧδε. προσυνηθέμενον τὰ φωνήεντα γράμματα ἐν κεντήμασι τίθεσθαι, ὅποσον δ'¹⁰ ἂν τύχῃ ἕκαστον ὄν,¹¹ ἐν τοῖς γραφομένοις
- 31 τοσαύτας στιγμὰς εἶναι. οἶον τόδε·

Διονύσιος κόλος¹²

Δ:::·N:::·C:::·C K:::·Λ:::·C

Ἑρακλείδας ἡκέτω

:·P·KΛ·:·:Δ·C·:·K·T:::·¹³

¹ Hercher (from Herodotus): *προβληθέντα* M.

² Added by Casaubon from Herodotus.

³ *ἀσφαλῶ* M.

⁴ Added by Valckenaer.

⁵ Added by Köchly and Rüstow.

⁶ Meier: *ἂν ἐφυσαν* M.

⁷ These three words added by Hercher from Herodotus.

⁸ Casaubon: *ἐπιστιγένω* M.

⁹ Meineke: *δεῖ* M.

¹⁰ Added by Hercher.

¹¹ Casaubon: *ὄν* M.

¹² Herm. Schöne: *καλός* M (*cf.* Introduction, p. 6): *καλῶς* Diels and Fischer.

badly feathered, and hit a man of Potidaea on the shoulder, and a crowd gathered around the wounded man, as often happens in war. And immediately picking up the arrow, they brought it to the generals, and thus the plot was revealed. Again, Histiaeus, wishing to tell Aristagoras to revolt,¹ had no other safe means of communicating, since the roads were guarded and it was not easy for a letter-carrier to escape notice, but shaving the head of his most faithful slave, he tattooed it and detained him until the hair had grown again. And as soon as it had grown, he dispatched him to Miletus and gave the tattooed man no other orders except that when he had come to Miletus, into the presence of Aristagoras, he should request him to shave his head and examine it, whereupon the marks indicated what was to be done.

But it is also possible to write as follows. It should be arranged in advance to express the vowels by dots, and whatever the number of each vowel happens to be, so many dots are to be placed in the writing. As for example the following:²

“ DIONYSIUS DOCKED ”

D : : : N : : : S : : : S D : : CK : D

“ LET HERACLEIDES COME ”

L : T H : R . C L : : : D : S C : : M :

¹ The story is from Herodotus v. 35.

² See Introduction, pp. 5-7.

¹⁸ In M only the consonants are given: Casaubon added the dots for the vowels. In this scheme the vowels from *a* to *ω* would bear the numbers one to seven. In English the correspondences will necessarily vary somewhat because of the different number and order.

AENEAS TACTICUS

- καὶ τότε ἄλλο· ἀντὶ τῶν φωνηέντων γραμμάτων τίθεσθαι ὃ τι δῆ.¹ καὶ τάδε· τὰ πεμποόμενα γράμματα εἰς τινα τόπον . . .² τῷ πεμπομένῳ δῆλον γίνεσθαι ἐλθόντος τοῦ ἀνθρώπου εἰς τὴν πόλιν καὶ πωλοῦντός τι ἢ ἄνουμένου, ὅτι ἤκει αὐτῷ γράμματα καὶ κεῖται ἐν τῷ προρρηθέντι³ τόπῳ. καὶ οὕτως οὔτε ὁ φέρων οἶδεν ὅτῳ ἠνέχθη οὔτε ὁ λαβὼν γνωστός ἐσται ὅτι ἔχει. πολλοὶ δὲ κατ' Ἡπειρον
- 32 κυσὶν ἐχρήσαντο ὧδε. ἀπαγαγόντες δέσμιον⁴ περιέθηκάν περὶ τὸν αὐχένα ἱμάντα, ἐν ᾧ ἐπιστολὴ ἐνέρραπτο.⁵ εἶτα ἀφήκάν νυκτὸς ἢ μεθ' ἡμέραν πρὸς ὃν ἐξ ἀνάγκης ἐμελλεν ἦξιν ὅθεν ἀπήχθη. ἔστι δὲ τοῦτο καὶ⁶ Θεσσαλόν.⁷
- 33 Χρῆ δὲ τὰς παραγινομένας εὐθύς ἀνοίγειν δέλτους. Ἀστυάνακτι δὲ τυράννῳ Λαμψάκου πεμφθείσης ἐπιστολῆς ἐν ἣ γεγραμμένα ἦν μηνύοντα τὴν ἐπιβουλήν ἀφ' ἧς ἀνηρέθη, παρὰ τὸ μὴ εὐθύς ἀνοῖξαι καὶ ἀναγνῶναι τὰ γεγραμμένα ἀλλὰ ἀμελήσαντος αὐτοῦ, πρὸς ἄλλοις δὲ γενομένου πρότερον, διεφθάρη, τὴν ἐπιστολὴν ἔχων περὶ τοὺς
- 34 δακτύλους. διὰ τὴν αὐτὴν αἰτίαν καὶ ἐν Θήβαις ἢ Καδμείᾳ κατελήφθη, τῆς τε Λέσβου ἐν Μυτιλήνῃ παραπλήσια τούτοις ἐπράχθη.

¹ Haase: τί δαι M.

² R. Schöne sets a lacuna here, suggesting the following: τῷ πεμπομένῳ γνωστὸν ἢ ἀνθρώπου κατατίθεσθαι γνωστοῦ καὶ αὐτοῦ, τῷ δὲ πεμπομένῳ δῆλον κτλ. The translation follows what seems most plausible in the suggestion, i.e., . . . ὑπ' ἀνθρώπου γνωστοῦ τῷ πεμπομένῳ δῆλον. Other (briefer) supplements require emendation as well.

³ Casaubon: πορρηθέντι M. ⁴ Casaubon: δεσμὸν M.

⁵ Köchly and Rüstow: ἐγγέραπτο M.

⁶ Added by Köchly and Rüstow.

⁷ J. Afr. (Θεσσαλόν): Θεσσαλονικόν M.

And here is another way: Instead of the vowels, put in anything whatever. And again, the following. The letter should be sent to a certain place [. . . by a man known to the recipient] and it should be indicated to him that a message has come for him and is in the appointed spot, by the fact that the man comes to the city and buys or sells something. And by this method neither does the bearer know to whom the message has been brought nor will the recipient be known as having the letter. Many in Epirus used to employ dogs in the following manner. After leading the dog away in leash they placed around his neck a strap, inside of which was sewed a letter. Then at night or during the daytime, they dispatched the dog to the person to whom he was sure to go, that is, to the one from whom he had been taken away. And this is also a Thessalian custom.

But the letters must be opened as soon as received. In fact Astyanax, tyrant of Lampsacus, did not at once open and read a letter sent to him in which was related evidence of the plot by which he was destroyed, but neglecting it, and attending first to other matters, he was killed while still holding the letter in his fingers.¹ For the same reason also the Cadmea in Thebes was captured,² and in Mytilene in Lesbos something similar happened.

¹ Nothing further is known of this Astyanax. The same thing happened to Julius Caesar. At the very moment when he was struck down he held in his hands a paper given him by Artemidorus which contained a full statement of the conspiracy.

² This was referred to also in Ch. xxiv. 18. The particular incident in the mind of the author was, no doubt, the occasion when Archias, the oligarchic leader, was given a paper

AENEAS TACTICUS

35 Γλοῦς δὲ βασιλέως ναύαρχος παρὰ βασιλέα ἀναβάς, ἐπεὶ οὐχ οἶόν τε ἦν ὑπομνήματα ἐν βιβλίῳ ἔχοντα εἰσιέναι παρὰ βασιλέα (ἦν δὲ αὐτῷ περὶ πολλῶν τε καὶ μεγάλων διαμνημονευτέον), ἐγράψατο εἰς τὰ διαστήματα τῆς χειρὸς τῶν δακτύλων περὶ ὧν ῥητέον ἦν αὐτῷ.

Περὶ τὴν τῶν τοιούτων ἐπιμέλειαν τῷ πυλωρῷ πονητέον,¹ ὡς ἂν μηδὲν² λανθάνῃ³ εἰς τὴν πόλιν εἰσφερόμενον μήτε ὄπλον μήτε γράμματα.

XXXII. [Ἀντιμηχανήματα]

Πρὸς δὲ τὰς τῶν ἐναντίων προσαγωγὰς μηχανήμασιν ἢ σώμασιν ἐναντιοῦσθαι ὧδε. πρῶτον μὲν εἰς τὰ ὑπεραιρόμενα ἐκ πύργων ἢ ἰστών⁴ ἢ τῶν ὁμοτρόπων τούτοις ἰστία,⁵ οἷς τὰ⁶ προσαχθέντα ὑπεραίρειν⁶ χρή, τισὶν ἀδιατμήτοις περιβληθέντα κατατετάσθαι ὑπὸ τενόντων.⁷ ἄλλα τε⁸ καὶ ὑποθυμῶν καπνὸν πολὺν ἰέντα⁵ καὶ⁵ ὑφάπτειν ὡς μέ-

¹ Herm. Schöne: ποιητέον M.

² μηθὲν M.

³ L. Dindorf: λανθάνηται M.

⁴ Casaubon: ἰστίων M.

⁵ Added by Köchly and Rüstow.

⁶ Köchly and Rüstow: ὑπεραιρατο M.

⁷ Köchly and Rüstow: ὑπονεόντων M.

⁸ Köchly and Rüstow: δὲ M.

telling about the design on his life, while sitting at table the evening of the night on which he was murdered. He thrust the paper under a cushion with the remark "Serious business to-morrow."

AENEAS THE TACTICIAN, xxxi. 35 – xxxii. 1

Glus,¹ the admiral of the great king, came up before the king, and since it was forbidden to come into the king's presence with a sheet of notes (and he had to report upon many important affairs), he wrote in the spaces between the fingers of his hands the things he had to say to the king.

The gate-keeper ought to be watchful about such matters as these, so that nothing brought into the city may escape him, whether it be weapon or message.

XXXII. [*Counter-devices*]

Against the approaches of the foe you must take the following measures with engines or with infantry.² In the first place, against objects raised higher than the wall from towers or masts or devices similar to these, there should be stretched on thongs and covered with some impenetrable substance sails which will have to be overshoot by the missiles. And in particular one must set smoking materials that will send up a great smudge from beneath, and must kindle those which will rouse as great a blaze

¹ Glus (the correct form is Glos) is well known from the *Anabasis* as one of those who supported the younger Cyrus in the revolt against his brother. He was admiral of the great king's forces in the war against Evagoras of Cyprus, between 387-6 b.c. and 380-79, the year in which he was murdered.

² In this chapter there are many echoes of the devices employed by the Spartans in the long siege of Plataea, 428-7 b.c., which seems to have made an epoch in ancient siege operations. A full account of the events at Plataea is given by Thucydides ii. 75-8.

AENEAS TACTICUS

2 γιστον πῦρ πνέοντα· ἀνταίρεσθαι πύργους ξυλίνους
 ἢ ἄλλα ὕψη ἐκ φορμῶν πληρουμένων ψάμμου ἢ ἐκ
 λίθων ἢ ἐκ πλίνθων. ἴσχοιεν¹ δ' ἂν τὰ βέλη καὶ²
 καλάμων ταρσοὶ ὀρθίων καὶ πλαγίων συντιθεμένων.
 3 ἤτοιμάσθαι³ δὲ καὶ τοῖς εἰς τὰ χεῖλη μηχανήμασιν
 εἰσπίπτουσιν⁴ κριῶ καὶ τοῖς ὁμοτρόποις τούτῳ,⁵
 ἐρύματα, σάκκους ἀχύρων πληροῦντα προκρεμαν-
 νύειν⁶ καὶ⁷ ἀγγεῖα ἐρίων καὶ ἀσκούς βοείους
 νεοδάρτους πεφουσημένους ἢ πεπληρωμένους⁸ τινῶν
 4 καὶ⁹ ἄλλα τούτοις ὁμότροπα. καὶ ὅταν ἢ πύλην ἢ
 ἄλλο τι τοῦ τείχους διακόπτη, χρῆ βρόχῳ τὸ προῖ-
 σχον¹⁰ ἀναλαμβάνεσθαι, ἵνα μὴ δύνηται προσπίπτειν
 5 τὸ μηχανήμα. καὶ παρασκευάζεσθαι δὲ ὅπως
 λίθος ἀμαξοπληθῆς ἀφιέμενος ἐμπίπτῃ καὶ συντρίβῃ
 τὸ¹¹ τρύπανον· τὸν δὲ λίθον ἀφίεσθαι ἀπὸ τῶν
 6 προωστῶν, ἐχόμενον ὑπὸ καρκίνων. ὅπως δὲ μὴ
 ἀμαρτάνῃ τοῦ τρυπάνου ὁ λίθος φερόμενος, κάθετον¹²
 χρῆ προαφίεσθαι, καὶ ὅταν αὕτη πέσῃ ἐπὶ τὸ τρύπα-
 7 νον, εὐθὺ τὸν λίθον ἐπαφίεσθαι. ἀριστον δὲ πρὸς
 τὰ διακόπτοντα τὸ τεῖχος καὶ τότε παρεσκευάσθαι.
 ὅταν γνῶς ἢ¹³ προσάγεσθαι τοῦ τείχους, ταύτῃ χρῆ
 ἔσωθεν ἀντιπαρασκευάζειν ἀντίκριον, διορύξαντα
 τοῦ τείχους μέχρι τοῦ ἄλλου μέρους τῶν πλίνθων,¹⁴
 ἵνα μὴ προῖδωσιν πρότερον οἱ πολέμιοι· ὅταν δὲ
 ἐγγὺς ἦ τὸ διακόπτον, οὕτως ἔσωθεν τῷ ἀντικρίῳ

¹ Hertlein: ἴσχοι M.

² Added by R. Schöne (Köchly and Rüstow).

³ Hertlein: ἤτοιμάσθαι M.

⁴ Casaubon: εἰσποῦσιν M.

⁵ Hertlein: τούτων M.

⁶ Casaubon: προκρεμαννύειν M.

⁷ Added by Köchly and Rüstow.

⁸ Casaubon: πεπληρωμένων M.

as possible, and build in opposition wooden towers, or other high structures with baskets filled with sand, or built of stones or bricks. And even basket-work made of reeds, upright and transverse, woven together, may stop the missiles. Against contrivances for attacking the battlements, such as a ram or other like instrument, you must also make ready protective devices to hang in front of them, sacks full of chaff, and bags of wool, fresh hides inflated or filled with something, and other things similar to these. And when the ram is battering a gate or some other part of the wall, you must catch up with a noose the projecting part of the engine, so that it cannot strike again. And you must make ready a stone large enough to fill a wagon so that it may be let fall upon the drill and crush it. The stone, held in place with grappling hooks, must be dropped from the projecting beams, and in order that in its descent it may not miss the drill, a plumb-line should be lowered in advance, and when it hangs over the drill, then the stone should at once be dropped after it. It is best to adopt this measure also against the engines that are battering the wall: When you see what part of the wall is being attacked, you should prepare a counter-ram at that point, inside the wall, and excavate the wall just as far as the outer layer of bricks, so that the enemy may not be aware in advance. And when the ram is close at hand you must strike from within with the counter-ram, which must

⁹ Added by Hercher: ἡ Köchly and Rüstow.

¹⁰ Casaubon: προστόχον M.

¹¹ Casaubon: τὸν M.

¹² Hercher: καθέτην M. ¹³ Köchly and Rüstow: ἡ M.

¹⁴ Casaubon: τὸν πλινθον M.

AENEAS TACTICUS

- παίειν· και πολὺ ἰσχυρότερον ὁ ἀντίκριος γίνεσθαι.¹
- 8 πρὸς δὲ τὰ μεγάλα μηχανήματα, ἐφ' οἷς σώματά τε πολλὰ προσάγεται και βέλη ἐξ αὐτῶν ἀφίεται ἄλλα τε και καταπάλται² και σφενδόνας, εἰς δὲ τὰς ὀροφίνας οἰκίας και πυρφόρα τοξεύματα, πρὸς δὲ ταῦτα τὰ μηχανήματα πρῶτον μὲν χρή τοὺς ἐν τῇ πόλει κρυφαίως ὑπορύσσειν κατὰ τὰς προσαγωγὰς τοῦ μηχανήματος, ἵνα οἱ τροχοὶ τῶν μηχανημάτων ἐμπίπτοντες δύνωσιν εἰς τὰ ὑπορύγματα· ἔπειτα ἔσωθεν ἀνταίρειν ἐκ φορμῶν πληρουμένων³ ψάμμου και λίθων ἐκ τῶν ὑπαρχόντων ἔρυμα, ὅπερ τοῦ τε μηχανήματος ὑπερέξει και τὰ ἐκ τῶν ἐναντίων βέλη
- 9 ἀργὰ ποιήσει. προκαλύπτειν δὲ ἅμα τούτοις και πυκνὰ⁴ παραπετάσματα ἢ ἰστία, ἔρύματα τῶν εἰσαφιεμένων βελῶν, ἅπερ σχήσει τε τὰ ὑπερπίπτοντα τῶν βελῶν, και ραδίως συλλεγήσεται,
- 10 χαμαιπετές δὲ μηδὲν ἔσται. τὸ δὲ αὐτὸ ποιεῖν και ἢ ἂν ἄλλη τοῦ τείχους ὑπερπετῆ γιγνόμενα τὰ βέλη τοὺς ὑπηρετοῦντάς τε και τοὺς διαπορευομένους
- 11 βλάβη και τιτρώσκη.⁵ ἢ δὲ ἂν τοῦ τείχους χελώνη προσαχθεῖσα δύνηται⁶ τι τοῦ τείχους διορύξαι ἢ καταβαλεῖν, ταύτη χρή ἀντιοῦσθαι
- 12 παρεσκευασμένον. πρὸς μὲν τὸ διόρυγμα πῦρ ποιεῖν πολὺ, πρὸς δὲ τὸ πέσημα τοῦ τείχους τάφρον ἔσωθεν ὀρύσσειν, ἵνα μὴ εἰσέλθωσιν· και ἅμα ἀνταίρειν τειχίον⁷ τειχίζοντα πρότερον ἢ πεσεῖν τὸ τείχος, ἢ⁸ διορύσσεται, ἂν μὴ ἄλλως δύνῃ κωλύειν.

¹ Capps: γίνεται M.

² R. Schöne: καταπέλται M.

³ Casaubon: πληρουμένου M. ⁴ Th. Mommsen: γυμνά M.

⁵ Haase: βλάβη και τιτρώσκει M.

⁶ Haase: δινῆσεται M.

⁷ Added by Meineke.

⁸ ἢ M.

be much more powerful. Furthermore, against the large engines on which many troops are moved up, and from which missiles are shot, and especially catapults and slings, and incendiary arrows against the thatched roofs—against all these, I say, those in the city must, in the first place, secretly dig beneath where the engine is to be applied, so that the wheels of the engines may sink and fall into the excavations. Then, on the inside, you must build a defence of baskets of sand and of stones from what you have near by, which will overtop the engine and render the missiles of the enemy useless. At the same time you must spread out from the inside of the wall thick curtains or sails as a protection from the oncoming shafts, which will stop the missiles that fall over the wall, so that they will be easy to gather up and none will fall to the ground. The same must be done at any other part of the wall where the missiles might come over and injure or wound the helpers and passers-by. And at whatever part of the wall by bringing up a pent-house a portion of the wall can be dug through or broken down, there counter-preparation must be made. To forestall the piercing of the wall a large fire should be built, and to provide against a breach of the wall a trench must be dug inside, so that the enemy may not enter. At the same time you should build a counter-rampart where the breach is being made, before the wall collapses, if you cannot otherwise stop the enemy.

AENEAS TACTICUS

XXXIII. [Ἐμπρησις]

Χρῆ δὲ ταῖς προσενεχθείσαις χελώναις ἐπιχεῖν πίσσαν καὶ στυππεῖον¹ καὶ θείον ἐπιβάλλειν, ἔπειτα φλογωθέντα² φάκελλον καὶ ἐξάψαντα ἐπαφιέναι σχοίνῳ ἐπὶ τὴν χελώνην. τὰ δὲ τοιαῦτα προτεινόμενα³ ἀπὸ τοῦ τείχους ἐπιβάλλεται τοῖς προσαγομένοις μηχανήμασι. πιμπράναι χρῆ ταῦτα² ὡδε. παρεσκευάσθω ξύλα οἷον ὕπερα, μεγέθει⁴ δὲ πολλῶ μείζω· καὶ εἰς μὲν τὰ ἄκρα τοῦ ξύλου κρούσαι σιδήρια ὀξέα μικρότερα⁵ καὶ μείζω, περὶ δὲ τὰ ἄλλα μέρη τοῦ ξύλου καὶ ἄνω καὶ κάτω χωρὶς πυρὸς σκευασίας ἰσχυράς· τὸ δὲ εἶδος γενέσθω οἷον κεραυνὸς τῶν γραφομένων.⁶ τοῦτο δὲ ἀφίεσθαι χρῆ ἐς τὸ προσαγόμενον μηχανήμα ἐσκευασμένον οὕτως ὥστε ἐμπήγνυσθαι εἰς τὸ μηχανήμα, καὶ ἐπιμένειν τὸ πῦρ ἐμπά-
³ γέντος αὐτοῦ. ἔπειτ' ἂν τινες ὡσι τῆς πόλεως ξύλινοι μόσυνες ἢ τοῦ τείχεός τι, χρῆ τούτοις ὑπάρχειν πρὸς τὸ μὴ ἐμπίμπρασθαι⁷ ὑπὸ τῶν πολεμίων πέλους⁸ καὶ βύρσας πρὸς τὴν ἔπαλξιν⁹.
⁴ ἐὰν δὲ ἐμπρησθῶσιν πύλαι, προσφέρεσθαι ξύλα, καὶ ἐμβάλλοντα ὡς μέγιστον τὸ πῦρ ποιεῖν, μέχρι οὗ ἂν¹⁰ ταφρεύσης¹¹ τὰ ἔσωθεν, καὶ ἀντιδείμης¹² ἐκ τῶν σοι συνυπαρχόντων¹³ τάχιστα· εἰ δὲ μή, ἐκ τῶν ἐγγύτατα οἰκιῶν καθαιρούντα.

¹ Casaubon: στίππιον M.

² φλογώσαντα J. Afr., Hercher.

³ Boivin (after Casaubon): προτεινόμενος M.

⁴ Gronov and Köchly and Rüstow: ὑπερμεγέθη M.

⁵ Suggested by R. Schöne. ⁶ Hertlein: τὸ γραφόμενον M.

⁷ Köchly and Rüstow: ἐμπίμπρασθαι M. ⁸ Koraes: πλείους M.

⁹ Köchly and Rüstow: τάξιν. ¹⁰ Added by Meineke.

¹¹ Boivin, Hertlein: ταφρεύση M.

XXXIII. [*Setting on Fire*]

You must pour pitch and cast tow and sulphur on the pent-houses that have been brought up, and then a fagot fastened to a cord must be let down in flames upon the pent-house. And such things as these, held out from the walls, are hurled at the engines as they are being moved up, by which the latter are to be thus set on fire. Let sticks be prepared shaped like pestles¹ but much larger, and into the ends of each stick drive sharp irons, larger and smaller, and around the other parts of the stick, above and below, separately, place powerful combustibles. In appearance it² should be like bolts of lightning as drawn by artists. Let this be dropped upon the engine as it is being pushed up, fashioned so as to stick into it, and so that the fire will last after the stick has been made fast. Then, if there are any wooden towers, or if a part of the wall is of wood, covers of felt or raw hide must be provided to protect the parapet so that they cannot be ignited by the enemy. If the gate is set on fire you must bring up wood and throw it on to make as large a fire as possible, until a trench can be dug inside and a counter-defence be quickly built from the materials you have at hand, and if you have none, then by tearing down the nearest houses.

¹ The pestle meant by the word *ὑπερον* here is the large instrument (three cubits long according to the advice of Hesiod, *Works and Days*, 423) used to stir the meal or dough in the large kneading-trough.

² That is, the end of the pestle, bristling with iron points.

¹² R. Schöne: *ἀν τι δέη* M (cf. xxiii. 5 and xxxii. 12).

¹³ *ὑπαρχόντων* J. Afr.

AENEAS TACTICUS

XXXIV. [Πυρὸς σβεστήρια πρὸς τὰ ἐμπιμπράμενα]

Ἐὰν δέ τι οἱ πολέμοι πειρῶνται ἐμπιμπράναι ἰσχυρᾷ σκευασίᾳ πυρός, σβεννύειν¹ χρή αὐτὸ ὄξει· οὐ γὰρ ἔτι ραδίως² ἐξάπτεται. μᾶλλον δὲ ἰξῶ³ προαλείφειν· τούτου γὰρ πῦρ οὐχ ἄπτε-
2 ται. τοὺς δὲ κατασβεννύντας ἀπὸ τῶν ὑψηλο-
τέρων ἔχειν περὶ τὸ πρόσωπον ἔρυμα, ἵνα ἦσσαν
ὀχλῶνται προσαϊσσοῦσης αὐτοῖς τῆς φλογός.

XXXV. [Πυρὸς σκευασία]

Αὐτὸν δὲ πῦρ σκευάζειν ἰσχυρὸν ὦδε, ὅπερ οὐ
πάνυ τι⁴ κατασβέννυται. πίσσαν, θείον, στυπ-
πεῖον,⁵ μάνναν λιβανωτοῦ, δαδὸς πρίσματα ἐν
ἀγγείοις⁶ ἐξάπτοντα προσφέρειν, ἐὰν βούλη⁷
τῶν πολεμίων τι ἐμπρησθῆναι.

XXXVI. [Κλιμάκων προσθέσει κωλύματα]

Ταῖς δὲ τῶν κλιμάκων προσθέσειν ἀντιοῦσθαι
ὦδε.⁸ ἐὰν μὲν ὑπερέχη τοῦ τείχους ἢ κλιμαξ
προστεθεισα, χρή, ὅταν ἐπ' ἄκρων ἢ ὀ⁹ ἀναβαί-

¹ R. Schöne and Lange using some older conjectures: τινες πολέμοι παί (with mark of corruption over ι) . . .
ται ἐμπιμπράμενα ἰσχυραὶ σκευασίαι πρὸς τὸ πῦρ σβεννύειν M.

² C: ράϊωσ M.

³ Added by Meineke: δξος J. Afr. and Polyænus vi. 3.

⁴ Meineke: πάντη > πάνυτη M.

⁵ στυπεῖον M.

⁶ Orelli: ἐναντίως M.

⁷ Hertlein: βούλει M.

⁸ Added by Hercher.

⁹ Added by Köchly and Rüstow.

XXXIV. [*Fire-extinguishers*]

If the enemy tries to set anything on fire with a powerful incendiary equipment you must put out the fire with vinegar, for then it cannot easily be ignited again, or rather it should be smeared beforehand with birdlime,¹ for this does not catch fire. Those who put out the fire from places above it must have a protection for the face, so that they will be less annoyed when the flame darts toward them.

XXXV. [*Incendiary Equipment*]

And fire itself which is to be powerful and quite inextinguishable is to be prepared as follows. Pitch, sulphur, tow, granulated frankincense, and pine sawdust in sacks you should ignite and bring up if you wish to set any of the enemy's works on fire.

XXXVI. [*How to Prevent the Placing of Ladders*]

The placing of ladders must be prevented thus. If the ladder when in place overtops the wall, you must, when the person who mounts it is at the top,

¹ This word is omitted in the original, but despite Julius Africanus and Polyænus vi. 3, who write *δξος*, birdlime is certainly meant, partly because vinegar has already been mentioned, and partly because 'smear' (*προαλείφειν*) is appropriately used only of a substance like birdlime, certainly not of a liquid like vinegar. Philo Mechanicus v. 90. 17 (Schöne) mentions birdlime as one of the important objects with which to be supplied in case of a siege, and (99. 26 ff.) recommends that wood which is in danger of being set on fire be smeared with birdlime or a mixture of blood and ashes. Thus Theophrastus also, *De igne* 61, notes that things smeared with birdlime do not take fire; cf. Pliny, *N.H.* xxxiii. 94.

AENEAS TACTICUS

νων, τότε ἀπῶσαι τὸν ἄνδρα ἢ τὴν κλίμακα ξύλω
 δικρῶ, εἰ μὴ ἄλλως κωλύειν δύνη διὰ τὸ ὑποτο-
 2 ξεύεσθαι· εἰ δὲ ἀρτία ἢ¹ τῷ τείχει² ἢ κλίμαξ,
 τὴν μὲν κλίμακα οὐχ οἶόν τε ἀπωθεῖν, τὰ δὲ
 ὑπερβαίνοντα χρή ἀπῶσαι. εἰ δὲ ταῦτα μὲν
 ἀδύνατα³ δοκῆ εἶναι, πεποιῆσθαι χρή οἶον θύραν
 ἐκ σανίδων, ἔπειτ' ἐπὶ προσφέρηται ἢ κλίμαξ,
 προὔποτιθέναι⁴ τῇ κλίμακι τῇ προσφερομένῃ· ὅταν
 δὲ προσίῃ ἢ κλίμαξ πρὸς τὴν θύραν, ἐξ ἀνάγκης
 ὑπαχθείσης τῆς θύρας ἢ κλίμαξ πίπτει, σπονδύλου
 προὔποτιθεμένου, οὐδὲ προσσταθῆναι⁵ δυνήσεται.

XXXVII. [Ἐπορυσσόντων γνῶσις καὶ κώλυσις]

Τοὺς δὲ ὑπορύσσοντας ᾧδε κωλύειν. εἰ δο-
 κῆς⁶ ὑπορύσσεσθαι, ὡς βαθυτάτην ἐκτὸς χρή
 τὴν τάφρον ὀρύσσεσθαι, ὅπως εἰς τὴν τάφρον τὸ
 ὑπόρυγμα ἀφίκηται καὶ οἱ ὑπορύσσοντες ὀφθῶσιν.
 2 εἰ δὲ σοι ὑπάρχη, καὶ τειχίον τειχίσαι εἰς αὐτὴν
 ὡς ἰσχυροτάτων⁷ καὶ μεγίστων λίθων. εἰ δὲ
 3 δὲ μὴ ὑπάρχη τειχίσαι λίθοις,⁸ ξύλων φορυτὸν
 κομίσαντα . . .⁹ ἂν δὲ τὰ ὑπορύγματα τῆς τά-
 φρου πῆ¹⁰ προσπέση, ταύτῃ ἐπιβάλλοντα¹¹ ξύλα
 καὶ τὸν φορυτὸν ἐμπρῆσαι καὶ τὰ ἄλλα κατα-
 σκεπάσαι, ὅπως ὁ καπνὸς εἰς τὸ διόρυγμα πο-
 ρεύσῃται καὶ κακῶς ποιήσῃ¹² τοὺς ἐν τῷ ὀρύγματι

¹ Meineke: ἀρ τι ἀνη M.

² Orelli: τω τε σχει M (with mark of corruption over σ).

³ Added by Casaubon. ⁴ Hertlein: ὑποπροτιθέναι M.

⁵ R. Schöne: προσσταθῆναι M.

⁶ δοκῆ J. Afr., C, Casaubon, Hercher

⁷ J. Afr.: ἰσχυροτάτην M. ⁸ J. Afr.: λίθους M.

⁹ R. Schöne recognizes a lacuna here.

thrust him or the ladder away with a forked pole, if you cannot keep him away otherwise because of arrows shot from below. And if the ladder is even with the wall it cannot be pushed away, but those who climb over the wall should be thrust off. And if even this seems impossible, there must be made a sort of door-frame of planks and when the ladder is being raised, the frame should be placed in advance underneath it. When, then, the ladder approaches the frame, at the raising of the frame from beneath, if a roller has previously been attached to the edge of it, the ladder necessarily falls, and it will not be possible to set it up.

XXXVII. [*Detection and Prevention of Mining Operations*]

Those who are constructing mines are to be prevented in the following manner. If you think a mine is being made you should dig the moat outside the wall as deep as possible so that the mine may open into the moat and those who are digging it may be exposed to view. And if you have a chance, a wall should also be built in the moat, of the very hardest and largest stones available. But if you have no chance to build a stone wall you should bring up logs and rubbish . . . , and if the mines at any point open into the moat, there you should dump the wood and set fire to the rubbish and cover the rest over in order that the smoke may penetrate the opening and injure those in the mine. It is

¹⁰ Added by Meineke.

¹¹ Köchly and Rüstow: ἐπιβάλλοντες M., ἐμβάλλοντας J. Afr.

¹² R. Schöne: ποιήσῃ M.

AENEAS TACTICUS

ὄντας· ἐνδέχεται δὲ καὶ πολλοὺς ἀπολέσθαι
 4 αὐτῶν ὑπὸ τοῦ καπνοῦ. ἤδη δέ τινες καὶ σφή-
 κας¹ καὶ μελίσσας εἰς τὸ διόρυγμα ἀφέντες
 5 ἐλυμήναντο τοὺς ἐν τῷ ὀρύγματι ὄντας. χρή δὲ
 ἀπλῶς εἰπεῖν² καθ' ὃν τινα τόπον³ ὀρύσσουσιν
 ἀνθυπορύσσειν καὶ ἀντιοῦσθαι καὶ ἐμπιμπράναι
 6 . . .⁴ τὸ ἐν τῷ ὀρύγματι μαχόμενον. παλαιὸν
 δέ τι λέγεται . . .⁵ Ἀμασιν Βαρκαίους πολιορ-
 κοῦντα,⁶ ἐπεὶ ἐπεχείρει ὀρύσσειν. οἱ δὲ Βαρκαῖοι
 αἰσθόμενοι τὸ⁷ ἐπιχείρημα τοῦ Ἀμάσιδος, ἤπο-
 ροῦντο μὴ λάθῃ ἢ φθάσῃ, ἔπειτα ἀνὴρ χαλκεὺς
 ἀνεῦρεν ἐνθυμήσας· ἀσπίδος χάλκωμα περιφέρων⁸
 ἐντὸς⁹ τοῦ τείχεος ἐπάνω προσίσχεν¹⁰ πρὸς τὸ
 7 δάπεδον.¹¹ τῇ μὲν δὴ ἄλλῃ κωφά ἦν πρὸς ἃ
 προσίσχοι τὸ χάλκωμα· ἢ δὲ ὑπωρύσσετο,¹²
 ἀντήχει. ἀντορύσσοντες οὖν οἱ Βαρκαῖοι ταύτη,
 ἀπέκτειναν πολλοὺς τῶν ὑπορυσσόντων. ὅθεν καὶ
 νῦν χρῶνται τούτῳ τῷ ἐνθυμήματι¹³ γνωρίζοντες
 ἢ ὑπορύσσεται.
 8 Καὶ οἷς μὲν προσήκει¹⁴ τὰ¹⁵ ἐκ τῶν ἐναντίων
 τεχνάσματα καταντῶντα¹⁶ ἀμύνειν¹⁷ δεδήλωται·
 τοῖς δὲ ὑπορύσσειν μέλλουσιν ὧδ' ἂν γένοιτο
 9 ἰσχυρότατον φράγμα. χρή δύο ἀμαξῶν τοὺς ῥυ-
 μούς εἰς τὸ αὐτὸ δῆσαι, συμπετάσαντα κατὰ τὸ

¹ Casaubon: σφίκασ M.

² Herm. Schöne: αγνωσσειν M.

³ J. Afr.: τρόπον M.

⁴ For the lacuna which he recognizes here R. Schöne suggests φορντὸν καὶ οὕτω διαφθείρειν τὸ κτλ.

⁵ The lacuna is indicated by Rouse.

⁶ Casaubon: πολιορκοῦντας M.

⁷ Added by C.

⁸ Köchly and Rüstow (from Herodotus): ἐπιφέρων M.

⁹ Wesseling: ὄντος M.

¹⁰ Casaubon: προσίσχεν M.

¹¹ Wesseling (from Herodotus): τάδε M.

even possible that many of these may be killed by the smoke. And in some instances, by releasing wasps and bees into the opening, men have worked mischief with those in the mine. One must, in a word, at whatever point the enemy are digging, construct a countermine beneath and against them, and by setting fire to [rubbish in the countermine thus destroy the] fighting force in the mine itself. Now an old incident is told . . . of Amasis in his siege of Barca, when he was trying to dig a mine.¹ The people of Barca, who were aware of the attempt of Amasis, were concerned lest he might elude or anticipate them, until a coppersmith thought out a device. Carrying a bronze shield around inside the wall he held it against the ground above various points. And of course at all other points the parts to which he applied the bronze were without sound, but where the digging was in progress beneath the shield became resonant. So the people of Barca dug a countermine at this point and killed many of the enemy's miners, and as a result even now men use this means of ascertaining where mines are being dug.

I have already explained by what means one should oppose and ward off the devices of the enemy. For those, on the other hand, who are to construct mines, a very effective form of protection would be this. One should fasten together the poles of two wagons, having first turned them back each in the

¹ The incident is taken from Herodotus iv. 200.

¹² Casaubon: ὑπορυσσεται M.

¹³ Hertlein: αὐτῷ ἐν τῇ νυκτὶ M.

¹⁴ Hertlein: προσήκεν M.

¹⁵ Casaubon: καὶ M.

¹⁶ R. Schöne: καὶ ἀντιωμεθα M.

¹⁷ C: ἀμύνη M.

AENEAS TACTICUS

ἕτερον μέρος τῆς ἀμάξης, ὅπως μετεωρισθῶσιν οἱ ῥύμοι εἰς τὸ αὐτὸ νεύοντες· ἔπειτα οὕτως¹ ἐπισυνδεῖν ἄλλα ξύλα καὶ ρίπους καὶ ἄλλα φράγματα ἐπάνω, ταῦτα² δὲ πηλῶ καταλείψαι. ἔσται οὖν τοῦτο καὶ προσαγαγεῖν ὅπου βούλει τοὺς τροχοὺς καὶ ἀπαγαγεῖν, ὑπὸ δὲ τούτῳ τῷ φράγματι τοὺς ὑπορύσσοντας εἶναι.

XXXVIII. [Ἐπικουρητικά]

Ἐν δὲ ταῖς προσβολαῖς τῶν πολεμίων πρὸς τὸ τεῖχος μηχανήμασιν ἢ καὶ σώμασι χρῆ διατετάχθαι τοὺς ἐν τῇ πόλει μαχομένους τρία μέρη, ὅπως οἱ μὲν μάχωνται, οἱ δὲ ἀναπαύωνται, οἱ δὲ παρασκευάζωνται, καὶ νεοκμητες³ αἰεὶ ἐπὶ τοῦ τεύχους ὦσιν.⁴ δεῖ δὲ τινας καὶ ἄλλους ἐπιλελεγμένους πλήθει πλείονι μετὰ τοῦ στρατηγοῦ ξυμπεριμέναι κύκλῳ τὸ τεῖχος, ἐπικουροῦντας αἰεὶ τινι πονουμένῳ μέρει· τὸ γὰρ ἐπιὸν μᾶλλον οἱ πολέμιοι φοβοῦνται τοῦ ὑπάρχοντος καὶ παρόντος ἤδη. τὰς τε κύνας δεσμεῖν τὸν³ καιρὸν τοῦτον· μετὰ γὰρ ὄπλων καὶ θορύβου τῶν ἀνθρώπων⁵ τρεχόντων κατὰ τὴν πόλιν δι'

¹ J. Afr.: ὅπως M.

² Köchly and Rüstow: σπανιώτατα M: ἐπάνω, τὰ J. Afr.

³ Casaubon: νεοκμητες M. ⁴ Casaubon: σώμασιν M.

⁵ Haase: θορυβοῦντων καὶ ἀνθρώπων M.

¹ Apparently the poles, which seem to have been hinged at the point of attachment, are thought of as being turned (or 'spread back' συμπετάννυμι) in a direction which eventually would bring them back upon the body of the wagon

direction of the other part of its wagon, in such a way that the poles may be raised aloft, inclining toward the same point.¹ Then when this has been done, one should fasten on in addition other timbers and hurdles and other sorts of covering above and smear these over with clay. This device, then, can be advanced and withdrawn on its wheels wherever you desire, and those who are excavating can keep under this protection.

XXXVIII. [*Use of Reserves*]

During the attacks of the enemy upon the wall with engines of war, or even with infantry, the defenders within the town should be divided into three groups, so that one group may be fighting, another resting, and the third preparing for action, and that there may always be on the wall soldiers who are fresh. And certain other picked troops, in considerable number, must go around the wall with the general, constantly relieving any section that is hard pressed. For the enemy fear the reserves more than the force already on duty before them. And the dogs should be tied up at this time, for when men are hurrying through the town, with noise of arms and confusion, if the dogs in addition, because

(κατὰ τὸ ἕτερον μέρος), but they are actually lifted only to an angle, say, of 45° to 60°, and their tips are then firmly fastened together. From the point of convergence timbers are extended to the sides and covers of the wagon-bodies and then a roof in the shape of an oblong pyramid is constructed. The passage is very obscure, however, and a corruption may lurk in the words συμπετασαντα κατά.

AENEAS TACTICUS

ἀθήθειαν¹ ὀρμῶσαι² αἱ κύνες ὀχλοῖεν ἂν προσ-
 κείμεναι.

4 Τοῖς τε ἐπὶ τῷ τείχει μαχομένοις παραινεῖν οἷα
 ἐκάστω δεῖ, τοὺς μὲν ἐπαινοῦντα,³ τῶν δὲ
 δεόμενον⁴ ὀργῇ δὲ μηδένα⁵ μετιέναι⁶ μηδὲ⁷ τῶν
 5 τυχόντων ἀνθρώπων· ἀθυμότεροι γὰρ εἶεν ἂν. εἰ δέ
 τινας δεῖ μετιέναι ἀμελοῦντας καὶ ἀκοσμοῦντας,
 τοὺς τὰ πλείστα κεκτημένους καὶ ἐν τῇ πόλει
 δυνάμεως⁸ μάλιστα μετέχοντας· εἶη γὰρ ἂν τι
 τοιοῦτο καὶ τοῖς ἄλλοις παράδειγμα. ἐν οἷς καιροῖς
 ἕκαστα τούτων δεῖ παρῆναι,⁹ ἐν τοῖς Ἀκουσμασι
 6 γέγραπται. χερμάδια δὲ μὴ ἐπιτρέπειν ἀκαίρως
 ἀφιέναι, παρεσκευάσθαι δὲ¹⁰ ὅπως καὶ τὰ ἀφεθέντα
 7 ἐν τῇ ἡμέρᾳ ἐν νυκτὶ ἀναλέγεται ὧδε. κατα-
 κρεμαννύειν χρῆ ἐν κοφίνοις ἄνδρας κατὰ τοῦ
 τείχεος οἷτινες ἀναλέξουσιν· τοὺς¹¹ δὲ ἄνδρας χρῆ
 τοὺς ἀναλέξαντας¹² τὰ χερμάδια ἀναβαίνειν εἰς τὸ
 τείχος, κατακρεμασθέντων δικτύων συείων ἢ ἐλα-
 φείων¹³ ἢ ταῖς ἐκ τῶν σχοινίων κλίμαξι πεποιη-
 8 μέναις. ταύτας δ' ἴσας¹⁴ εἶναι τὸν ἀριθμὸν τοῖς
 ἀναλέγουσιν ἀνθρώποις, ὅπως, εἴαν τινες πονῶσιν,
 ταχὺ ἀναβαίνωσιν· πύλας γὰρ μὴ ἀνοίγεσθαι νυκτός,
 ἀλλὰ ταῖς τοιαύταις κλίμαξι χρῆσθαι καὶ ἂν τινα
 βούλησθε.

¹ Casaubon: ἀλήθειαν M.

² Lange: ὀρῶσαι M.

³ Meineke: ἐπαινοῦντασ M.

⁴ Casaubon: τῶν δεδεμένων M.

⁵ μηθένα M.

⁶ Added by Casaubon.

⁷ Added by R. Schöne.

⁸ Orelli: δυναμένουσ M.

⁹ From παρήμι; for the sense compare 26. 8 (Pease):
 παραινεῖν Köchly and Rüstow; ποιεῖν Hercher: περαίνειν
 Oldfather.

of the unusual doings, should begin to run amuck, they would make trouble.

And to those who are fighting on the wall the general should give such advice as is necessary for each, to some commendation and to others an appeal, but he should not in anger reprimand anyone, even of the common soldiers, for that would dishearten them the more. If, however, it is necessary to reprimand anyone for neglect and lack of discipline, it should be those who are most wealthy and influential in the city, for such a case would be an example to the others also. The occasions on which it is expedient to overlook each of these matters I have discussed in the work on *Admonitions*. And one should not permit the throwing of small stones at unsuitable times, but should provide that even those thrown during the day may be gathered again during the night, in the following manner. Men should be let down from the wall in baskets to pick the stones up again, and when they have gathered them they should regain the wall by means of boar- or stag-nets which have been let down, or else by rope ladders, which should be equal in number to the men who are gathering the stones, so that if any are hard pressed they may quickly climb up again. For the gates must not be opened during the night, but ladders of this sort should be used, and other devices you may choose.

¹⁰ Casaubon: ὁ δὲ M.

¹¹ Hercher: θυρωσ M.

¹² Hertlein: ἀναλέγοντας M.

¹³ Orelli: δακτυλίων ἰστων πελαφίων M (with marks of corruption over the second ι and the ε).

¹⁴ Kirchhoff: δισσὰς M.

AENEAS TACTICUS

XXXIX. [Δολεύματα]

Χρῆ δὲ πολιορκουμένους καὶ τὰ τοιαῦτα τεχνάζειν. ἐν ταῖς πύλαις καὶ εἰς τὸ ἔσω μᾶλλον μέρος ὀρύξαντα τάφρον ἔνθεν καὶ ἔνθεν πάροδον λιπόντα, ἔπειτα ἐπεξελθόντας τινὰς ἀκροβολίζεσθαι καὶ προάγειν¹ τῶν πολεμίων ὥστε συνεισδραμεῖν² εἰς τὴν πόλιν. τοὺς μὲν οὖν ἐκ τῆς πόλεως καταφεύγοντας εἰς τὴν πόλιν χρῆ ἔνθεν καὶ ἔνθεν παρὰ τὰς λελειμμένας παρόδους εἰστρέχειν· τοὺς δὲ τῶν πολεμίων συνειστρέχοντας εἰκός³ ἐστὶ, μὴ προειδότας τὴν τάφρον, ἅμα τε καὶ κεκρυμμένης οὕσης, εἰσπίπτειν καὶ φθειρεσθαι ὑπὸ τῶν⁴ ἔσω τῆς πόλεως ἐν τῷ καιρῷ τούτῳ·⁵ τούτων δ' εἶναι συντεταγμένους τινὰς ἐν ταῖς διόδοις καὶ πρὸς⁶ τοῖς ὀρύγμασι τῶν⁷ πυλῶν χώραις. εἰάν δὲ πλείονες τῶν πολεμίων ἐπισφένονται καὶ βούλη⁸ αὐτοὺς κατέχειν,⁹ χρῆ ἠτοιμάσθαι ἄνωθεν¹⁰ ἀπὸ τοῦ μεσοπίλου πύλην ξύλων¹¹ ὡς παχυτάτων καὶ¹² σεσιδηρῶσθαι αὐτήν. ὅταν οὖν βούλη¹³ ἀπολαβεῖν¹⁴ τοὺς εἰστρέχοντας πολεμίους, ταύτην ἀφιέναι ὀρθήν· καὶ αὐτὴ τέ τινὰς ἢ πύλην φερομένην διαφθερεῖ¹⁵ καὶ τοὺς πολεμίους σχήσει μὴ εἰσιέναι, ἅμα δὲ καὶ τῶν ἐπὶ τῷ τείχει βαλλόντων τοὺς¹⁶ πρὸς ταῖς πύλαις πολεμίους. χρῆ δὲ τοῖς φίλοις ἀεὶ προειρηθῆσθαι, εἰάν ποτε αὐτοῖς¹⁷ πολέμιοι

¹ J. Afr.: προάγειν M.

² Casaubon: εἶη ὅσ M.

³ Added by R. Schöne: φθειρεσθαι ἔσω M.

⁴ Added by Hercher.

⁵ Casaubon: πρῶ M.

⁶ Added by Köchly and Rüstow.

⁷ Meier: βούλει M.

⁸ J. Afr.: ἔχειν M.

⁹ Casaubon: ἀνθεν M (with sign of corruption over a).

¹⁰ Orelli (after Casaubon): πύλην πυλῶν M.

XXXIX. [*Stratagems*]

Those undergoing siege should also contrive such measures as these. At the gates and somewhat inside them they should dig a trench and leave a passage on this side and on that. Then some of them should go out and engage in skirmishing and lure the enemy to make a dash into the town with them. Of course the men from the town, as they retire into it, are to run along the passages that have been left on either side, but it is likely that those of the enemy who run in with them, being unaware of the trench, especially since it is concealed, will fall into it and be killed at that instant by those within the city. And of these some should be stationed in the passages and in places at the trenches near the gate. And if a larger number of the enemy come in after these and you wish to catch them, you should have ready above the centre of the gate a portcullis of the stoutest possible timbers overlaid with iron.¹ When, then, you wish to cut off the enemy as they rush in, you should let this drop down, and the portcullis itself will not only as it falls destroy some of them, but will also keep the foe from entering, while at the same time the forces on the wall are shooting the enemy at the gate. And you should always give instructions in advance to your own party, in case the enemy rush

¹ Vegetius iv. 4 speaks of this device as one *quod invenit antiquitas*. It was employed successfully by the men of Salapia in 208 B.C. against Hannibal (Livy xxvii. 28. 10-12), and by the Lycians of Xanthus against M. Junius Brutus in 42 B.C. (Appian, *Bell. Civ.* iv. 78).

¹¹ Hertlein: ὑπολαβεῖν M.

¹² Orelli: πολιφερομένη διαφέρει M.

¹³ Hertlein: ἀνθισ M.

AENEAS TACTICUS

συνεισπίπτωσιν, ὅπη τῆς πόλεως συναθροισθή-
 σονται, ὅπως τῷ τόπῳ οἱ φίλοι διαγιγνώσκονται·
 οὐ γὰρ ῥάδιον μιγάδας τε ὄντας μεθ' ὄπλων καὶ
 μετὰ θορύβων συνεισπίπτοντας διαγιγνώσκεσθαι.
 6 ἤδη δὲ τοῖς θρασυνομένοις τε λίαν¹ καὶ προσ-
 πελάζουσι τῷ τείχει ἐγγυτέρω τοῦ προσήκοντος
 νυκτὸς ἢ μεθ' ἡμέραν, βρόχους ἡμέρας μὲν κρυφαίως
 κατεσκεύασαν νυκτὸς δὲ ἀκρύπτους, οἷς προ-
 καλούμενοι² ἀκροβολισμοῖς τὸν εἰσπεσόντα ἀνα-
 7 σπάσουσιν. ἔστω δὲ ὁ μὲν βρόχος ὄπλου ὡς
 ἰσχυροτάτου, τὸ δὲ ἔλκον ἐπὶ δύο πήχεις ἄλυσις,³
 τοῦ μὴ διατμηθῆναι· τὸ δ' ἄλλο, ὅθεν ἔλκουσι,
 σχοίνου. ὄλος⁴ δὲ ἔσω κατακρέμαται καὶ ἀνα-
 σπᾶται ὄπλοις ἢ κηλωνείοις.⁵ οἱ δὲ πολέμοι
 ἐὰν διατέμνειν ἐπιχειρῶσι, πρὸς ταῦτα πάλιν οἱ
 ἔσωθεν κηλωνείοις χρῶνται καθιέντες, ἵνα μὴ δια-
 τέμνηται· αἱ γὰρ ἀλύσεις πρὸς τὰ τοιαῦτα πραγ-
 ματῶδες καὶ δυσμεταχειρίστον, ἅμα δὲ καὶ
 ἀλυσιτελές.⁶

XL. [Φυλακὴ πόλεως]

Ἄν ἢ ἡ πόλις μεγάλη καὶ μὴ ἱκανοὶ ὦσιν οἱ ἐν
 τῇ πόλει ἄνθρωποι περίστασθαι ἐν κύκλῳ τῇ
 πόλιν, τοῖς δὲ ὑπάρχουσι θέλῃς αὐτὴν διαφυλάξαι,
 χρὴ τῆς πόλεως ὅσα ἂν ἢ εὐπρόσοδα οἰκοδομῆν
 ὑψη⁷ ἐκ τῶν ὑπαρχόντων, ἵνα, ἂν τινες τῶν
 πολεμίων ἢ λαθραίως ἢ βία ἀναβῶσιν, ἐν ἀπειρίᾳ⁸

¹ Hercher: τέλειον M.

² Köchly and Rüstow: προσκαλούμενοι M.

³ Casaubon: ἀλυσεισ M, ἀλυσισ C.

⁴ Köchly and Rüstow: ὄλος M.

⁵ Casaubon: αλωνίσισ M. ⁶ Casaubon: λυσιτελέσ M.

⁷ Meineke (or ὑψη): ὑψει M: ὑψηλὰ J. Afr.

ÆNEAS THE TACTICIAN, xxxix. 5 - xl. 1

in with them, in what place in the city they are to make their rendezvous, in order that your friends may be distinguished by their position. For it is not easy to distinguish between men in a promiscuous armed throng, rushing confusedly in together. And on some occasions, against enemies who were over-confident and were approaching the wall more closely than was prudent, either by night or by day, the defenders have made ready nets, secretly by day, but by night without attempt at concealment, and luring the enemy forward by skirmishes have hauled up those who became entangled. The net should be of the very strongest rope, and the line that lifts it should be of chain for a distance of two cubits, to prevent its being severed, but the rest, from the point where they are pulling it, may be of rope. The whole device is let down and hauled up from within the wall by ropes or by swing-beams. If, however, the enemy try to cut their way out, then to meet this the besieged should again use swing-beams, letting them down so that the net may not be cut; for to use chains to prevent such an occurrence is troublesome and inconvenient, as well as too costly.

XL. [*Guarding a City*]

If the city is a large one and the men in the city are not numerous enough to man its walls all the way around, and yet you wish to keep it closely guarded with the men you have, you should, from the materials at hand, build up high all the easily assailable parts of the city wall, so that if any of the enemy shall scale them, either by stealth or by

⁸ ἀπορία Casaubon, Hercher. Capps.

AENEAS TACTICUS

- γενόμενοι μὴ δύνωνται καταπηδᾶν ἀφ' ὑψηλῶν, ἅμα παντάπασι¹ μὴ ἔχοντες ὄπη καταβαίνωσιν. παρὰ δὲ τὰ ὠκοδομημένα ἔνθεν καὶ ἔνθεν φυλασσόντων ἐκ τῶν² ὑπαρχόντων ἀνθρώπων, ἵνα τοὺς καταπηδῶντας ἀπὸ τῶν ὑψηλῶν διαφθείρωσιν.
- 2 Διονύσιος δὲ πόλιν ὑποχείριον ποιησάμενος, ἀνδρῶν τῶν μὲν³ ἐν τῇ πόλει τεθηκότων, τῶν δὲ πεφευγόντων, ἠθέλησε κατασχεῖν· ἦν δὲ μείζων ἢ
- 3 ὥστε ὑπ' ὀλίγων φυλάσσεσθαι. ἐπιμελητὰς μὲν οὖν τιὰς μετ' ὀλίγων οὐς ἐνεδέχето ἐπέστησε,⁴ τῶν δὲ ἐν τῇ πόλει τὰ μέγιστα δυναμένων τοῖς οἰκέταις⁵ συνώκισεν τῶν δεσποτῶν τὰς θυγατέρας καὶ γυναῖκας καὶ ἀδελφάς· οὕτω γὰρ οὖν⁶ ὤτεο μάλιστα πολεμιωτάτους ἔσεσθαι τοῖς δεσπόταις
- 4 καὶ αὐτῶ⁷ πιστοτέρους. Σινωπεῖς δὲ πρὸς Δαταμᾶν πολεμοῦντες ἐπεὶ ἐν κινδύνῳ ἦσαν καὶ σπάνει ἀνδρῶν, τῶν γυναικῶν τὰ ἐπιεικέστατα σώματα μορφώσαντες καὶ ὀπλίσαντες ὡς ἐς ἄνδρας μάλιστα, ἀντὶ ὄπλων καὶ περικεφαλαίων τοὺς τε κάδους καὶ τὰ ὁμότροπα τούτοις δόντες χαλκώματα, περιῆγον τοῦ τείχους ἢ μάλιστα οἱ πολέμοιο ὄψεσθαι
- 5 ἔμελλον. βάλλειν δέ⁴ οὐκ εἶων αὐτάς· πόρρωθεν γὰρ κατάδηλος βάλλουσα γυνή. ποιούντες δὲ ταῦτα τοὺς αὐτομόλους ἐφύλασσον μὴ διαγγεληθῆ.
- 6 Ἐὰν δὲ θέλης ἐπὶ τῷ τείχει περιόδους πλείους

¹ Oldfather (or ἄλλη): ἀλλὰ πασιπασι M (with mark of corruption over the third and the fourth α): πάλιν ἀπίωσι Orelli: ἀλλ' ἀπορώσι τοῖς πᾶσι Casaubon.

² ἐκ τῶν added by Casaubon: οἱ ὑπάρχοντες ἄνθρωποι J. Afr.

³ Added by Lincke (*Philol.*, 1914, 157).

⁴ Added by Casaubon.

⁵ Köchly and Rüstow: δυναμένους οἰέτας M.

⁶ Meineke: ἄν M.

⁷ Sauppe: αὐτῶ M.

AENEAS THE TACTICIAN, XL. 1 - 6

force, from their unfamiliarity they may not be able to leap down from great heights, being at the same time completely at a loss for any place to descend. And at either side of the parts that have been built up some of the available men should keep watch to destroy those who may leap from the high points.

When Dionysius¹ had subjugated a certain city and some of its defenders had been killed and the others had fled, he wished to retain the place, but it was too large to be guarded by a small force. Accordingly he left some in charge with a few available men, and to the slaves of the most influential men in the city he married the daughters, wives, and sisters of their masters; for in this relation he thought that the slaves would be most hostile to their masters and more faithful to him. Again, the people of Sinope in their war against Datamas,² when they were in danger and in need of men, disguised the most able-bodied of their women and armed them as much like men as they could, giving them in place of shields and helmets their jars and similar bronze utensils, and marched them around the wall where the enemy were most likely to see them. But they did not allow them to throw missiles, for even a long way off a woman betrays her sex when she tries to throw. While they were doing this they took care that deserters should not disclose the stratagem.

If you wish the patrolmen upon the wall to appear

¹ Clearly Dionysius I. of Syracuse, but the precise occasion is unknown.

² His active career extended from *circa* 384 to 362 B.C. Köchly in a note sets this event in 379-8, but the reasoning is not very cogent.

AENEAS TACTICUS

φαίνεσθαι, χρή περιμέναί ἐπὶ δύο, ἔχοντας τὰ δόρατα τὸν ἕνα στίχον ἐπὶ τῷ ἀριστερῷ ὤμῳ, τὸν δ' ἕτερον ἐπὶ τῷ δεξιῷ· καὶ οὕτω φανοῦνται εἰς 7 τέσσαρας. εἰάν δὲ κατὰ¹ τρία περιώσι,² τὸν μὲν πρῶτον ἄνδρα ἐπὶ τῷ δεξιῷ ὤμῳ ἔχειν τὸ δόρυ, τὸν δ' ἕτερον ἐπὶ τῷ ἀριστερῷ· καὶ οἱ ἄλλοι κατὰ ταῦτά. καὶ οὕτω φανοῦνται εἰς δύο.³

8 Περὶ δὲ τροφῆς ἀσίτου καὶ ὧν σπάνις ἐν πολιορκίᾳ καὶ ὑδάτων ὡς δεῖ πότιμα ποιεῖν, ἐν τῇ Παρασκευαστικῇ βύβλῳ δεδήλωται. ἐπεὶ δὲ ταῦθ' ἡμῖν εἴρηται, περὶ ναυτικῆς τάξεως δίδειμι.

Ναυτικοῦ δὲ στρατεύματος δύο εἰσὶ στόλοι. . . .⁴

¹ Added by R. Schöne.

² C: περιώσι M.

³ The manœuvre described by Aeneas does not produce the result desired. Possibly the text is corrupt; if so, the corruption is very old, as J. Afr. has essentially the same provisions. R. Schöne (elaborating a suggestion of Graux) suggests: εἰάν δὲ ἐθέλῃς ἐπὶ τῷ τείχει περιόδους δύο πλείους φαίνεσθαι, χρή περιμέναί ἐπὶ δύο, ἔχοντας ἀνὰ δύο δόρατα (οἱ δύο ἔχοντας ἕκαστον δόρατα), τὸ ἕν ἐπὶ τῷ ἀριστερῷ ὤμῳ, τὸ δ' ἕτερον ἐπὶ τῷ δεξιῷ· καὶ οὕτω φανοῦνται εἰς τέσσαρας. εἰάν δὲ κατὰ τρία (sc. σώματα) περιώσι, τὸν μὲν πρῶτον ἄνδρα ἐπὶ τῷ δεξιῷ ὤμῳ ἔχειν τὸ ἕν δόρυ, τὸ δ' ἕτερον ἐπὶ τῷ ἀριστερῷ· καὶ οἱ ἄλλοι (sc. ἐχέτωσαν) κατὰ ταῦτά· καὶ οὕτω φανοῦνται εἰς ἕκαστος δύο. "If you wish two patrolmen upon the wall to appear more numerous than they are, you should make them go their rounds two abreast, each man with two spears, one on

AENEAS THE TACTICIAN, XL. 6 - 8

more numerous than they are,¹ you should make them go their rounds two abreast, one rank with their spears upon the left shoulder, the other with their spears upon the right, and thus they will appear to be four abreast. And if they go about three abreast, the first man should have his spear upon his right shoulder, the next upon his left, and the others similarly, and in this way each man will look like two.

Now about wheatless rations and things of which there is a scarcity during a siege, and about how waters are to be rendered drinkable, I have explained in the book on *Military Preparations*. And inasmuch as these points have been described I shall pass on to naval manœuvres.

Of a naval armanent there are two forms of equipment. . . .

¹ See the critical note for a discussion of this passage.

his left shoulder, and the other on his right, and thus they will appear to be four abreast. And if they go about three abreast, the first man should have one spear on his right shoulder, and the other on his left, and the others similarly, and in this way each separate man will look like two."

⁴ The subscription in M runs *Αἰνείου πολιορκητικά· ἡ Αἰλιανοῦ καθὼς ἡ ἀρχή* followed by an erasure of 13 letters. See the Introduction, p. 2.

TESTIMONIA ET FRAGMENTA

I.

Aelian, *Tact.* i. 2 καὶ περὶ τῆς καθ' Ὁμηρον τακτικῆς ἐνετύχομεν συγγραφεῦσι Στρατοκλεῖ καὶ Ἑρμείᾳ καὶ Φρόντωνι τῷ καθ' ἡμᾶς ἀνδρὶ ὑπατικῷ. ἐξειργάσαντο δὲ τὴν θεωρίαν Αἰνεΐας τε διὰ πλειόνων ὁ καὶ στρατηγικὰ βιβλία ἱκανὰ συνταξάμενος, ὧν ἐπιτομὴν ὁ Θετταλὸς Κινέας ἐποίησε, Πύρρος τε ὁ Ἑπειρώτης τακτικὰ συνέταξε καὶ Ἀλέξανδρος ὁ τούτου υἱὸς καὶ Κλέαρχος.

II.

Aelian, *Tact.* iii. 4 ὄρον δὲ αὐτῆς (sc. τῆς τακτικῆς) ἔθεντο Αἰνεΐας μὲν ἐπιστήμην εἶναι πολεμικῶν κινήσεων, Πολύβιος δέ, εἰάν τις πλήθος ἄτακτον παραλαβὼν τοῦτο συγκρίνη καὶ καταλοχίσας συλλοχίσῃ παιδεύσῃ τε χρησίμως τὰ πρὸς τὸν πόλεμον.

III.

Polybius x. 44 Αἰνεΐας δὲ βουλευθεῖς διορθώσασθαι τὴν τοιαύτην ἀπορίαν, ὁ τὰ περὶ τῶν στρατηγικῶν ὑπομνήματα συντεταγμένος, βραχὺ μὲν τι προεβίβασε, τοῦ γε μὴν δέοντος ἀκμὴν πάμπολυ τὸ κατὰ τὴν ἐπίνοιαν ἀπελείφθη. γνοίη δ' ἂν τις ἐκ τούτων. φησὶ γὰρ δεῖν τοὺς μέλλοντας

200

ATTESTATIONS AND FRAGMENTS

I.

And upon the subject of tactics in Homer we have read Stratocles and Hermeas and Fronto the ex-consul of our own time. Now the theory has been elaborated both by Aeneas in detail (and he also composed a considerable number of military manuals, of which Cineas the Thessalian made an epitome), and by Pyrrhus of Epirus, who composed a treatise on tactics, and by Alexander his son, and by Clearchus.

II.

Aeneas defined it (*sc.* tactics) as the science of military movements, but the definition of Polybius was, that tactics was when a man took an unorganized crowd, arranged it, divided it into companies, grouped them together, and gave them a practical military training.

III.

Aeneas, therefore, the writer of the treatise on tactics, wished to correct this defect, and did in fact make some improvement; but his invention still fell very far short of what was wanted, as the following passage from his treatise will show. "Let

¹ Reiske: τὸ ἄλλο.

AENEAS TACTICUS

ἀλλήλοις διὰ τῶν πυρσῶν δηλοῦν τὸ κατεπεῖγον ἀγγεῖα κατασκευάσαι κεραμεᾶ¹ κατὰ τε τὸ πλάτος καὶ κατὰ τὸ βάθος ἰσομεγέθη πρὸς ἀκρίβειαν· εἶναι δὲ μάλιστα τὸ μὲν βάθος τριῶν πήχων, τὸ δὲ πλάτος πήχεος. εἶτα παρασκευάσαι φελλοὺς βραχὺ κατὰ πλάτος ἐνδεεῖς τῶν στομάτων, ἐν δὲ τούτοις μέσοις ἐμπεπηγέναι βακτηρίας διηρημένας² ἴσα μέρη τριδάκτυλα, καθ' ἕκαστον δὲ μέρος εἶναι περιγραφὴν εὔσημον. ἐν ἑκάστῳ δὲ μέρει γεγράφθαι τὰ προφανέστατα καὶ καθολικώτατα τῶν ἐν τοῖς πολεμικοῖς συμβαινόντων, οἷον εὐθέως ἐν τῷ πρώτῳ διότι πάρεσιν ἰππεῖς εἰς τὴν χώραν, ἐν δὲ τῷ δευτέρῳ διότι πεζοὶ βαρεῖς, ἐν δὲ τῷ τρίτῳ ψιλοί, τούτων δ' ἐξῆς πεζοὶ μεθ' ἰππέων, εἶτα πλοῖα, μετὰ δὲ ταῦτα σίτος, καὶ³ κατὰ τὸ συνεχὲς οὕτω, μέχρις⁴ ἂν ἐν πάσαις γραφῇ ταῖς χώραις τὰ μάλιστ' ἂν ἐκ τῶν εὐλόγων προνοίας τυγχάνοντα καὶ συμβαίνοντα κατὰ τοὺς ἐνεστώτας καιροὺς ἐκ τῶν πολεμικῶν. τούτων δὲ γενομένων ἀμφότερα κελεύει τρῆσαι⁵ τὰ ἀγγεῖα πρὸς ἀκρίβειαν, ὥστε τοὺς αὐλίσκους ἴσους εἶναι καὶ κατ' ἴσον ἀπορρεῖν· εἶτα πληρώσαντας ὕδατος ἐπιθεῖναι τοὺς φελλοὺς ἔχοντας τὰς⁶ βακτηρίας, κάπειτα τοὺς αὐλίσκους ἀφεῖναι ρεῖν ἅμα. τούτου δὲ συμβαινόντος δῆλον ὡς ἀνάγκη, πάντων ἴσων καὶ ὁμοίων ὄντων, καθ' ὅσον ἂν ἀπορρέῃ τὸ ὑγρὸν, κατὰ τοσοῦτον τοὺς φελλοὺς καταβαίνειν καὶ τὰς βακτηρίας κρύπτεσθαι κατὰ τῶν ἀγγείων. ὅταν δὲ τὰ προειρημένα γένηται κατὰ τὸν χειρισμὸν ἰσοταχῆ καὶ σύμφωνα, τότε κομίσαντας ἐπὶ τοὺς

¹ Dindorf: κεραμμοῖα or κεραμαῖα mss.

² These two words added by Casaubon.

FRAGMENTS

those who wish," he says, "to communicate any matter of pressing importance to each other by fire-signals prepare two earthenware vessels of exactly equal size both as to diameter and depth. Let the depth be three cubits, the diameter one. Then prepare corks of a little shorter diameter than that of the mouths of the vessels : and in the middle of these corks fix rods divided into equal portions of three fingers' breadth, and let each of these portions be marked with a clearly distinguishable line ; and in each let there be written one of the most obvious and universal of those events which occur in war ; for instance in the first 'cavalry have entered the country,' in the second 'hoplites,' in the third 'light-armed,' in the next 'infantry and cavalry,' in another 'ships,' in another 'corn,' and so on, until all the portions have had written on them the measures on the part of the enemy which may reasonably be foreseen and are most likely to occur in the present emergency. Then carefully pierce both the vessels in such a way that the taps shall be exactly equal and carry off the same amount of water. Fill the vessels with water and lay the corks with their rods upon its surface and set both taps running together. This being done, it is evident that, if there is perfect equality in every respect between them, both corks will sink exactly in proportion as the water runs away, and both rods will disappear to the same extent into the vessels. When they have been tested and the rate of the discharge of the water has been found to be exactly equal in both, then the vessels should be taken

³ Added by Casaubon.

⁵ Scaliger : *τηρήσαι* MSS.

⁴ Casaubon : *μέχρι* MSS.

⁶ Added by Reiske.

AEENEAS TACTICUS

τόπους ἐν οἷς ἑκάτεροι μέλλουσιν συντηρεῖν τὰς πυρσείας, ἑκάτερον θεῖναι τῶν ἀγγείων. εἴτ' ἐπὶ ἐμπέση τι τῶν ἐν τῇ βακτηρίᾳ γεγραμμένων, πυρσὸν ἄραι κελεύει, καὶ μένειν ἕως ἂν ἀνταίρωσιν οἱ συντεταγμένοι· γενομένων δὲ φανερῶν ἀμφοτέρων ἅμα τῶν πυρσῶν καθελεῖν, εἴτ' εὐθέως ἀφεῖναι τοὺς αὐλίσκους ρεῖν. ὅταν δὲ καταβαίνοντος τοῦ φελλοῦ καὶ τῆς βακτηρίας ἔλθῃ τῶν γεγραμμένων ὁ βούλει δηλοῦν κατὰ τὸ χεῖλος τοῦ τεύχους, ἄραι κελεύει τὸν πυρσόν· τοὺς δ' ἑτέρους ἐπιλαβεῖν εὐθέως τὸν αὐλίσκον, καὶ σκοπεῖν τί κατὰ τὸ χεῖλος ἐστὶ τῶν ἐν τῇ βακτηρίᾳ γεγραμμένων· ἔσται δὲ τοῦτο τὸ δηλούμενον, πάντων ἰσοταχῶς παρ' ἀμφοτέροις κινουμένων.

Suidas Αἰνείας· οὗτος ἔγραψε περὶ πυρσῶν, ὡς φησι Πολύβιος, καὶ περὶ στρατηγημάτων ὑπόμνημα.

IV.

Jul. Africanus, Κεστοί c. 37 p. 302^a Thev. (according to mss. EP¹) φασὶ δὲ τινες τῶν ἀρχαίων ὅτι καὶ <ὁ> τοῦ ἐχέως ἰὸς καὶ ἀσπίδος σαλαμάνδρης τε εἰς τοῦτο (sc. χρῖσμα βελῶν) ἀπαράβατος.

V.

Johannes Lydus, Περὶ ἀρχῶν τῆς Ῥωμαίων πολιτείας i. 47, in defining ἀδωράτορες and βετερανοί, cites a series of Roman authorities and then: Ἑλλήνων δὲ Αἰλιανὸς καὶ Ἀρριανὸς, Αἰνείας,

¹ Shuckburgh's translation, slightly revised.

² This notice is clearly taken direct from Polybius.

³ The same substances are mentioned in Philo Mechanicus

FRAGMENTS

respectively to the two places from which the two parties intend to watch for fire-signals. As soon as any one of these eventualities which are inscribed upon the rods takes place, Aeneas bids raise a lighted torch, and wait until the signal is answered by a torch from the others ; then, when both torches have been simultaneously visible, lower them, and then immediately set the taps running. When the cork and rod on the signalling side has sunk low enough to bring the ring containing the words which give the desired information on a level with the rim of the vessel, a torch is to be raised again. Those on the receiving side are then at once to stop the tap, and to see which of the messages written on the rod is on a level with the rim of their vessel. This will be the same as that on the signalling side, assuming everything to be done at the same speed on both sides.”¹

Aeneas wrote on signal-fires, as Polybius said, and a treatise on stratagems.²

IV.

Some of the ancients say that the poison of the viper, asp, and salamander does not lose its virtue for this purpose (*i.e.* the smearing of missiles).³

V.

And of the Greeks, Aelian and Arrian, Aeneas,

v. 90. 17 ff. as necessary supplies in a beleaguered city. Such topics as this must have been treated by Aeneas in his *Παρασκευαστική βιβλος*, *On Military Preparations*. See 8. 2-5; 40. 8, and the Introduction, p. 8.

AENEAS TACTICUS

Ὀνήσανδρος, Πάτρων, Ἀπολλόδωρος ἐν τοῖς πολιορκητικοῖς, κτλ.¹

JULII AFRICANI Κεστῶν CAPITA EX AENEAE EXCERPTA²

XXXVIII. Πῶς πῦρ δυνάμεθα σβέσαι (= Ch. 34)

Ἐὰν ἡμῶν οἱ πολέμιοι πυρὶ κατασκευαστῶ τεῖχος ἢ τι ἕτερον ἐμπρήσουσι, πῶς σβέσαι δυνάμεθα; σβέσομεν αὐτὸ συντόμως καταχέοντες ὄξος. τοὺς δὲ σβεννύντας ἀπὸ τῶν ὑψηλοτέρων δεῖ περὶ τὸ πρόσωπον ἔχειν ἔρυμα τι³ ἵνα ἦσσαν ὀχλοῦνται προσαΐσσοῦσης αὐτοῖς τῆς φλογός. εἰ δὲ σὺ προγνώσῃς τὰ μέλλοντα καίεσθαι, χρίσον ἔξωθεν ὄξος, καὶ τούτοις οὐ πρόεισι πῦρ.

XLV. Πῶς ἡμεῖς ἐμπρήσωμεν; (= Ch. 33. 1)

Ἐμπρήσωμεν ἡμεῖς καθ' ἡμῶν ἐρχόμενον μάγανον ἢ ναῦν⁴ ἢ πύργον πολέμιον οὕτως· ἐπιχεῖν⁵ δεῖ πίσσαν καὶ θεῖον ἐπιβάλλειν, ἔπειτα φλογώσαντα φάκελλον ἐπαφεῖναι⁶ σχοινίῳ ἐφ' ὅπερ θέλομεν. τὰ δὲ τοιαῦτα προτεινόμενα⁷ ἀφ' ὧν ἰστάμεθα τόπων ἐπιβάλλεται τοῖς ἐπιφερομένοις.

XLVI. Πρὸς καιομένας πύλας (= Ch. 33. 4)

Ἐὰν ἐμπρησθῶσιν αἱ πύλαι, δεῖ προσφέρεσθαι ξύλον καὶ ἐμβάλλοντα⁸ ὡς μέγιστον τὸ πῦρ ποιεῖν,

¹ This testimony is not given by R. Schöne. The citation of Aeneas involves an obvious anachronism.

² For these excerpts we give R. Schöne's constitution of the text, noting only those points at which some change seems necessary.

⁴ Boivin: ἵνα οὖν MSS.

³ Meursius: ἐρύματι MSS.

⁵ Boivin: ἐπισχέειν MSS.

FRAGMENTS

Onesander, Patro, and Apollodorus, in their works on the besieging of cities.

EXCERPTS FROM AENEAS IN THE *Κεστοί* OF JULIUS AFRICANUS

XXXVIII. *How we can put out Fire*

If our enemies shall set on fire a palisade or anything else with an incendiary preparation, how can we put out the fire? By pouring vinegar over it we shall at once put it out. Those who put out the fire from places above it must have some protection for the face, that they may be less annoyed when the flame darts toward them. And if you know in advance the parts that are likely to be set on fire, rub vinegar¹ on the outside, and the flame will not advance on them.

XLV. *How shall we ourselves set Things on Fire?*

Let us set on fire an engine coming against us or a ship or a hostile tower in this manner. One must pour pitch and cast sulphur, then set on fire a fagot and let it down by a rope upon the particular object we wish. And such things as these, held out from the places in which we are standing, are hurled at the approaching engines.

XLVI. *Against the Burning of a Gate*

If the gate is set on fire you must bring up wood and throw it on to make as large a fire as possible,

¹ See note on Aeneas, ch. 34. 1.

⁶ Cod. Monac. 195 m². ⁷ Boivin: *προτεινομένων* MSS.

⁸ Aeneas: *ἐμβάλλονται οὐ ἐμβάλλοντας* MSS.

AENEAS TACTICUS

μέχρις οὐ ταφρεύσει τὰ ἔσωθεν, καὶ ἐάν τι δέη¹
ἐκ τῶν σοι ὑπαρχόντων οἴκοι καθαίρειν.²

XLVIII. Περὶ κλεψύδρας (= Ch. 22. 24 f.)

Κλεψύδρα πάνυ χρήσιμον³ κτῆμα πρὸς τοὺς
νύκτωρ φυλάσσοντας, μακροτέρων ἢ βραχυτέρων
νυκτῶν γινομένων· αὕτη δὲ συμβάλλεται οὕτως.
χρῆ κεκηρῶσθαι αὐτῆς τὰ ἔσωθεν καὶ μακροτέρων
γινομένων τῶν νυκτῶν ἀφαιρῆσθαι τοῦ κηροῦ,
ἵνα πλέον ὕδωρ χωρῆ, βραχυτέρων δὲ προσ-
πλάσσεσθαι, ἵνα ἔλασσον δέχηται. τὴν δὲ ταύτης
ὀπήν ἀκριβῶς δεῖ ποιῆσθαι,⁴ δι' ἧς τὸ τῆς προ-
θεσμίας ὕδωρ ἐκρεῖ.

XLIX. Πυλωρικόν (= Ch. 28. 1-4; 29. 12)

Ἐν φόβῳ μενούσης⁵ πόλεως τάδε δεῖ προ-
νοεῖσθαι. πύλας τὰς μὲν ἄλλας κεκλείσθαι, μίαν
δὲ ἀνεῶχθαι, δι' ἧς ἂν δυσπροσοδῶτατον ἢ⁶ τῆς
πόλεως καὶ ἐπὶ πλείστον ἀπ' αὐτῶν μέλλουσιν
ὄρασθαι οἱ προϊόντες. καὶ ἐν αὐτῇ τῇ πύλῃ δεῖ
ἐκτομάδα,⁷ ἵνα σώματα μὲν ἀνθρώπων δι' αὐτῆς
εἰσῆ⁸ ἐν καθ' ἑν. οὕτως γὰρ ἂν ἦκιστα τις
λανθάνῃ⁹ καὶ δι' αὐτῆς εἰσιῶν αὐτόμολος¹⁰ ἢ
κατάσκοπος, ἐάνπερ ὁ πυλωρὸς ἢ νοηρός. πᾶν
δὲ ἀνοίγεσθαι¹¹ ὑποζυγίων ἕνεκεν καὶ ἀμαξῶν καὶ
ἄλλων ἀγωγίμων ἀποτρέπω. εἰ δέ τι τούτων

¹ Aeneas: δὲ ἐνὶ MSS.

² Paris. 2441.

³ After this word the MSS. have τὸ.

⁴ Boivin: πνεῖσθαι MSS.

⁵ μὲν οὔσης Boivin.

⁶ δυσπροσοδῶτατον ἢ later MSS.; others δυσπροσοδῶτατον ἢ.

⁷ Boivin adds εἶναι.

⁸ Aeneas: εἰσὶν MSS.

FRAGMENTS

even if it be necessary to tear down some one of the buildings that stand in your town, until you can dig your trench inside.

XLVIII. *On the Water-Clock*

A water-clock is a very useful thing for those who are keeping guard at night, according as the nights become longer or shorter, and it is constructed as follows. One should smear the interior of the clock with wax, and then remove some of the wax when the nights grow longer, so that the clock may contain more water. When, on the other hand, the nights grow shorter, more wax should be added in order that the clock's capacity may be less. And its orifice, through which the water for a particular period flows out, must be made with exactness.

XLIX. *On Gates*

When a city is in constant fear precautions must be taken as follows. Close the other gates but leave one open, where access to the city is most difficult, and where those who advance are going to be in plain sight for the longest distance. And in this gate there should be a wicket-gate, so that men may pass through it singly. For in this way anyone, whether deserter or spy, is least able to escape notice if he should enter, if the gate-keeper is sharp-witted. Yet I advise against opening the whole gate for beasts of burden, wagons, and other things that are brought in. But if it shall be necessary to bring

⁹ Boivin: *λανθάνει* MSS.

¹⁰ Boivin: *ἀπτόμολις* MSS.

¹¹ Aeneas: *ἀνύεσθαι* MSS.

AENEAS TACTICUS

αναγκαίως δεήσει δι' ἀμαξῶν εἰσκομίζεσθαι, σίτου ἢ οἴνου ἢ ἐλαίου ἢ τῶν τοιούτων τι, σωματῶν πλήθει ταῦτα εἰσκομίζεσθαι δεῖ προεξιόντος στρατεύματος. τὸ δὲ ὅλον πρᾶγμα πύλας πρῶτ' μὴ ἀνοίγεσθαι, ὀψίτερόν τε μηθένα ἔξω ἀφίεσθαι, πρὶν ἂν ἐξερευνήσῃ τὰ περὶ τὴν πόλιν. ἔτι τε μήτε πλοῖα κατ' αὐτὰς ὀρμίζεσθαι, ἀλλὰ ἀποτέρω¹ (29. 12) χρῆ γὰρ καὶ τοὺς ἐλλιμενιστὰς² προσορμιζομένων πλοίων νυκτὸς ἢ ἡμέρας περὶ τούτων μὴ³ ἀδιασκέπτως ἔχειν, ἀλλ' ἐμβαίνοντας⁴ ἰδεῖν αὐτοὺς τὰ ἀγώγιμα, ἐνθυμουμένους ὅτι τούτων καταμελήσαντες τὰ μεγάλα ἐσφάλησαν.

L. Ὀπλων λάθρα εἰσκομιδὴ (= Ch. 29. 1-12)

Περὶ τῆς τῶν ὀπλων λάθρα εἰσκομιδῆς ἣτις ἐστὶν αὕτη ἐκτέθεται⁵ τοῖς μὲν παλαιοῖς πολλάκις πεπραγμένη, ἡμῖν δὲ παράδειγμα γινομένη πρὸς τὸ πράττειν ἢ⁶ θέλομεν, καὶ μὴ πάσχειν ὡς εἰδότες. εἴ⁷ μὲν οὖν ἐστὶν ἑορτὴ πάνδημος τοῖς ἀφ' ἡμῶν ἐκεῖσε προενδημοῦσι ξένοις καὶ προδόταις ὡς εἰς τὸ μέλλον ἡμῖν συμπράττουσιν, εἰσκομίζεσθαι δεῖ θώρακας λινέους καὶ στολίδας καὶ περικεφαλαίας ὄπλα κνημίδας μαχαίρας τόξα⁸ τοξεύματα ἐν κιβωτίοις ὡς φορταγωγοῖς κατεσκευασμένα, ὡς ἱματίων⁹ ἐνότων καὶ ἄλλων ἀγωγίμων. ἅπερ οἱ ἐλλιμενισταὶ¹⁰ ἀνοίξαντες

¹ Aeneas: ἀποτέρων mss.

² Meursius and Cod. Paris. 2437. ³ Cod. Paris. 2437.

⁴ Boivin: ἐμβαίνοντα mss. ⁵ Boivin: ἐκτέθεται mss.

⁶ Boivin: ἢ mss. ⁷ Later mss.: ἢ older mss.

⁸ Aeneas: τοξότοξεύματα mss.

⁹ Aeneas: ἱμάτιον mss. ¹⁰ Aeneas: ἐνλιμενισταὶ mss.

FRAGMENTS

in any of these things in wagons—some grain, or wine, or oil, or such supplies—you should send the army out beforehand, and bring the goods in with a gang of men. In general, the gates must not be opened early in the day, and even later no one should be let out until the region around the city has been reconnoitred. Again, boats are not to be moored at the gates but at a distance. For the revenue officers also must be watchful of vessels which anchor near by, night or day, and they must go on board and personally see the wares, having in mind that men who have neglected these precautions have suffered serious disasters.

I. *Importation of Arms by Stealth*

Concerning the stealthy importation of arms, as to just what it is, this has often been set forth by the old writers, and has become to us a model for accomplishing what we desire, and, through this knowledge, for avoiding mishap. So, if there is a public holiday, there must be brought in for the aliens¹ on our side who have previously established themselves there, and traitors co-operating with us in what is to take place, linen corslets and cloaks and helmets, shields, greaves, short swords, bows, arrows, stowed away in chests like those of merchants, just as if clothing and other merchandise were in them. The revenue officers opening these

¹ These may have been mercenaries hired by 'us,' *i.e.*, by the exiled faction which is seeking to regain possession of the city. The original in *Aeneas* is written from the point of view of the defenders of the town.

AENEAS TACTICUS

καὶ ἰδόντες, ὡς ἱμάτια μόνον τιμῆσονται. εἴτ' αὐτὰ¹ εἰσάγεσθαι καὶ τιθέναι πρὸ τῆς ἀγορᾶς· ἐν δὲ ταρσοῖς καὶ ρίποις² καὶ ἰστίοις³ ἡμιυφαντιαίοις δοράτια καὶ ἀκόντια ἐνειλημένα, ἐν δὲ ἄγγεσιν⁴ ἀχύρων πέλται καὶ μικρὰ ἀσπιδίσκια κεκρυμμένα, καὶ τὰ τούτων εὐογκότερα ἐν σαργάναις⁵ ἀσταφίδων καὶ σύκων πληρέσι, ἐγχειρίδια δὲ ἐν ἀμφιφορεῦσι⁶ πυρῶν καὶ ἰσχάδων καὶ ἐλαιῶν, τὸν δὲ τῆς ἐπιβουλῆς ἡγεμόνα φρυγάνων ἐν ἐμφορήματι. καὶ εἰ μὲν μὴ γνωσθεῖεν⁷ ὑπὸ τῶν ἐν τῇ πόλει, νυκτὸς γινομένης ἀθροίζεσθαι τοὺς ἐπιθησομένους δεῖ⁸ καιρῶ ἐν ᾧ οἰνοῦνται οἱ πολῖται. καὶ πρῶτον μὲν λυθήτω⁹ τὸ φόρημα διὰ τὸν ἡγεμόνα, ἔπειτα τοὺς ἄλλους τὰ ἄλλα λύσαντας δεῖ λαμβάνειν, καὶ τοὺς ἀμφιφορέας συντρίβειν διὰ τὸ συντόμως ἐπαίρειν· ἀπὸ σημείου τε¹⁰ ἕκαστον προσηκόντως ὀπλίζεσθαι. καὶ τούτων τινὰς ἔχεσθαι πύργων τε καὶ τῶν τοῦ τείχους πυλῶν· καὶ πύργων μὲν διὰ τὸ διὰ σκάλης ἐτέρους ἀναδέχεσθαι, πυλῶν δὲ διὰ τὸ εἰσδέχεσθαι· καὶ τοὺς ἄλλους εἰς τε τὰ ἀρχεῖα¹¹ καὶ τὰς πολεμίας¹² οἰκίας¹³ εἰστρέχειν.¹⁴ εἰ δὲ πρὸ τῆς ἐσπέρας γνωσθεῖεν, τοῦ ἔργου δεῖ παραυτίκα¹⁵ τούτους¹⁶ ἔχεσθαι καθὼς προεδηλώθη· οὐ γὰρ ἄλλως εὖ βουλευσῆ.

¹ R. Schöne: *ei ταῦτα* MSS.

² Aeneas: *ρίπτοις* MSS.

³ Köchly and Rustow in Aeneas: *ιστοῖς* MSS.

⁴ Aeneas: *ἀγεσιν* MSS.

⁵ Aeneas: *σπαργάναις* MSS.

⁶ ἀμβιφορεῦσι, ἀμφιβορεῦσι MSS.

FRAGMENTS

and inspecting them, will appraise them as mere clothing. Then these must be brought in, and set at the edge of the market-place; and also in crates and wicker-frames and wrapped in half-woven sailcloth spears and javelins, and, in baskets of chaff, bucklers and small shields concealed, and the things that are smaller than these in baskets full of raisins and figs, as well as daggers in jars of wheat and dried figs and olives, and the leader of the plot in a load of fagots. And if they should not be discovered by the men in the city, then, when night has fallen, those who are to make the attack should be assembled at a time when the citizens are intoxicated. And first of all the load is to be loosened, so as to get the leader, then the others must unpack and take the rest of the things, and smash the jars so as to get the contents quickly, and at a signal each is to arm himself appropriately. And some of these men are to seize the towers and the gates of the wall—the towers so as to take up others by a ladder, and the gates so as to let them in—while the rest should run to the city hall and the houses of their opponents. But if they should be discovered before evening, they must begin at once as already set forth; for any other course would be ill-advised.

⁷ Editors: ἡ μὲν μὴ ἐγνώσθη MSS. (The text before Boivin had εἰ.)

⁹ R. Schöne: λυθῆ MSS.

¹¹ Boivin: ἀρχαῖα MSS.

¹³ Boivin: οἰκείας MSS.

¹⁵ Boivin: παρ' αὐτὰ MSS.

⁸ Boivin: δὴ MSS.

¹⁰ Boivin: σημειοῦται MSS.

¹² Editors: πολέμου MSS.

¹⁴ Cod. Paris. 2441.

¹⁶ Editors: τούτου MSS.

AENEAS TACTICUS

LI. Περὶ κρυφίας ἐπιστολῶν εἰσομπῆς (= Ch. 31. 4 f.)

Τοῖς κεκρημένοις προδόταις ἀναγκαῖον εἶδέναι πῶς ἐπιστολὰς δεῖ αὐτοὺς εἰσπέμπειν. ἀπόσπελλε γούν οὕτως. πεμπέσθω ἀνὴρ ἐν τῷ φανερώ φέρων¹ ἐπιστολήν τινα περὶ ἄλλων πραγμάτων. τοῦ δὲ πορεύεσθαι μέλλοντος κρυφαίως αὐτοῦ εἰς τὸ τῶν ὑποδημάτων πέλημα ἐντεθήτω εἰς τὸ μεταξὺ βιβλίον καὶ καταραπτέσθω· πρὸς δὲ τοὺς πηλοὺς καὶ τὰ ὕδατα εἰς κασσίτερον ἐληλασμένον² γραφέσθω πρὸς τὸ μὴ ἀφανίζεσθαι ὑπὸ τῶν ὑδάτων τὰ γράμματα. ἀφικομένου δὲ πρὸς ὃν δεῖ³ καὶ ἀναπαυομένου νυκτὸς ἀναλύετω τὰς ραφὰς τῶν ὑποδημάτων καὶ ἐξελὼν ἀναγνούς τε καὶ⁴ ἄλλα γράψας λάθρα ἀποσπελλέτω τὸν ἄνδρα, ἀνταποστείλας καὶ δούς τι⁵ φέρειν φανερώς· οὕτως γὰρ οὔτε ἄλλος οὔτε ὁ φέρων εἰδήσει.

LII. Ἐτερον ἄλλο πανουργότερον (= Ch. 31. 16-19)

Ἄστραγάλον εὐμεγέθη δεῖ σε τρυπήσαι τρυπήματα κδ, ἐξ⁶ εἰς ἐκάστην πλευρὰν τοῦ ἀστραγάλου· ἔστω δὲ τὰ τρυπήματα στοιχεῖα. διαμνημόνευε δὲ ἀφ' ἧς ἂν πλευρᾶς ἀρξῆται τὸ ἄλφα καὶ τὰ ἐχόμενα ἅπερ ἐν ἐκάστη πλευρᾷ γέγραπται. μετὰ δὲ ταῦτα ὅταν τινὰ θέλῃς ἐν αὐτῷ τίθεσθαι, λίνῳ δῆσαι. διαιροῦντα⁷ δὲ δηλοῦν ἐν τῇ τοῦ λίνου διέρσει,⁸ ἀρξάμενος ἐκ τῆς πλευρᾶς τοῦ ἀστραγάλου, ἐν ἧ τὸ ἄλφα ἐστί, παρελθὼν τὰ ἐχόμενα

¹ Boivin: φανερῶν mss.

² Meineke on Aeneas: ἠλασμένον mss.

³ Later mss.: δὴ earlier mss.

⁴ Boivin: τὰ mss.

FRAGMENTS

LJ. *On the secret Sending of Messages*

Those who employ traitors must know how they should send in messages. Dispatch them, then, like this. Let a man be sent openly bearing some message about other matters. Let the letter be inserted without the knowledge of the bearer in the sole of his sandals and be sewed in, and, to guard against mud and water, have it written on beaten tin so that the writing will not be effaced by the water. And when he reaches the one intended and goes to rest for the night, this person should pull out the stitches of the sandals, take out and read the letter, and, writing another secretly, let him send the man back, having dispatched some reply and having given him something to carry openly. For in this way no one else, not even the messenger, will know the message.

LII. *Yet another shrewder Device*

In a sufficiently large astragal you must bore twenty-four holes, six on each side. Let the holes stand for letters, and note clearly on which side begins Alpha and which of the following letters have been written on each particular side. Then whenever you wish to make some communication by means of it, tie a thread to it. And you are to make clear your differentiation between the letters by the drawing through of the thread, beginning from the side of the astragal on which Alpha is found, omitting the characters placed next to Alpha

⁵ Boivin: τε MSS.

⁶ Aeneas: ἐξ ὧν MSS.

⁷ Editors: διαποδνραι MSS.

⁸ Casaubon on Aeneas: διαπέσει MSS.

AENEAS TACTICUS

τούτου¹ γράμματα, ὅταν ἔλθῃς εἰς πλευρὰν οὐ τὸ ἰῶτα γράμμα ἐστί, δίειρον² καὶ πάλιν παρεῖς τὰ ἐχόμενα, ὅπου τὸ νῦ³ εἶναι συμβαίνει δίειρον,² καὶ οὕτως τὰ τοῦ λόγου ἀντιγραφείειν ἂν εἰς τὰ⁴ τρυπήματα. δεήσεται δὲ τὸν ἀναγινώσκοντα ἀναγράφεσθαι εἰς δέλτον τὰ⁵ δηλούμενα γράμματα ἐκ τῶν τρυπημάτων, ἀνάπαλιν γινομένης τῆς ἐξέρσεως⁶ τῇ ἐνέρσει.⁷

LIII. Ἔτερα περὶ τούτου παρὰ τῶν παλαιῶν πραχθέντα (= Ch. 31. 31 f.; 31. 23; 31. 14; 31. 33; 31. 24)

Ἐπέμφθη γράμματά ποτε πολλάκις κατ' Ἡπειρον⁸ οὕτως χρησαμένων αὐτῶν. κυνὶ δεσμὸν⁹ τεθεικότες περὶ τὸν αὐχένα ἐνέβαλον τοῦ ἱμάντος ἔσωθεν ἐπιστολὴν, εἶτα¹⁰ νυκτὸς τοῦτον ἀφήκαν ἢ μεθ' ἡμέραν πρὸς ὃν ἐξ ἀνάγκης ἤμελλεν ἦξειν, ὅθεν ἀπηνέχθη. ἔστι δὲ τοῦτο Θετταλόν.

(31. 23) Ἄλλοι τινὲς εἰς βιβλίον γράψαντες ὡς λεπτότατον μακροὺς στίχους καὶ λεπτὰ γράμματα, ἵνα εὐογκότατα γένηται, εἶτα¹¹ ἐπὶ τοῦ ὤμου τοῦ χιτωνίσκου ὑποθέντες καὶ ἀποπτύξαντες, ἀνυποπτον ἐποιοῦν τὴν κομιδὴν τῆς ἐπιστολῆς.

(31. 14) Ἄλλοι πάλιν ἐν τῷ τῆς δέλτου ξύλω γράψαντες κηρὸν ἐπέτηξαν καὶ ἄλλα εἰς τὸν κηρὸν ἔγραψαν. εἶτα ὅταν ἔλθῃ¹² παρ' ὃν δεῖ¹³ τὸν κηρὸν

¹ Hercher on Aeneas: τοῦ ἰῶτα mss.

² Aeneas: διήρον mss.

³ Orelli and Williams on Aeneas: ὅπου εἶναι mss.

⁴ Boivin: ἀντιγράφεειν ἀριστα mss. (ἀντιγράφει ἐν P¹).

⁵ Aeneas: δέλτα τὸν mss.

⁶ Boivin: ἐξισώσεως mss.

⁷ Casaubon on Aeneas: ἐνάρξει mss.

FRAGMENTS

when you come to the side where the letter Iota is marked, pass the thread through, and again, disregarding the characters following this, pass the thread through where Nu happens to be, and thus the elements of the word would be indicated in the holes. And it will be necessary for the one who is to read the information to write down upon a tablet the characters revealed by the holes, the unthreading taking place in the reverse order to that of the threading.

LIII. *Other Devices for this from the Ancients*

Letters were often sent in Epirus by the employment of the following method. After getting a collar around a dog's neck, they placed inside the strap a letter; then at night or during the daytime they dispatched the dog to the person to whom he was sure to go, that is, to the one from whom he had been brought. And this is a Thessalian custom.

Certain others, by writing long lines with fine characters upon some very thin papyrus, so that they may be as compact as possible, then by placing it on the shoulder under the over-tunic and spreading that out, have caused the letter to be transmitted without suspicion. Others, again, after writing on the wooden part of the tablet, have poured wax over it and written something else on the wax. Then when it came to the appointed person, he, scraping

⁸ Aeneas: *κατήπειρον* MSS.

⁹ Boivin: *δεσμῶν ἢ δεσμῶν* MSS.

¹⁰ Added by Boivin.

¹¹ Aeneas: *εἰς τὸν* MSS.

¹² Aeneas: *ὅτε ἦλθε* MSS.

¹³ Aeneas: *δὴ* MSS.

AENEAS TACTICUS

ἐκκινήσας¹ καὶ ἀναγνοὺς ὁμοιοτρόπως ἀνταπέστειλεν.
(31. 33) ἐγὼ δὲ τὰς παραγνομένας δέλτους² εὐθὺς
ἀνοίγειν παραινῶ, (31. 24) διότι τὰ εἰσπεμπόμενα
μετὰ ἐπιβουλῆς πάνυ χαλεπὸν φυλάξαι.

LIV. Ὑπορυσσόντων γνώσις καὶ κώλυσις (= Ch. 37. 1-4)

Δεῖ τοὺς ὑπορύσσοντας ὧδε κωλύειν. εἴαν
δοκῆ ὑπορύσσεσθαι, ὡς βαθυτάτην³ χρή τὴν
ἐκτὸς τάφρον ὀρύσσεσθαι, ὅπως εἰς τὴν τάφρον
τὸ ὑπόρυγμα ἀφίκηται καὶ οἱ⁴ ὑπορύσσοντες
ὀφθῶσιν. εἴαν δέ σοι ὑπάρχη καὶ τειχίον τειχίσαι
εἰς αὐτὴν ὡς ἰσχυροτάτων καὶ μεγίστων λίθων.⁵
εἴαν δὲ μὴ ὑπάρχη τειχίσαι λίθοις, ξύλων φορυτὸν⁶
κόμιζε. εἴαν δὲ τὰ ὑπορύγματα τῇ τάφρῳ
προσπέση, ἐμβάλλων τὸν⁷ φορυτὸν ἔμπρησον καὶ
τὰ ἄλλα κατασκέπασον, ὅπως ὁ καπνὸς εἰς τὸ
διόρυγμα πορεύσῃται καὶ κακῶς ποιῆ⁸ τοὺς ἐν
τῷ ὀρύγματι ὄντας· συμβαίνει γὰρ πολλοὺς ὑπὸ
καπνοῦ ἀπολέσθαι. λυμανεῖ δὲ τοὺς ὑπ-
ορύσσοντας⁹ σφήκας καὶ μελίσσας ἀφείς εἰς τὸ
διόρυγμα. χρή δὲ καθ' ὃν ἂν ὀρύσσουσι τόπον
ἀντορύσειν καὶ ὑπαντᾶν.

LV. Περὶ τοῦ τοὺς ὑπορύσσοντας μὴ βλάπτεσθαι (= Ch. 37. 8 f.)

Τοῖς ὑπορύσειν μέλλουσι οὕτως ἂν γένοιτο
περίφραγμα ἰσχυρώτατον. χρή δύο ἀμαξῶν τοὺς

¹ Aeneas: ἐκκινήσας MSS.

² Added by the editors from Aeneas.

³ Aeneas: βαθὺ MSS.

⁴ Added from Aeneas.

⁵ Aeneas: μεγιστοτάτων MSS.

⁶ Aeneas: ξυλοφευκτὸν MSS.

FRAGMENTS

off the wax and reading the writing, sent back a reply in a similar manner. And I advise that letters be opened as soon as received, because it is very difficult to guard against anything sent in by artifice.

LIV. *Detection and Prevention of Mines*

Those who are constructing mines must be prevented in the following manner. If it appears that a mine is being made you should dig the moat outside the wall as deep as possible, so that the mine may open into the moat and those who are digging it may be exposed to view. And if you have a chance, a wall should also be built in the moat, of the very hardest and largest stones available. But if you have no chance to build a stone wall, bring up logs and rubbish. And if the mines open into the moat, dump the rubbish, set fire to it, and cover the rest over in order that the smoke may penetrate the opening and injure those in the mine, for it happens that many are killed by smoke. And by releasing wasps and bees into the opening one will work mischief with those in the mine. One must, at whatever point the enemy are digging, construct a countermine and oppose them.

LV. *To protect from Injury those who are digging Mines*

For those who are to construct mines a very effective form of protection would be this. One

⁷ Boivin: ἐμβάλλοντας MSS.

⁸ Aeneas: ποιεί MSS.

⁹ R. Schöne (κατορύσσοντας or ἀντορύσσοντας Boivin):
τορύσσον τὰς MSS.

AENEAS TACTICUS

ῥυμούς εἰς ταὐτὸ συνδῆσαι, συμπετάσαντα κατὰ τὸ ἕτερον μέρος τῆς ἀμάξης, ὅπως μετεωρισθῶσιν οἱ ῥυμοὶ εἰς ταὐτὸ νεύοντες. ἔπειτα οὕτως ἐπισυνδεῖν ἄλλα ξύλα τοῖς¹ ῥυμοῖς καὶ ἄλλα περιφράγματα ἐπάνω, τὰ δὲ πηλῶ καλύψαι. εἴη ἂν οὖν τοῦτο² προσάγειν ὅπου βούλει τοὺς τροχοὺς καὶ ἀπάγειν,³ ὑπὸ δὲ τούτῳ τῷ φράγματι τοὺς ὑπορούσσοντας εἶναι.

LVI. Δολιεύμα (=Ch. 39. 1 f.)

Τοὺς πολιορκουμένους οὕτως δεῖ δολιεύεσθαι ἐν ταῖς πύλαις εἰς τὸ ἔσω μᾶλλον μέρος ὀρύξαντας τάφρον ἔνθεν καὶ ἔνθεν πάροδον λιπεῖν καὶ προάγειν τῶν πολεμίων, ὥστε τινὰς συνδραμεῖν εἰς τὴν πόλιν. χρὴ γοῦν ἔνθεν καὶ ἔνθεν παρὰ τὰς λελειμμένας⁴ παρόδους εἰστρέχειν. τοὺς δὲ τῶν πολεμίων συντρέχοντας εἰκὸς ἐστὶν ἐμπεσεῖν μὴ⁵ προειδότας τὴν τάφρον κεκρυμμένης αὐτῆς οὔσης.

LVIa. "Ἄλλο δι' οὐπερ ὅσους ἂν θέλωμεν τῶν πολεμίων κατάσχωμεν (=Ch. 39. 2-4)

Τῶν εἰσερχομένων πολεμίων ὅσους κατέχειν βουλευθῶμεν ἂν, οὕτως⁶ ποιήσωμεν. εἰάσωμεν εἰσιέναι ὅσους ἂν ἡμῶν ἢ⁷ εὐχερὲς κτεῖναι· προετοιμάσθω δὲ ἄνωθεν ἀπὸ τοῦ μεσοπύλου ἔσω⁸ τῶν πυλῶν πύλη⁹ ὡς παχυτάτη· καὶ σεισιδη-

¹ Editors: ἰ mss.

² Editors: εἴη οὖν τούτους mss. (τούτο Boivin).

³ Boivin: ἐπάγειν mss ⁴ Aeneas: λελημμένας mss.

⁵ Added from the text of Aeneas.

⁶ Editors: οὕτως ἂν mss.

⁷ Editors: ἐστὶν mss.

FRAGMENTS

should fasten together the poles of two wagons, having first turned them back each in the direction of the other part of its wagon in such a way that the poles may be raised aloft, inclining toward the same point. Then, when this has been done, one should fasten on to the poles in addition other timbers and sorts of covering above, and cover them over with clay. This device, then, could be advanced and withdrawn on its wheels wherever you desire, and those who are excavating could keep under this protection.

LVI. *A Stratagem*

Those undergoing siege ought to contrive thus. At the gateway and somewhat within it they should dig a trench and leave a passage on this side and on that, and should lure some of the enemy to make a dash into the town with them. Of course they must themselves run in along the passages that have been left on either side. But it is likely that those of the enemy who run in with them, being unaware of the trench, since it is concealed, will fall in.

LVIa. *Another Method by which we may catch as many of the Enemy as we please*

However many of the enemy we may wish to catch as they come in—let us do it in this way. Let us allow to enter as many as it is convenient for us to kill. You should have ready inside, above the centre of the gate, as stout a portcullis as possible,

⁸ Editors: *ξωσ* MSS.

⁹ Added by the editors from *Acneas*.

AENEAS TACTICUS

ρῶσθαι αὐτὴν ἢ¹ ὅταν οὐ βούλη ὑπολαβεῖν τοὺς εἰστρέχοντας πολεμίους σχῆ. ταύτην ἄφες ὀρθὴν καὶ αὐτὴ τέ τινας ἢ πολλοὺς φερομένους διαφθερεῖ² καὶ τοὺς πολεμίους σχήσει³ μὴ εἰσιέναι· ἅμα δὲ καὶ οἱ ἐπὶ τῷ τείχει βαλλέτωσαν πρὸς⁴ ταῖς πύλαις πολεμίους.

LVII. Πῶς δι' ὀλίγων ἀνθρώπων μεγάλης πόλεως φυλακὴ γενήσεται (= Ch. 40. 1 ; 40. 4 f.)

Ἐὰν ἡ πόλις μεγάλη ᾖ, καὶ μὴ ἱκανοὶ ᾦσιν οἱ ἐν τῇ πόλει ἄνθρωποι περιμίστασθαι καὶ κυκλοῦν τὴν πόλιν, τοῖς δὲ ὑπάρχουσι θέλης αὐτὴν διαφυλάξαι, δεῖ τῆς πόλεως ὅσα ἂν ᾖ εὐπρόσοδα οἰκοδομεῖν ὑψηλὰ ἐκ τῶν ὑπαρχόντων, ὡς εἰάν τις τῶν πολεμίων βία ἢ λάθρα ἀναβῶσιν ἐν ἀπειρίᾳ γινόμενοι μὴ δύνωνται καταπηδᾶν. παρὰ δὲ τὰ οἰκοδομημένα⁵ ἔνθεν καὶ ἔνθεν φυλασσόντων οἱ ὑπάρχοντες ἄνθρωποι, ἵνα τοὺς καταπηδῶντας ἀπὸ τῶν ὑψηλῶν διαφθείρωσιν. (40. 4 f.) ἀλλὰ μὴν καὶ γυναιῶν ἐνότων καὶ γερόντων καὶ παιδαρίων, τούτων ἐπιεικέστατα σώματα διαμορφοῦν καὶ ὀπλίξιν ὡς εἰς ἄνδρας μάλιστα. ἀντὶ δὲ ὀπλων δίδοναι τοὺς τε κάδους⁶ καὶ τὰ τούτοις ὁμότροπα δόντας⁷ χαλκῶματα περιάγειν τοῦ τείχους, βάλλειν δὲ ἢ καὶ ἀκοντίζειν μηδαμῶς εἶν· κατάδηλον γὰρ γύναιον πόρρωθεν βάλλον.⁸

¹ Editors: ὡς καὶ . . . ἢ MSS. (ἢ Boivin).

² Capps from Orelli on Aeneas: διαφθελεῖ MSS.

³ Added from Aeneas.

⁴ Aeneas: πρὸ MSS.

⁵ Aeneas: οἰκοδομημένα MSS.

FRAGMENTS

and this should be overlaid with iron, so that when you do not wish to admit the enemy as they run in, it may keep them from entering. Drop this, and the portcullis itself not only will destroy some few or many of them as they sweep in, but also will keep the foe from entering; at the same time let the forces on the wall keep shooting at the enemy by the gate.

LVII. How a large City can be guarded by a few Men

If the city is a large one and the men in it are not numerous enough to man its walls all the way around, and yet you wish to keep it closely guarded with the men you have, you must from the materials at hand build up high all the easily assailable parts of the city wall, so that, if any of the enemy shall scale it, either by force or by stealth, from their unfamiliarity they may not be able to leap down. And on either side of the parts that have been built up the available men should keep watch to destroy those who may leap from the high points. Moreover, you should disguise the most able-bodied of the women, old men, and boys that are in the town, and arm them as much like men as you can. And in place of arms give them their jars and similar bronze utensils, and march them around the wall, but do not by any means allow them to throw missiles or yet to hurl a javelin, for even a long way off a female betrays her sex when she tries to throw.

⁶ Aeneas: κλάδους MSS.

⁷ Aeneas: δόντες MSS.

⁸ Editors from Aeneas: μάλλον MSS.

ÆNEAS TACTICUS

LVIII. Περὶ τοῦ στρατιώτας ὀλίγους ὄντας πολλοὺς φαίνεσθαι (= Ch. 40. 6 f.)

Ἐὰν ἐπὶ τῷ τείχει ἢ χάρακι βούλη τοὺς περιόδους πλείω τῶν ὄντων φαίνεσθαι, χρὴ περιέναι ἐπὶ δύο, ἔχοντας τὰ δόρατα τὸν πρῶτον στίχον ἐπὶ τῷ ἀριστερῷ ὤμῳ, τὸν δὲ ἕτερον ἐπὶ τῷ δεξιῷ· καὶ οὕτως φανοῦνται εἰς τέσσαρας. ἔὰν δὲ ἐπὶ¹ τρία περιῶσι,² τὸν μὲν πρῶτον ἄνδρα ἐπὶ τῷ δεξιῷ ὤμῳ ἔχειν τὸ δόρυ, τὸν δὲ ἕτερον ἐπὶ τῷ ἀριστερῷ, καὶ οὕτω φανοῦνται εἰς³ δύο.

¹ Added by Boivin.

² Later mss. : περιῶσι earlier mss.

³ Aeneas : εἰς mss.

FRAGMENTS

LVIII. *How Soldiers who are few may appear to be many*

If you wish the patrolmen upon the wall or rampart to appear more numerous than they are, you should make them go their rounds two abreast, the first rank with their spears upon the left shoulder, the other with their spears upon the right, and thus they will appear to be four abreast. And if they go about three abreast, the first man should have his spear upon his right shoulder, the next upon his left, and in this way each man will look like two.

ASCLEPIODOTUS

PREFACE

THE text of Asclepiodotus in the present edition was prepared by W. A. Oldfather, the remainder of the work by W. A. Oldfather and C. H. Oldfather jointly. Much important assistance was given in the numerous difficulties which such an undertaking affords by Messrs. Arthur Stanley Pease and John B. Titchener, and Major T. J. Camp, to whom we hereby tender our grateful acknowledgements, but we assume full responsibility for all errors.

Because of certain obvious differences between Greek and modern tactics, the *termini technici* have been a special source of embarrassment, and we do not claim that our rendering of them gives, in every instance, anything more than an approximate equivalent. The precise technical significance of the modern terms employed should not everywhere be pressed, but their proper meaning will always, we trust, be clear from the context.

CHARLES HENRY OLDFATHER
WILLIAM ABBOTT OLDFATHER

April 30, 1920

INTRODUCTION

IN a manuscript of the tenth or eleventh century, now at Florence, is found the *Outline of Tactics by Asclepiodotus the Philosopher*. The early date of this manuscript, which is the archetype of all the others which contain this work, can leave little doubt that the name is genuine. When we come, however, to inquire further about the author, we find no certain landmarks. Among the men of that name in antiquity he can be identified, with any degree of probability, only with the Asclepiodotus who is mentioned in five places by Seneca in his *Naturales Quaestiones* as a source for his illustrations, in two of which he is further described as a pupil (*auditor*) of Poseidonius. That he stood in such a relation to the great Stoic is all the more probable since Aelian in the beginning of his work on tactics says that Poseidonius also wrote on the same subject, giving the title of his work as Τέχνη τακτική.¹ We know from

¹ This work by Poseidonius must have been in the mind of Philodemus, his younger contemporary, when he raised the question in his *Περὶ τοῦ καθ' Ὁμηρον ἀγαθοῦ βασιλέως*, p. 33 ed. Olivieri (1909), εἰ δὲ τῷ φιλοσόφῳ πρέπει τὰ περὶ στρατεύματος εὐπρεπῶς καὶ δι' εὐκοσμίας γράφειν. Unfortunately the lines immediately following are so injured that we cannot tell what his answer was. But he proceeds to present the views of Homer on the same subject at some length, and can hardly, therefore, in principle have denied the propriety of a philosopher handling the question.

INTRODUCTION

Seneca that on other subjects, such as earthquakes and volcanic eruptions, Asclepiodotus wrote along the same lines as his master, and he may very well have followed him into the field of military science.

After Aeneas Tacticus, who belongs to the earlier group of military writers, Asclepiodotus, the earliest among the later tacticians, is the first whose work has come down to us. While the former was in all probability a general, or at least a man intimately acquainted with military affairs, in the case of the latter we find that the discussion of tactics has become the subject matter for lectures by philosophers and theorists. Nor is this without good reason. Aeneas wrote in the middle of the fourth century B.C., when the quarrels and battles of Greek states were still the most important political events of the Mediterranean world, and the Greek phalanx was of all battle arrays the most formidable; Asclepiodotus wrote when no Greek state possessed a military establishment of any power and the cumbersome phalanx had long since bowed before the mobile maniples of Italy. A spirited treatment, therefore, of the old Greek phalanx could hardly be expected. No treatment of the subject, indeed, would have been written at all had not the philosophers in laying claim to all branches of learning included tactics as well.¹ The tramp of the phalanx, that had once

The sad experience of the Peripatetic Phormio, who undertook to instruct even Hannibal at the court of Antiochus *de imperatoris officio et de omni re militari*, is reported at length by Cicero, *De oratore*, ii. 75 f.

¹ This seems to have been true, in particular, of Poseidonius, who found the basis of all practical affairs, even of carpentry and bread-making, in philosophy. Cf. Seneca, *Epist.* lxxxviii. 21 ff.; xc. 7 ff.

ASCLEPIODOTUS

reverberated among the hills around Thermopylae and Marathon, now echoed feebly in the halls of theorists and rhetoricians.

A corresponding flagging of interest would be expected in the form of the discussion also, and in consequence the style of Asclepiodotus does not cause surprise. There is not a single illustration drawn either from history or from experience ; little effort is made to vary the almost inevitable monotony of a treatise on such a subject ; the sentences are short and stiff, the language unimaginative ; not even an extra sentence is spent upon an introduction. The whole is a dry, but most orderly, exposition of the different branches of the army, their equipment, their number, their manœuvres, etc. So sketchy, indeed, is this little work of twelve chapters, that those who hold that Asclepiodotus merely edited the work of his master, think it the outline of the latter's lectures which he amplified before his class ; and the nature of the treatise to some extent bears out their contention : no historical material to confuse the pupil, everything very clear, the most important facts stressed, diagrams and figures employed. It would thus be very similar to the material dictated by the medieval professor to his students, and then lectured upon. In a sense it is a study only of antiquarian interest, as was freely confessed by Aelian in the introduction to his work, a funeral oration upon the past glory of the Grecian Phalanx, although, without the personal interest of the orator, it becomes rather the coroner's stilted verdict on a tragic death.

It would be a mistake, however, to think too lightly of the value of even these late theoretical works

INTRODUCTION

upon phalanx tactics. They must consist in large part of quotations from early military handbooks, and these quotations are of the utmost historical value, even though they may be sometimes misunderstood, improperly elaborated, and occasionally treated in too theoretical a fashion. The materials for a reconstruction of Macedonian tactics are after all in a large measure preserved here, and it is the proper task of criticism to understand and interpret them. This attitude which Lammert takes (see Bibliography), in contrast with the occasionally almost supercilious comments of Köchly and Rüstow, is, without a doubt, the proper one to assume towards the later tacticians.

In a papyrus of Herculaneum containing an index of Stoic philosophers there appears a certain Asclepiodotus of Nicaea, son of Asclepiodotus and pupil of Panaetius. Comparetti in his reconstruction of the lines following reads 'who was also a pupil of Poseidonius.'¹ The reading was attractive and was accepted by Gomperz, Diels, and Suscnihl, notwithstanding considerable chronological difficulties. For Panaetius died in 110-109 B.C., and the dates of birth and death for Poseidonius are given as 135 (or 130)-51 (or 46) B.C., the earlier date allowing him to be about twenty-five years of age when his teacher died. If Asclepiodotus was the pupil of both Panaetius and Poseidonius, he would have had to be nearly as old as his second teacher, and survive him, writing his edition of his master's *Tactics* after the latter's death at the advanced age of eighty-four. That Asclepiodotus attained such an age is possible, but the attempted identification of the

¹ *Rivista di filologia*, 1875, iii. 543.

ASCLEPIODOTUS

pupil of Panaetius with the pupil of Poseidonius will probably have to be given up since Crönert has shown that Comparetti's reconstruction of the text is impossible.¹ The lines, properly restored, merely inform us that the pupil of Panaetius 'also visited Rome,' and so Zeller's insistence upon an older philosopher Asclepiodotus, a pupil of Panaetius, and a younger, a pupil of Poseidonius, is probably justified. It is unlikely that Asclepiodotus was older than his teacher, nor could he have been much younger than twenty-five in 51 (or 46) B.C. when Poseidonius died, since a younger man would scarcely have won the distinction of being one of the three pupils of Poseidonius and have been able to continue his master's work. The date of his birth, therefore, must fall somewhere in the period 135 (or 130)–76 (or 71) B.C.²

¹ *Sitzb. d. k. preuss. Ak. d. Wiss.*, 1904, 480.

² It is not, indeed, impossible for Asclepiodotus to have been a pupil of Panaetius and Posidonius and to have survived the latter, for this was the relation of Philippus of Opus to Socrates and Plato, and Plato lived to be at least eighty years of age. Philippus was *Σωκράτους καὶ αὐτοῦ Πλάτωνος ἀκουστής* (Suidas), and survived Plato, editing his *Laws* and adding thereto his own *Epinomis* (*Philologus*, 1908, lxvii. pp. 452 ff.). The determining reasons, however, for rejecting the identity of those Asclepiodoti are that Asclepiodotus the pupil of Panaetius being listed immediately after one who died during his master's lifetime, is presumably to be reckoned among the older pupils and not the very youngest (so Crönert); and that in the very brief remarks characterizing the several pupils, surely if this Asclepiodotus had been the pupil also of Poseidonius and edited certain works of his, that circumstance would much more naturally have been selected for purposes of characterization than the trivial fact that he also visited Rome.

INTRODUCTION

Our knowledge, then, of Asclepiodotus, the author of the present work, is limited to the five times Seneca mentions him, and to any inferences we may draw from his *Tactics*. From the latter we may well conclude that he was not a military man, nor even greatly interested in military matters, for a real enthusiasm for one's subject cannot be consistently repressed into such a cold and methodical style; rather he was a chair-strategist, as Köchly and Rüstow denominate him, although not all their strictures are just. He was rightly termed 'the philosopher,' for certain sections of his work can scarcely be brought down from the heaven of pure theory. So, for instance, his repetition of the advice of 'most tacticians' that the phalanx consist of 16,384 men, since this number is evenly divisible by two down to unity; his strong dependence upon mathematical forms and proportions, so that one feels that he is dealing more with numbers than with men, his pedantic divisions of the chariots and elephants,¹ or his elaborations upon the array of an army in march, some of which are obviously impracticable and of use only on the drill-ground.²

From the citations in Seneca it appears that he continued the meteorological studies of his teacher. Of the five references, three have to do with phenomena attendant on earthquakes and volcanic eruptions,³ one with the nature of winds,⁴ and the last with the character of subterranean water.⁵ All these subjects fall quite properly under the

¹ Ch. viii. 10.

² Ch. xi. 1.

³ Seneca, *Quaest. nat.* ii. 26. 6; 30. 1; vi. 22. 2.

⁴ *Ibid.* vi. 17. 3.

⁵ *Ibid.* v. 15. 1.

ASCLEPIODOTUS

title of his work as given by Seneca, *Causes of natural Phenomena*.¹

The work of Asclepiodotus was drawn upon by the tactician Aelian, who wrote in the time of the Emperor Trajan, to whom he dedicated his discussion of tactics. In connexion with this use by Aelian arises a most interesting question. In his opening chapter, Aelian mentions by name several writers, who had published works in more recent times on tactics, such as Aeneas, Cineas, Pyrrhus of Epirus and his son Alexander, Clearchus, Poseidonius, and others, and acknowledges his indebtedness to many whom he does not name. But he makes no mention of Asclepiodotus who was certainly his main source. K. K. Müller gives two possible explanations for his failure to acknowledge such a debt of obligation.² Aelian may include Asclepiodotus under the other writers whom he has read, and intentionally fails, perhaps, to mention his name in order that attention may not be called to the extent of his obligation. Or Asclepiodotus bore a very unusual relation to the work which we have now under his name, a relation well known in antiquity, but obscured in the course of centuries. Because Seneca speaks of Asclepiodotus as if he were the medium through which the teachings of Poseidonius had come to him, and because of parallel instances, Müller feels that Asclepiodotus merely transmitted the work of Poseidonius on tactics, for the knowledge of which Aelian is our only source. Then, as time

¹ *Ibid.* vi. 17. 3 . . . id apud Asclepiodotum invenies, auditorem Posidonii, in his ipsis Quaestionum naturalium Causis.

² Pauly-Wissowa, *Realencyklop.* ii. 1638.

INTRODUCTION

passed, the relations of the master and of his pupil to this work became increasingly obscure and some attributed it to Poseidonius, others to Asclepiodotus. The manuscript preserved to us would thus have come from the latter group, or else part of the original subscription has been lost.

The question how closely Asclepiodotus followed the lost work of Poseidonius must remain unanswered. The *Tactics* have the appearance as much of an abridgement of a larger work as of an outline for lectures—an abridgement in which the author resolved to strike out everything but the cold facts and succeeded only too well. Neither in this subject nor in his work on meteorology are the titles of the books of Asclepiodotus the same as those of his master's, and, as he is quoted in Seneca, there is something to be said for the view that he may have departed at times perhaps widely from the tradition of his teacher.¹

The value of the work depends, of course, upon the use and the nature of its sources. The fact that Poseidonius continued in his history the writings of Polybius, makes it highly probable that the latter's work on tactics was drawn upon, and other writers on tactics, mentioned by Aelian, may well have been put under contribution. But the fact that all these earlier treatises have disappeared, coupled with the cursory nature of the work itself, precludes any answer to this most important question. It must be borne in mind, however, that probably Asclepiodotus, and certainly his master Poseidonius, were not intimately acquainted with the arts of war, and that at all times, and perhaps especially in the Hellenistic

¹ Cf. E. Oder, *Philologus*, *Suppl.* vii., 1899, 302 f.

ASCLEPIODOTUS

period, works of this nature contained much material which was confined to drill-grounds and never intended for actual employment upon the battle-field.¹

BIBLIOGRAPHY

- A. Bauer: Die griechischen Kriegsaltertümer, in Muller's *Handbuch der klassischen Altertumswissenschaft*, iv. 1 (2nd ed.), 279 f., 287, 422, 425, 450.
- W. Capelle: Der Physiker Arrian und Posidonios, *Hermes*, 1905, xl. 633 f.
- W. Capelle: Zur Geschichte der meteorologischen Literatur, *Hermes*, 1913, xlviii. 344 f.
- W. Christ: Griechische Literaturgeschichte, in Muller's *Handbuch der klassischen Altertumswissenschaft*, vii. 2 (6th ed. by Schmid and Stählin), 354, 7.
- D. Comparetti: Papiro ercolanese inedito, *Rivista di filologia*, 1875, iii. 543.
- W. Cronert: Eine attische Stoikerinschrift, *Sitzb. der k. preuss. Akademie der Wissenschaften*, 1904, 480.
- II. Delbrück: Geschichte der Kriegskunst im Rahmen der politischen Geschichte, Berlin, 1901, ii. 1, 200.
- H. Delbrück: Die Perserkriege und die Burgunderkriege, Berlin, 1887, 305 ff.
- II. Delbrück: Die Manipularlegion und die Schlacht bei Cannae, *Hermes*, 1886, xxi. 64-90, esp. 83 ff.
- H. Diels: *Doxographi Graeci*, Berlin, 1879, 19 and 225.
- R. Forster: Studien zu den griechischen Taktikern, *Hermes*, 1877, xii. 431 f.
- F. Haase: Ueber die griechischen und lateinischen

¹ The vexed question of the precise relations of Aelian and Arrian to one another and to Asclepiodotus belongs properly in a discussion of the later authors. Both drew largely from Asclepiodotus.

INTRODUCTION

- Kriegsschriftsteller, *Neue Jahrbücher für Philologie*, 1835, xiv. 115 ff.
- F. Haase: De militarium Scriptorum Graecorum et Latinorum omnium Editione instituenda, Berolini, 1847, 8, 27 ff., 32 ff.
- Max Jähns: Handbuch einer Geschichte des Kriegswesens, etc., Technischer Teil, Leipzig, 1880, 117 ff.
- Max Jähns: Geschichte der Kriegswissenschaften vornehmlich in Deutschland, München und Leipzig, 1889, i. 5 f.; 67 f.; 130 ff.
- H. Kochly: De Libris tacticis, qui Arriani et Aeliani feruntur, Supplementum, Turici, 1852, 33 ff.
- H. Kochly: De Scriptorum militarium Graecorum Codice Bernensi, Diss. Turici, 1854, especially 27.
- H. Kochly and W. Rüstow: Griechische Kriegsschriftsteller, Leipzig, 1855; i. Introduction, Asclepiodotus, Greek text and translation; ii. Introduction and critical notes.
- E. Lammert: Polybios und die romische Taktik, Program des königlichen Gymnasiums zur Leipzig, 1889, 11 ff., especially 13.
- Angelo Mai: Spicilegium Romanum, tomus iv., Romae, 1840. Pages 577-81 contain a reproduction of the first two chapters of the Laurentian ms. as copied by Leo Allatius.
- K. K. Müller: Article "Asklepiodotos," Pauly-Wissowa *Realencyclop.* ii. col. 1637-1641.
- K. K. Müller: Festschrift für L. Urlichs, Würzburg, 1880, 106 f.
- K. K. Müller: Festgabe zur dritten Säcularfeier der Julius-Maximilians-Universität zu Würzburg, Würzburg, 1887, 30 f.
- E. Oder: Quellensucher im Altertum, *Philologus, Supplementband*, 1899, vii. 290 ff.
- F. Osann: Der Taktiker Asklepiodot, *Zeitschrift für die Altertumswissenschaft*, 1853, xi. 311 ff.
- W. Rüstow und H. Köchly: Geschichte des griechischen Kriegswesens von der ältesten Zeit bis auf Pyrrhos, Aarau, 1852.

ASCLEPIODOTUS

- R. Schneider : *Legion und Phalanx*, Berlin, 1893, 70 ff.
S. Sudhaus : *Aetna*, Leipzig, 1898, 61 f.
Franz Susemihl : *Geschichte der griechischen Litteratur in der Alexandrinerzeit*, Leipzig, 1892, ii. 144, 244 f.
E. Zeller : *Die Philosophie der Griechen in ihrer geschichtlichen Entwicklung*, 3rd ed., 1880, iii. 1, 569, 585 ; 4th ed., 1909, iii. 590.

For some other references of minor importance see the detailed list in K. K. Müller's learned and thorough article 'Asklepiodotos,' given above.

EDITION AND MANUSCRIPTS

The only edition of Asclepiodotus is that by H. Köchly and W. Rüstow, Leipzig, 1855 (see Bibliography). It was based upon collations of three Paris mss., but Köchly had no knowledge of the Florentine ms., from which they are descended, Laurentianus LV 4, a parchment codex of the tenth or eleventh century. The present text represents, therefore, a new recension made from a collation of the text of the Florentine ms. and copies of its diagrams, prepared for this purpose by the accomplished scholar Professor Dr. Enrico Rostagno of the Bibliotheca Mediceo-Laurenziana at Florence, to whom we take this occasion to express publicly our great indebtedness. For a brief discussion of the archetype and its descendants, together with some remarks upon the text of Asclepiodotus, those who seek further information may be referred to an article by W. A. Oldfather in *The Amer. Journ. of Philol.*, 1920, xli. 127 ff.

Suffice it to say here that the variant readings in

INTRODUCTION

the descendants have independent value only as emendations, those in the ms. copied by Salmasius being, of course, the most important in this respect. Mere errors and omissions are, therefore, not recorded. Our knowledge of the first three (A, B, C) of these mss. we owe to the *apparatus criticus* in Köchly and Rüstow, of the fourth (V) to Mai's reprint which, although employed by Köchly and Rüstow, was newly collated for this edition, and of the last three to specimen photographs of a few folios from the beginning of each (covering the whole of Chapters i, iv-vi, and parts of ii, iii, and vii), these being sufficient to determine the fact that they are practically worthless.

SYMBOLS

- F = Cod. Laurentianus LV, 4. s. x-xi.
A = Cod. Parisinus 2522. s. xv.
B = Cod. Parisinus 2435. s. xvi.
C = Cod. Parisinus 2528. s. xvii. This ms was copied by Salmasius.
D = Cod. Parisinus 2447. s. xvi.
E = Cod. Parisinus Suppl. Gr. s. xvii. This ms. was copied by P. D. Huet at Stockholm in 1642.
V = Copy of the Laurentian ms. by Leo Allatius, in the Bibliotheca Vallicellana at Rome. Chapters i and ii were printed from this ms. by Angelo Mai, *Spicilegium Romanum*, vol. iv (see Bibliography).

ASCLEPIODOTUS

The text of Asclepiodotus may be not infrequently controlled by the works on tactics which are current under the names of Arrian and Aelian. Whether they derive in part directly from Asclepiodotus, or merely employ in large measure the same sources, has not been decided as yet, but in any event they frequently discuss the same topics in very much the same fashion, and they throw light accordingly upon a number of corrupt or lacunose passages.

In the *Lexicon militare*¹ also we possess an important *subsidiūm* for determining the text. This work of uncertain date, but anterior to the Byzantine period, was drawn in very large part direct from Asclepiodotus, Arrian, and Aelian, numerous passages from whom it repeats *verbatim*, and others with only slight variations. Its quotations from Asclepiodotus, therefore, in so far as they have not themselves become garbled,² give the text as it stood several centuries before the time of F. In a score of cases emendations of F supported by the *Lex. mil.* (so designated in the notes) have been introduced into the present edition, while in two other instances the reading in the *Lex. mil.*, as being more easy and natural, may possibly be correct.

In the notes to the translation we have given references to the treatment of the same general topic in Aelian's *Tactics*. Since, in the edition of

¹ Best edited by Köchly and Rüstow, *Griech. Kriegsschriftsteller*, ii. 2. Leipzig, 1855, 217 ff. It appears ordinarily as an appendix to the lexicon of Suidas. For a discussion of the sources and the text-critical value of the work see a note by W. A. Oldfather and J. B. Titchener in *Class. Philol.*, 1921, xvi, 74-76.

² Thus it gives ἐκτατου like F, alongside of ἐκτακτου in § 14 (= Ascl. ii. 9).

INTRODUCTION

Köchly and Rüstow, Arrian's *Tactics* have the same chapter and paragraph enumeration as Aelian's, we have not thought it necessary to add Arrian's name.

THE DIAGRAMS

A notable feature of the great Florentine ms. is its series of diagrams which go back to Asclepiodotus himself, as is clear from the way in which mention is made of them in the body of the text. These have been reproduced in this edition from tracings prepared by Dr. E. Rostagno. In a few instances where the inscriptions in F have faded since the copies A and B were made, the inscriptions in these latter mss. have been given in the notes. As might be expected in a thousand years or more of copying, a number of demonstrable errors have crept into the diagrams, so that in nearly every instance it has been found necessary to supplement the originals in the text with the reconstructed figures of Köchly and Rüstow in the notes. Even though frequently in one respect or another these diagrams in the ms. are erroneous, it seems desirable to retain them as an indication of the approximate appearance of the work as it left the hand of the author, of the degree to which they have been modified in copying, and of the evidence upon which the revised figures were constructed.

ΑΣΚΛΗΠΙΟΔΟΤΟΥ

ΦΙΛΟΣΟΦΟΥ

ΤΑΚΤΙΚΑ ΚΕΦΑΛΑΙΑ

- α'. Περὶ τῆς φαλάγγων διαφορᾶς.
β'. Περὶ τοῦ ἀριθμοῦ καὶ τῆς ὀνομασίας τῶν μερῶν τῆς φάλαγγος τῶν ὀπλιτῶν.
γ'. Περὶ διατάξεως τῶν ἀνδρῶν τῆς τε καθ' ἑλλην τὴν φύλαγγα καὶ τῆς κατὰ μέρη.
δ'. Περὶ διαστημάτων αὐτῶν.
ε'. Περὶ τῶν ὅπλων τῆς τε συμμετρίας καὶ τοῦ εἶδους.
στ'.¹ Περὶ τῆς τῶν ψιλῶν τε καὶ πελταστῶν φάλαγγος καὶ τῆς τῶν μερῶν τάξεώς τε καὶ ὀνομασίας.
ζ'. Περὶ τῆς τῶν ἰππέων φάλαγγος καὶ τῶν ὀνομασιῶν τῆς τε ὅλης καὶ τῶν μερῶν.
η'. Περὶ ἀρμάτων.
θ'. Περὶ ἐλεφάντων.
ι'. Περὶ τῶν κοινῆ² κατὰ τὴν κίνησιν ὀνομασιῶν.
ια'. Περὶ τῶν ἐν ταῖς πορείαις σχηματισμῶν τῶν κατὰ συντάγματα.
ιβ'. Περὶ τῶν κατὰ τὴν κίνησιν αὐτῶν προσταγμάτων.

¹ ζ' F.

² ΚΟΙΝΗ F.

CHAPTER HEADINGS OF THE TACTICS OF ASCLEPIODOTUS THE PHILOSOPHER

- I. The different Branches of the Army.
- II. The Strength and the Names of the Subdivisions of the Hoplite-Phalanx.
- III. The Disposition of the Men both in the entire Army and in its Subdivisions.
- IV. The Intervals between the Soldiers.
- V. The appropriate Size and Character of the Arms.
- VI. The Phalanx of the light Infantry and of the Targeteers, and the Disposition and Names of its Subdivisions.
- VII. The Phalanx of the Cavalry, and the Names of the whole Body as well as of its Subdivisions.
- VIII. Chariots.
- IX. Elephants.
- X. The Terms in common Use for military Evolutions.
- XI. The various Arrangements of the Divisions of the Army on the March.
- XII. The Commands used in military Evolutions.

ΤΕΧΝΗ ΤΑΚΤΙΚΗ

I. Περὶ τῆς φαλάγγων διαφορᾶς

Τῆς τελείας παρασκευῆς πρὸς πόλεμον διττῆς οὔσης, χερσαίας τε καὶ ναυτικῆς, περὶ τῆς χερσαίας τὰ νῦν λεκτέον. ταύτης τοίνυν τὸ μὲν ἐστὶ μάχιμον, τὸ δ' εἰς τὴν τούτου χρεῖαν ὑπηρετοῦν, οἷον ἰατρῶν καὶ σκευοφόρων καὶ τῶν ὁμοίων.

Τοῦ δὲ μαχίμου τὸ μὲν ἐστὶ πεζόν, τὸ δ' ὀχηματικόν· τὸ μὲν γὰρ ποσὶ χρῆται πρὸς τὴν μάχην, τὸ δ' ἐπὶ τινος ὀχείται.

- 2 Τοῦ δὲ δὴ πεζοῦ τὸ μὲν ἐστὶν ὀπλιτῶν σύστημα, τὸ δὲ πελταστῶν, τὸ δὲ τῶν καλουμένων ψιλῶν. τὸ μὲν οὖν τῶν ὀπλιτῶν ἅτε ἐγγύθεν μαχόμενον βαρυτάτη κέχρηται σκευῇ—ἀσπίσι τε γὰρ μεγίσταις καὶ θώραξι καὶ ταῖς κνημῖσι σκέπεται—καὶ δόρασι μακροῖς κατὰ τὸν ῥηθησόμενον Μακεδόνιον τρόπον· τὸ δὲ τῶν ψιλῶν τούτοις ἀπ' ἐναντίας κουφοτάτη κέχρηται τῇ σκευῇ διὰ τὸ πόρρωθεν βάλλειν, οὔτε προκνημῖσιν οὔτε θώραξι κεκοσμημένον,¹ ἀκοντίοις δὲ καὶ σφενδόλαις καὶ ὄλως τοῖς

¹ κοσμούμενον V (Leo Allatius).

¹ For this use of *φάλαγξ* as applying to any kind of military fighting force (not recorded in the lexica) see below, ch. i. 4.

TACTICS

I. *The different Branches of the Army*¹

WHEREAS the complete equipment for warfare is of two kinds, namely land and naval forces, we are now to speak of the land force. This, then, consists on the one hand of the fighting men, and on the other of those who serve their needs, as, for example, surgeons, baggage-carriers, and the like.

Of the fighting men, some are infantry, the others mounted; for some fight on foot, the others on their mounts.

The infantry is divided into the corps of hoplites, the corps of targeteers, and the corps of so-called light infantry (*psiloi*). Now the corps of hoplites, since it fights at close quarters, uses very heavy equipment—for the men are protected by shields of the largest size, cuirasses, and greaves—and long spears of the type which will here be called ‘Macedonian.’ The corps of the light infantry on the contrary uses the lightest equipment because it shoots from a distance, and is provided with neither greaves nor cuirasses, but with javelins and slings, and in general

Asclep. i. 1 = Ael. ii. 1-3 references to Aelian below
(= Arrian ii. 1-3 in Köchly are understood to include
and Rüstow's parallel Arrian as well).
column edition, so that Asclep. i. 2 = Ael. ii. 7-9.

ASCLEPIODOTUS

ἐξ ἀποστήματος λεγομένοις τοξεύμασιν.¹ τούτων δ' ἐν μέσῳ πῶς ἐστὶ τὸ πελταστικὸν σύστημα· ἢ τε γὰρ πέλτη μικρά τίς ἐστὶν ἀσπιδίσκη καὶ κούφη, τὰ τε δόρατα πολὺ τῶν ὀπλιτῶν μεγέθει λειπόμενα.

- 3 Κατὰ τὰ αὐτὰ δὴ καὶ τῆς ὀχηματικῆς δυνάμεως τρεῖς εἰσι διαφοραί· ἢ μὲν γὰρ ἐστὶν ἵππικὴ, ἢ δὲ δι' ἀρμάτων ἐπιτελεῖται, ἢ τρίτη δὲ δι' ἐλεφάντων· ἀλλ' ἀρμάτων τε περί καὶ ἐλεφάντων ὡς οὐκ εὐφυῶν εἰς μάχην ὁ λόγος εἰς ὕστερον ἀναβεβλήσθω· τὴν δὲ² ἵππικὴν ὡς πολλὴν καὶ παρὰ πολλοῖς καιροῖς χρησιμωτέραν³ ταῖς μάχαις νῦν διελοῦμεν· ἔστι γὰρ αὐτῆς εἶδη τρία, τὸ μὲν τὸ⁴ ἐγγύθεν μαχόμενον, τὸ δὲ πόρρωθεν, τὸ δὲ μέσον· καὶ τὸ μὲν ἐγγύθεν ὁμοίως βαρυτάτη κέχρηται σκευῇ, τοὺς τε⁵ ἵππους καὶ τοὺς ἄνδρας πανταχόθεν θώραξι περισκέπον,⁶ μακροῖς μέντοι⁷ χρώμενον καὶ αὐτὸ τοῖς δόρασιν, δι'⁸ ὁ καὶ δορατοφόρον τοῦτο καὶ ξυστοφόρον προσαγορεύεται, ἢ καὶ⁹ θυρεοφόρον, ὅτ' ἂν καὶ ἀσπίδας ἔνιοι φορῶσι παραμῆκεις διὰ τὸ συνεπισκέπεσθαι¹⁰ καὶ τὸν ἵππον· τὸ δὲ πόρρωθεν μαχόμενον τοξοτῶν τε καὶ Σκυθῶν λέγεται· μέσον δὲ τὸ τῶν καλουμένων ἀκροβολιστῶν, οἳ δὴ τοῖς ἄκροις ἐπικοινων-

¹ σφενδόναις καὶ τοξεύμασι καὶ ὄλως ὄπλοις τοῖς ἐξ ἀποστήματος λεγομένοις K. and R. ² γὰρ C (Salmasius).

³ K. and R.: πολλοῖς καὶ χρησίμως ἐράν F.

⁴ K. and R.: μὲν τι F: μέντοι ABCV.

⁵ μὲν K. and R.: δὲ ABC.

⁶ περισκέπων corrected to -έπον F (first hand probably).

⁷ μὲν F: δὲ K. and R.

⁸ Supplied by Oldfather.

⁹ F has καὶ τοῦτο καὶ in the line above and ἢ θυραιοφόρον here. K. and R. saw that the καὶ belongs after ἢ.

¹⁰ συνεπισκέπεσθαι F: corrected in V (Leo Allatius).

with those missiles which we call 'long-distance missiles.' The corps of the targeteers stands in a sense between these two, for the targe (*pelte*) is a kind of small, light shield, and their spears are much shorter than those of the hoplites.

In the same way there are three branches of the mounted force: the first is cavalry, the second is furnished with chariots, and the third with elephants; but let the consideration of chariots and elephants, since they are not naturally well adapted for fighting purposes, be deferred to a later time, and we shall now discuss the cavalry, since it is much employed and upon many occasions more useful in battles. There are, then, three branches of the cavalry service: the first which fights at close quarters, the second which fights at a distance, and the third which is intermediate. Now the cavalry which fights at close quarters uses, similarly,¹ a very heavy equipment, fully protecting both horses and men with defensive armour, and employing, like the hoplites, long spears, for which reason this arm of the service is also called the spear-bearing and the lance-bearing cavalry, or even the shield-bearing cavalry, when it, sometimes, carries unusually long² shields for the purpose of protecting the mount as well as the rider. The branch which fights at long range is called both the archer-cavalry and the Scythian cavalry; and the intermediate variety, the skirmishers. These latter are posted on the flanks and do their fighting,

¹ That is, like the heavy-armed infantry.

² For *ἀσπίς* used of long shields, as here, compare Xenophon, *Anab.* i. 8. 9, who says that the Egyptian *γεμροφόροι* were equipped with *ποδῆρεσι ξυλίναῖς ἀσπίσιν* (cf. *ibid.* ii. 1. 6).

ASCLEPIODOTUS

νοῦντες οἱ μὲν τόξοις, οἱ δὲ ἀκοντίοις μάχονται, καὶ τῇ ἄλλῃ¹ χρώμενοι σκευῇ οἱ μὲν οὕτως, οἱ δὲ ἐκείνως· ὧν μὲν ἔνιοι² μετὰ τὴν ἀκόντισιν ἐγγύθεν μάχονται, οὓς ἰδίως ἐλαφροὺς ὀνομάζουσιν· ὅτ' ἂν δὲ πόρρωθεν ἀκοντίζωσι μόνον, Ταραντίνους.

- 4 Εἰσὶν οὖν αἱ πᾶσαι τῶν τάξεων διαφοραὶ αἶδε,³ ὧν ἐκάστη φάλαγξ προσαγορεύεται περιέχουσα συστήματα κατὰ ἀριθμὸν ἐπιτήδειον καὶ ἡγεμόνας αὐτῶν πρὸς τὸ ῥαδίως ποιεῖν τὰ παρακελευόμενα πρὸς τὴν ἐφήμερον γυμνασίαν τε καὶ ἄσκησιν τῆς πορείας καὶ στρατοπεδεύσεως καὶ παρατάξεως καὶ πρὸς τοὺς ἐπ' ἀληθείας ἀγῶνας.

II. Περὶ μερῶν τῆς φάλαγγος τῶν ὀπλιτῶν τῆς τε ὀνομασίας αὐτῶν καὶ τοῦ ἀριθμοῦ

Ἀναγκαῖον δὲ πρῶτον τὴν φάλαγγα καταλοχίσαι· τοῦτο δὲ ἐστὶ καταμερίσαι εἰς λόχους. ὁ δὲ λόχος ἐστὶν ἀριθμὸς ἀνδρῶν εἰς σύμμετρα διαιρῶν τὴν φάλαγγα· σύμμετρα δὲ ἐστὶ τὰ τιθέμενα μέρη, ἃ⁴ μηδὲν τὴν φάλαγγα πρὸς τὴν μάχην λυμαίνεται.⁵ δι' ὃ τὸν ἀριθμὸν τοῦ λόχου οἱ μὲν ὀκτώ, οἱ δὲ

¹ ἄλλῃ (and similarly τῇ and σκευῇ) F; αὐτῇ V (Leo Allatius) K. and R. ² ἐνιοι μὲν K. and R.

³ Added by K. and R.: θ D.

⁴ C (Salmasius): ἐστὶ θέμενα τὰ τιθέμενα τὰ μέρη μηδὲν F; ἐστὶ θέμενα τὰ μέρη ἃ μηδὲν V (Leo Allatius).

⁵ λυμαίνεται F.

¹ There seems to be no trace in actual practice of this threefold division in the cavalry. The author seems especially fond of such groupings by three, even to the point, one is inclined to suspect, of inventing some. Compare x. 15 and xi. This seems to be a trace of earlier rhetorical training.

² i.e., mutually interchangeable.

³ If the text be sound, and it will be noted that it depends

some with bows and some with javelins, the former using the general equipment of the light cavalry, the others that of the heavy cavalry. Of this intermediate variety some, who in a narrower sense are called the light cavalry, after hurling their javelins fight at close quarters, but when they merely hurl their javelins from a distance, they are called Tarentine cavalry.¹

These, then, are all the different military forces, each one of which is called a phalanx and includes divisions of a suitable size and officers sufficient in number to put orders into effect easily, both in daily exercises and in service upon the march, in camp, in battle formation, and in actual fighting.

II. *The Subdivisions of the Phalanx of Hoplites, their Names and their Strength*

It is necessary, first of all, to divide the phalanx, that is, to break it up into files. Now a file is a number of men dividing the phalanx into symmetrical² units, and by 'symmetrical' I mean those which do not interfere with the fighting efficiency of the phalanx.³ Accordingly some have formed the file of eight men, others of in part upon an emendation by Salmasius, the definition of a file is somewhat unsatisfactory. The file, the smallest unit of the phalanx, corresponds in formation to the file in modern armies, except that it was normally of eight to sixteen men, but in actual use to the squad, being the basic tactical unit. The second part of the sentence seems to suggest that any scheme of formation for purposes of marching or manœuvring is to be subordinated to the fighting efficiency of the phalanx as a unit.

Asclep. i. 4 = Ael. iii. 3.

Asclep. ii. 1 = Ael. iv. 1-3.

ASCLEPIODOTUS

δέκα, οἱ δὲ δυοκαίδεκα ἀνδρῶν πεποιήκασιν, ἕτεροι δὲ ἑξκαίδεκα πρὸς τὸ συμμέτρως ἔχειν τὴν φάλαγγα¹ εἰς τε τὸ διπλασιάσαι πρὸς² τὰς ῥηθισομένας χρείας ἐπὶ δύο καὶ τριάκοντα ἀνδρα καὶ εἰς τὸ συναιρεῖσθαι εἰς ἡμισυ ἐπ' ἀνδρα, ὀκτώ· οὐδὲν γὰρ ἔμποδον³ ἔσται τοῖς ὀπισθεν μαχομένοις ψιλοῖς ἀκοντίζουσιν ἢ σφενδονῶσιν ἢ καὶ τοξεύουσιν· ὑπερβήσονται γὰρ τὸ τῆς φάλαγγος βάθος.

2 Ἐκαλεῖτο δὲ ὁ λόχος πάλαι καὶ στίχος καὶ συνωμοτία⁴ καὶ δεκανία,⁵ καὶ ὁ μὲν ἄριστος καὶ ἡγεμῶν τοῦ στίχου λοχαγός, ὁ δὲ ἔσχατος οὐραγός· ὕστερον δὲ μεταταχθεὶς ὁ στίχος διαφόρους ἔσχεν τῶν μερῶν ἐπωνυμίας· τό τε γὰρ ἡμισυ ἡμιλόχιον ὠνόμασται⁶ καὶ διμοιρία, τὸ μὲν ὡς πρὸς τὸ τῶν δεκαεξ ἄνδρῶν πλῆθος, τὸ δὲ ὡς πρὸς τὸ τῶν δώδεκα, καὶ ὁ ἡγεμῶν ἡμιλοχίτης καὶ διμοιρίτης, καὶ τὸ τέταρτον ἐνωμοτία καὶ ἐνωμοτάρχης ὁ ἡγούμενος.

3 <Ὁ δὲ ἡγούμενος ὠνόμασται καὶ πρωτοστάτης>,⁷ ἐπιστάτης δὲ ὁ ἐπόμενος, ὥστε καθ' ὄλον⁸ τὸν στίχον εἶναι πρῶτον⁹ πρωτοστάτην,¹⁰ εἶτα ἐπιστά-

¹ K. and R. (after C?): τῆς φάλαγγος F.

² διπλασιάσαι K. and R.; πρὸς C (Salmasius): διπλάσια τὰς F; διπλασίονα (?) πρὸς C (Salmasius).

³ γὰρ ἐμποδον F; δὲ ἐμποδον K. and R.

⁴ AC (Salmasius): συνωμετια FB (o in marg.): συνωμοτία V (Leo Allatius): ἐνωμοτία K. and R.

⁵ δεκανια F.

⁶ ὠνόμαστο K. and R.

⁷ Supplied by K. and R. to fill the evident lacuna.

⁸ K. and R. (note): καθόλου F.

⁹ Added by K. and R. (note).

¹⁰ πρωτοστατῶν K. and R. (text).

TACTICS, II. 1 - 3

ten, others of twelve, and yet others of sixteen men, so that the phalanx will be symmetrical both for doubling the depth of its units, in circumstances to be described later, so that it may consist of thirty-two men, and also for reducing it by one-half, *i.e.*, to eight men; for thus it will not interfere with the light infantry who fight in the rear, since, as they use javelins, slings, or also bows, they will be able to shoot their missiles over a phalanx of this depth.¹

Now the file was formerly called a row, a synomoty, and a decury, and the best man and the leader of the row was called the file-leader (*lochagos*), while the last man was called the file-closer (*ouragos*). But when later on the row was reorganized its parts received different names; for the half is now called the half-file (*hemilochion*), or the double quarter (*dimoiria*), the former term being used for a file of sixteen men, the latter for one of twelve, and the leader is now called the half-file-leader (*hemilochites*) and the double-quarter-leader (*dimoirites*), and the quarter is called an enomoty and its leader an enomotarch.

[The leading man has been given the name of the front-rank-man (*protostates*)], while the one who follows him is called the rear-rank-man (*epistates*), so that in the whole file there comes first a front-rank-man, then a rear-rank-man, then successively

¹ In the classical period down to the innovations of Epaminondas the battle-line of the Greeks was usually eight men deep, the Lacedaemonians only extending this at times to twelve men. Our author's ideal for the depth of the perfect phalanx is sixteen men.

ASCLEPIODOTUS

την,¹ εἰθ' ἐξῆς πρωτοστάτην, εἶτα ἐπιστάτην, καὶ τοῦτο παρ' ἓνα μέχρις οὐραγοῦ, καθ' ἃ ὑπογέγραπται·

πρωτοστάτης λοχαγός	παραστάται
ἐπιστάτης	παραστάται
πρωτοστάτης	παραστάται
ἐπιστάτης	παραστάται
πρωτοστάτης ³	παραστάται
ἐπιστάτης οὐραγός	παραστάται

4 "Ὅτ' ἂν δὲ λόχῳ λόχος παρατεθῆ, ὥστε λοχαγὸν λοχαγῶ καὶ οὐραγὸν οὐραγῶ καὶ τοὺς μεταξὺ τοῖς ὁμοζύγοις παρίστασθαι, συλλοχισμὸς ἔσται τὸ τοιοῦτον, οἱ δὲ ὁμόζυγοι³ τῶν λόχων πρωτοστάται ἢ ἐπιστάται διὰ τὸ παραλλήλους⁴ ἴστασθαι παραστάται κεκλήσονται.

5 Ὁ δὲ ἐκ πάντων συλλοχισμὸς φάλαγξ, ἧς⁵ τὸ τῶν λοχαγῶν⁶ τάγμα μέτωπον καὶ μῆκος καὶ πρόσωπον καὶ στόμα καὶ παράταξις καὶ πρωτολοχία καλεῖται καὶ πρῶτον ζυγόν· ὁ δὲ κατόπιν κείμενος μετὰ⁷ τοῦτον στίχος τῶν ἐπιστατῶν κατὰ μῆκος τῆς φάλαγγος δεύτερον ζυγόν, καὶ ὁ τούτῳ παράλληλος ὑπ' αὐτὸν τρίτον, καὶ τέταρτόν ἐστι⁸ τὸ ὑπὸ τοῦτον⁹ ζυγόν καὶ πέμπτον ὡς αὐτῶς¹⁰ καὶ ἕκτον καὶ ἐξῆς μέχρις οὐραγοῦ· κοινῶς δὲ πᾶν τὸ μετὰ τὸ μέτωπον τῆς φάλαγγος βάθος ἐπονομάζεται καὶ ὁ ἀπὸ λοχαγοῦ ἐπ' οὐραγὸν στίχος κατὰ βάθος.

¹ ἐπιστατῶν K. and R. (text).

² πρωτοστατης F.

³ *Lex. mil.* 8, quoting this passage. K. and R.: δεσμοζευγοι F.

⁴ παρ' ἀλλήλοις *Lex. mil.* K. and R.

⁵ καὶ K. and R.

⁶ K. and R.: λόχων F.

⁷ K. and R. (F?): παρὰ ABCV.

⁸ εἰ τι B: εἰσι A: εἴη V.

⁹ τοῦ τὸν F.

¹⁰ αὐτῶς F.

TACTICS, II. 3 - 5

a front-rank-man and a rear-rank-man, and so on, one after the other, until one reaches the file-closer, according to the following diagram :

Front-rank-man (= file-leader)	comrades-in-rank
Rear-rank-man	comrades-in-rank
Front-rank-man	comrades-in-rank
Rear-rank-man	comrades-in-rank
Front-rank-man	comrades-in-rank
Rear-rank-man (= file-closer)	comrades-in-rank

Now when one file is placed beside another, so that file-leader stands beside file-leader, file-closer beside file-closer, and the men in between beside their comrades-in-rank, such an arrangement will be a formation by file (*syllochismos*), and the men of the files forming the same rank, front-rank-men, and rear-rank-men, will be called comrades-in-rank because they stand side by side.

The assembly (*syllochismos*) of all the files constitutes a phalanx, in which the rank of the file-leaders is called the front (*metopon*), the length (*mekos*), the face (*prosopon*), the mouth (*stoma*), the marshalling (*parataxis*), the head of the files (*protolochia*), and the first line (*proton zygon*); and the rank behind this consisting of rear-rank-men running the length of the phalanx, is the second line, and the rank parallel and behind this the third line, and the line behind this is the fourth, and similarly the fifth and the sixth and so on down to the file-closer; but taken all together everything behind the front of the phalanx is called its depth, and the file, from file-leader to file-closer, is the file in depth.

Asclep. ii. 4 = Ael. vi.

Asclep. ii. 5 = Ael. vii. 1-3.

TACTICS, II. 6 - 7

○ ○ ○ ○ ○ ○ ○ ○ ○ ○ ○ ○ ○ rank
 ○ ○ ○ ○ ○ ○ ○ ○ ○ ○ ○ ○ ○ rank
 ○ ○ ○ ○ ○ ○ ○ ○ ○ ○ ○ ○ ○ rank
 ○ ○ ○ ○ ○ ○ ○ ○ ○ ○ ○ ○ ○ last rank

And those who stand behind one another in this formation are said to form a file (*stoichein*), but those who stand side by side are said to form a rank (*zygein*). When the phalanx is bisected by a line running from front to rear, one half is called the right wing and the other the left wing, while the point of division is called the navel and the joint.

How great the strength of the phalanx ought to be is not easy to determine, for the strength must be determined in proportion to the number which each commander is able to equip; only the strength must in every instance be suitable to the changes in form of the detachments, I mean the decrease and increase of their depth. Accordingly you should rather select numbers which are evenly divisible by two down to unity,¹ and you will find that most tacticians have made the phalanx to consist of 16,384 hoplites, because this number is divisible by two down to unity, and half that number (*i.e.*, 8192) for the phalanx of the light infantry.² So let us also assume that the phalanx will consist of this number of men, and the file of sixteen men.

² The number 16,384 represents, of course, only an ideal for tactical convenience and exactness in manœuvres. As an ideal or standard theoretical number it does no harm, since no one would dream of allowing it to interfere with practical considerations.

Asclep. ii. 6 = Ael. xxvi. 1-2; vii. 3. Asclep. ii. 7 = Ael. viii.

ASCLEPIODOTUS

- 8 Ἔσονται δὴ οἱ μὲν δύο λόχοι διλοχία καὶ ὁ ἐπ' αὐτοῖς ἄρχων διλοχίτης, οἱ δὲ τούτων διπλάσιοι τετραρχία καὶ ὁ ἐπ' αὐτοῖς τετράρχης, οἱ δὲ ἔτι τούτων διπλάσιοι τάξις καὶ ὁ ἡγεμὼν ταξίαρχος μὲν πάλαι, νῦν δὲ καὶ ἑκατοντάρχης, οἱ δὲ τῆς τάξεως διπλάσιοι σύνταγμα καὶ ὁ ἐπὶ τούτοις συνταγματάρχης.
- 9 Τοὺς δὲ ἐκτάτους² τὸ μὲν παλαιὸν ἡ τάξις εἶχεν, ὡς καὶ τὸ ὄνομα σημαίνει, δι' ὅτι τῆς τάξεως ἐξάριθμοι³ ὑπήρχον, στρατοκήρυκα, σημειοφόρον,⁴ σάλπιγκτήν, ὑπηρέτην, οὐραγόν· τὸν μὲν, ὅπως τῇ φωνῇ σημαίνει τὸ προσταττόμενον, τὸν δὲ σημείω, εἰ⁵ μὴ φωνῆς κατακούειν ἐνδέχοιτο διὰ θόρυβον, τὸν δὲ τῇ σάλπιγγι, ὅποτε μὴδὲ σημείον⁶ βλέποιν διὰ κονιορτόν, καὶ τὸν ὑπηρέτην, ὥστε τι παρακομίσαι τῶν εἰς τὴν χρείαν, τὸν γὰρ μὴν ἕκτακτον οὐραγόν πρὸς τὸ ἐπανάγειν τὸν ἀπολειπόμενον ἐν⁸ τῇ τάξει. ὀκτὼ γὰρ ἀνδρῶν ὄντος τοῦ λόχου ὀκταλοχία τὸ τετράγωνον ἐποίει σχῆμα, ὅπερ διὰ τὴν πανταχόθεν ἰσότητα μόνον τῶν μερῶν τῆς φάλαγγος ὁμοίως κατακούειν τῶν προσταττομένων δυνάμενον εὐλόγως τάξις ἐπωνό-

¹ K. and R. : ἐπὶ F.

² C (Salmasius), *Lex. mil.* § 14, K. and R. : ἐκτάτους F.

³ K. and R. : ἐξ ἀριθμοί F : ἐξ ἀριθμῶ [sic] C (Salmasius) : ἐνάριθμοι V (Leo Allatius).

⁴ σάλπιγκτην. ἡμάφορον F : σημειοφόρον K. and R. I have changed the order of these words to correspond with the sequence in which they are defined below ; it is also the order in the *Lex. mil.* § 14.

⁵ C (Salmasius), *Lex. mil.* § 14, K. and R. : δ' ὀσῶι εἰ F.

⁶ C (Salmasius), *Lex. mil.* § 14, K. and R. : ὅποτε δ' εἰρη δ' εἰρημε. ἢν F.

⁷ *Lex. mil.* § 14, K. and R. : τότε F.

⁸ ἐπὶ K. and R. : ἐπὶ τὴν τάξιν *Lex. mil.* § 14.

TACTICS, II. 8 - 9

Now two files will form a double-file (*dilochia*) and the officer in command will be a double-file-leader (*dilochites*), and twice this number will be a platoon (*tetrarchia*), and the officer in command a platoon-commander (*tetrarches*), and twice this latter number will be a company (*taxis*), and the officer in command a company-commander (*taxiarchos*), as he used to be called, but nowadays also a captain-of-a-hundred (*hekatontarches*), and twice the number of a company will be a battalion (*syntagma*), and the officer in command a battalion-commander (*syntagmatarches*).¹

The supernumeraries were formerly attached to the company, as their name (*ektaktoi*)² indicates, because they were not included in the number of the company: an army-herald, a signalman, a bugler, an aide, and a file-closer. The first was to pass on the command by a spoken order, the second by a signal, in case the order could not be heard because of the uproar, the third by the bugle, whenever the signal could not be seen for the dust; the aide was there to fetch whatever was needed, while the supernumerary file-closer was to bring up the straggler to his position in the company. For when the file consisted of eight men, eight files constituted the square, which, alone of all the detachments, by reason of the equal length of the sides of the formation could hear equally well the commands from every quarter and so was properly

¹ The file has thus 16, the double-file 32, the half-company 64, the company 128, and the battalion 256.

² That is, 'a body of men outside the company' (*taxis*).

ASCLEPIODOTUS

μαστο· διπλασιασθέντος δ' ὕστερον τοῦ λόχου ἡ συνταξιαρχία¹ τὸ τετράγωνον ἀπετέλεσεν, δι' α̅² εἰς ταύτην μετῆλθον οἱ ἕκτακτοι.³

- 10 Τὸ διπλάσιον δὲ τοῦ συντάγματος πεντακοσιαρ-
 χίαν καὶ τὸν ἐπὶ τούτῳ πεντακοσιάρχην ὠνόμασαν,
 τὸ δὲ τούτου διπλάσιον χιλιαρχίαν καὶ τὸν ἡγεμόνα
 χιλιάρχην, τὰς δὲ δύο χιλιαρχίας πάλαι μὲν κέρας
 καὶ τέλος καὶ τελάρχην τὸν ἡγούμενον, ὕστερον
 δὲ μεραρχίαν καὶ μεράρχην· δι' ὃ καὶ τὸ τούτου
 διπλάσιον φαλαγγαρχία καὶ νῦν ἔτι καλεῖται, πλήν
 καὶ ἀποτομὴ κέρατος, καὶ ὁ ἡγεμὼν πάλαι μὲν
 στρατηγός, νῦν δὲ φαλαγγάρχης· τὸ δὲ τῆς
 φαλαγγαρχίας⁴ ἦτοι ἀποτομῆς διπλοῦν διφαλαγγία
 καὶ κέρας καὶ ὁ ἐπ' αὐτῇ κεράρχης, αὐτὸ δὲ τὸ ἐκ
 τῶν δυεῖν κεράτων ἡ φάλαγξ, ἐφ' ἣ ὁ στρατηγός,
 κέρατα ἔχουσα δύο, φαλαγγαρχίας ἦτοι ἀποτομὰς
 δ̅, μεραρχίας⁵ ἦ, χιλιαρχίας ἰ̅,⁶ πεντακοσιαρχίας
 λ̅β̅, συνταξιαρχίας ξ̅δ̅, ταξιαρχίας ρ̅κ̅ῆ, τετραρχίας
 σ̅ν̅ζ̅,⁷ διλοχίας φ̅ι̅β̅,⁸ λόχους α̅κ̅δ̅.

¹ K. and R. : συνταξία F (cf. § 10).

² δι' δ̅ K. and R.

³ C (Salmasius), K. and R. : ἕκτατοι F.

⁴ *Lex. mil.* § 18, K. and R. : φάλαγγος F.

⁵ K. and R. (after B and C ?) : δ̅μεραρχίας F.

⁶ BC (Salmasius), K. and R. : κ̅ F.

⁷ ζ̅ν̅ζ̅ (sic) K. and R.

⁸ ABC (Salmasius) V (Leo Allatius), K. and R. : φ̅ι̅ε̅ F
 (but φ̅ι̅β̅ below).

¹ Or 'command,' to preserve in the translation the suggested etymological connexion between τῶν προστατομένων and τάξις.

TACTICS, II. 9 - 10

called a company;¹ when, however, the file was later doubled, the battalion (*syntaxiarchia*) constituted the square, and, as a consequence, included the supernumeraries.²

Two battalions are called a regiment (*pentakosi-archia*), and its commander a colonel (*pentakosiarches*), and two regiments a brigade (*chiliarchia*), and its commander a brigadier-general (*chiliarches*), and two brigades were formerly called a wing and a complement (*telos*), and its leader a complement-commander (*telarches*), but later it was called a division (*merarchia*), and its leader a division-commander (*merarches*); two divisions, consequently, are even yet called a corps (*phalangarchia*), as well as a half-wing (*apotome keratos*), and its commander, formerly a general, is now a corps-commander (*phalangarches*); when the corps or half-wing is doubled it is a double-corps (*diphalangia*) and wing (*keras*), and its commander a wing-commander (*kerarches*); and, finally, the union of the two wings is called the army (*phalanx*), under the command of the general, comprising 2 wings, 4 corps or half-wings, 8 divisions, 16 brigades, 32 regiments, 64 battalions, 128 companies, 256 platoons, 512 double-files, and 1024 files.

² The battalion is the real unit of the phalanx, a perfect square of 16 ranks and 16 files. As a square it became the tactical unit for all the quarter-turns, etc., of the phalanx, pivoting on the men at the four corners, and so is the smallest unit to have its own officers outside the ranks. It was known under several names, in Asclepiodotus as *syntagma* and *syntaxiarchia* (ii. 9), in the Anonymus Byzantinus as *tagma*.

Asclep. ii. 10 = Ael. ix. 5-10.

ASCLEPIODOTUS

β ¹ κέρασ δ ἀποτομή η̄ μεραρχία ῑς ² χιλιαρχία λβ ³ πεντακοσιαρχία	ξδ ⁴ συνταξιαρχία ρκῆ τάξις σνς ⁵ τετραχία φιβ ⁶ διλοχία ακδ ⁷ λόχος
--	--

III. Περὶ διατάξεως τῶν ἀνδρῶν καθ' ὅλην τε τὴν φάλαγγα ἢ² κατὰ τὰ³ μέρη

Διατέτακται δὲ ἡ τε ὅλη φάλαγξ καὶ τὰ μέρη κατὰ τετράδα, ὥστε τῶν τεσσάρων ἀποτομῶν τὴν μὲν ἀρίστην κατ' ἀρετὴν τοῦ δεξιοῦ κέρατος τετάχθαι δεξιάν, τὴν δὲ δευτέραν ἀριστερὰν τοῦ λαιοῦ καὶ δεξιάν τὴν τρίτην, τὴν δὲ τετάρτην τοῦ δεξιοῦ λαιάν. οὕτω γὰρ⁴ διατεταγμένων ἴσον⁵ εἶναι συμβήσεται κατὰ δύναμιν τὸ δεξιὸν κέρασ τῷ λαιῷ· τὸ γὰρ ὑπὸ πρώτου⁶ καὶ τετάρτου, φασὶ γεωμέτριοι,⁷ ἴσον ἔσται τῷ ὑπὸ δευτέρου καὶ τρίτου, εἰὰ τὰ⁸ τέσσαρα ἀνὰ λόγον⁹ ἦ.

Τὸν αὐτὸν δὲ τρόπον καὶ ἐκάστην ἀποτομὴν ἦτοι φαλαγγαρχίαν διακοσμήσομεν· ἐπεὶ¹⁰ γὰρ ἡμισυ μὲν αὐτῆς ἔστιν ἡ μεραρχία, τέταρτον δὲ ἡ χιλιαρχία· τὴν μὲν ἀρίστην χιλιαρχίαν τῆς δεξιᾶς

¹ ζ F.

² καὶ K. and R.

³ Om. AC (Salmasius), K. and R.

⁴ δὲ C (Salmasius).

⁵ K. and R. : ἴσην F.

⁶ ABC (Salmasius), K. and R. : πρῶτον F.

⁷ γεωμέτροι K. and R. If it is necessary to emend I should prefer γεωμετρικοί or γεωμέτραι.

⁸ Added by Oldfather.

⁹ ἀνάλογα C (Salmasius), K. and R.

¹⁰ καὶ K. and R. in the text, but it would seem from the note that ἐπεὶ was intended : ἐπὶ C (Salmasius).

TACTICS, II 9 – III. 2

2 wings	64 battalions ¹
4 half-wings	128 companies (<i>taxis</i>) ²
8 divisions	256 platoons
16 brigades	512 double-files
32 regiments	1024 files.

III. *The Disposition of the Men both in the entire Army and in its Subdivisions*

The entire army as well as its units is disposed on the basis of a fourfold division, so that of the four half-wings the bravest holds the right of the right wing, the second and third in point of valour the left and right, respectively, of the left wing, and the fourth the left of the right wing. For with the units ordered in this manner the right wing will have the same strength as the left, since, as the geometers say, the product of the first and the fourth will equal that of the second and third, if the four be proportionate.³

In the same way we shall arrange each half-wing or corps; since, indeed, a half of it is the division and a fourth the brigade; we shall station the bravest brigade on the right of the right-hand corps, the

¹ Called a *syntagma* in ii. 8.

² Just above this unit has been called a *taxiarchia*.

³ There is some point to this arrangement, if one thinks of an arithmetical series, where, *e.g.*, in the series 5, 7, 9, 11, $5 + 11 = 7 + 9$; but the words clearly refer to a geometrical series 2, 4, 8, 16, or a proportion $2 : 4 :: 8 : 16$, where $2 \times 16 = 4 \times 8$, although it is difficult to see how one multiplies strength by merely adding together units.

With Asclep. iii. 1-3 *cf.* Ael. x.

ASCLEPIODOTUS

μεραρχίας τάξομεν δεξιάν, τὴν δὲ δευτέραν κατ' ἀρετὴν τῆς λαιᾶς ἀριστεράν, δεξιάν δὲ τὴν¹ τρίτην, τὴν δὲ ὑπολειπομένην λαιάν² τῆς δεξιᾶς. οὕτω γὰρ ἰσοσθενήσουσι καὶ αἱ μεραρχίαι.

3 Καὶ τὰς χιλιαρχίας δὲ ὡς αὐτῶς διαθήσομεν. καὶ γὰρ τούτων ἡμισυ μὲν ἔστιν ἡ πεντακοσι-αρχία, τέταρτον δὲ ἡ συνταξιαρχία· οὐκοῦν τὴν μὲν πρώτην καὶ τετάρτην συνταξιαρχίαν τῇ δεξιᾷ πεντακοσιαρχία νεμοῦμεν τὴν πρώτην ἐν τοῖς δεξιοῖς αὐτῆς μέρισι τιθέντες, δευτέραν δὲ καὶ τρίτην συνταξιαρχίαν τῇ λαιᾷ πεντακοσι-αρχία προσνεμοῦμεν κατὰ τὸ ἴσον μέρος αὐτῆς τιθέντες.

4 Τὴν δὲ πάλιν³ συνταξιαρχίαν ἐκάστην ἡμισυ μὲν ἔχουσαν τὴν ταξιαρχίαν, τέταρτον δὲ τὴν τετραρχίαν κατὰ τὸν αὐτὸν λόγον διαθήσομεν, ὥστε τὰς ἐν αὐτῇ ταξιαρχίας ἰσοσθενεῖν. τὸ δ' ὁμοιον γέγονεν καὶ⁴ ἐπὶ τῆς τετραρχίας⁵ καὶ γὰρ ταύτης ἡμισυ μὲν ἡ διλοχία,⁶ τέταρτον δὲ ὁ λόχος.

5 Τὸν μέντοι γε λόχον οὐ κατὰ ταῦτα⁷ διατάξομεν, ἀλλὰ τοὺς μὲν πρόσω τῶν ἀνδρῶν κατὰ τὴν ῥώμην, τοὺς δ' ὀπίσω κατὰ τὴν φρόνησιν διαφέροντας, αὐτῶν δὲ τῶν πρόσω τοὺς λοχαγοὺς μεγέθει τε καὶ ῥώμῃ καὶ ἐμπειρία προὔχοντας⁸ τῶν ἄλλων· τοῦτο γὰρ τὸ ζυγὸν συνέχει τὴν φάλαγγα καὶ

¹ C (Salmasius), K. and R. : δεξιάν· τὴν δὲ F.

² K. and R. : λαιαν F.

³ K. and R. : δευτέραν πάλιν F.

⁴ K. and R. : τῷ καὶ F.

⁵ τετραρχίας F.

⁶ διχολοχία F.

⁷ K. and R. : αὐτὰ F.

⁸ προύχοντ(ας) F.

second and third in point of valour on the left and right of the left-hand corps, and the remaining brigade on the left of the right-hand corps ; for thus the several corps will have a uniform strength.

The brigades also we shall order in the same manner, since a half of these is the regiment, and a fourth the battalion. We shall, then, assign the first and fourth battalion to the right-hand regiment, setting the first among its right-hand units, and we shall, further, assign the second and third battalion to the left-hand regiment, disposing them in the regiment on exactly the same principle.

Each battalion also, since it has as its half the company and as its quarter the platoon, will be ordered in like manner, that its companies may have an equal strength. The same arrangement applies also to the platoon. For its half is the double-file, and its quarter the file.¹

We shall not, however, arrange the file as above, but we shall place the strongest in the front rank and behind them the most intelligent, and of the former the file-leaders shall be those who excel in size, strength, and skill ; because this line of file-leaders binds the phalanx together and is like the

¹ Aelian, in the parallel account, follows our author, but arranges the divisions of the army on the basis of the strength of the commanders and not of the men. This is worse than the arrangement proposed by Asclepiodotus, for in practical operations we know of such a distribution of strength only in the largest divisions of the army. It remained for the philosophers to seize upon an arrangement applicable only to large masses and apply it down to the very lowest unit, the file, and, as in Aelian, even down to the individual officers !

With Asclep. iii. 4 *cf.* Ael. x. Asclep. iii. 5 = Ael. xiii. 1-2.

ASCLEPIODOTUS

οιον τῆς μαχαίρας ἐστὶ τὸ στόμα, ὅθεν καὶ ἀμφιστόμους καλοῦσι τὰς ἀμφοτέρωθεν¹ λοχαγοῖς συνηχομένας τάξεις.

- 6 Δεῖ δὲ καὶ τὸ δεύτερον ζυγὸν μὴ πάνυ χεῖρον εἶναι, ἵνα πεσόντος τοῦ λοχαγοῦ ὁ παρεδρεύων προελθὼν εἰς τὸ πρόσω συνέχη τὴν φάλαγγα. οἱ δὲ οὐραγοὶ οἱ τ' ἐν τοῖς λόχοις καὶ οἱ ἑκτακοί² συνέσει τῶν ἄλλων διαφερέτωσαν, οἱ μὲν, ἵνα τοὺς ἰδίους κατευθύνωσι λόχους, οἱ δ' ὅπως στοιχῶσί τε τὰ συντάγματα καὶ ζυγῶσιν ἀλλήλοις τοὺς τε λειποτακτοῦντας³ διὰ δειλίαν εἰς τάξιν ἐπανάγοιεν καὶ ἐν τοῖς συνασπισμοῖς συνεδρεύειν⁴ ἀναγκάζοιεν.

IV. Περὶ διαστημάτων

Τοῦτον δὴ τὸν τρόπον ἐξομοιωθέντων τῷ ὄλω τῶν μορίων ἐξῆς ἂν εἶη ῥητέον περὶ διαστημάτων⁵ κατὰ τε μῆκος καὶ βάθος· τριττὰ γὰρ ἐξηγήρηται⁶ πρὸς τὰς τῶν πολεμίων⁷ χρείας, τό τε ἀραιότατον, καθ' ὃ ἀλλήλων ἀπέχουσι κατὰ τε μῆκος καὶ βάθος ἕκαστοι πῆχεις τέσσαρας, καὶ τὸ πυκνότατον, καθ' ὃ συνησπικῶς ἕκαστος ἀπὸ τῶν ἄλλων πανταχόθεν διέστηκεν πηχυαῖον διάστημα, τό τε

¹ K. and R.: ἀμφοτέροθεν F.

² C (Salmasius) D, K. and R.: ἑκτατοὶ F.

³ λειποτακτοῦντας C (Salmasius).

⁴ συνερείδειν K. and R. perhaps rightly; cf. Polyb. xii. 21. 3.

⁵ A (2nd hand), K. and R.: περιδιασθηκασί F.

⁶ ἐξεύρηται C (Salmasius) E.

⁷ πολεμικῶν K. and R.

TACTICS, III. 5 – IV. 1

cutting edge of the sword, for which reason the companies, when covered on both flanks by file-leaders, are called double-edged (*amphistomoi*).

The second line must also be not much inferior to the first, so that when a file-leader falls his comrade behind may move forward and hold the line together; and the file-closers, both those in the files and those attached to larger units, should be men who surpass the rest in presence of mind, the former to hold their own files straight, the latter to keep the battalions in file and rank with one another, besides bringing back to position any who may leave their places through fear, and forcing them to close up in case they lock shields.¹

IV. *Intervals*

Now that the parts of the army have been brought into due relation with the entire force, we may well speak of the intervals in both length and depth. The needs of warfare have brought forth three systems of intervals: the most open order, in which the men are spaced both in length and depth four cubits apart,² the most compact, in which with locked shields each man is a cubit distant on all sides from his comrades, and the intermediate, also

¹ The importance of the ranks of file-leaders and file-closers can scarcely be exaggerated; the former were the first to meet the enemy and in between them and the file-closers were included the less brave.

² The cubit may be taken as approximately eighteen inches.

Asclep. iii. 6 = Ael. xiii. 3, 5; xi. 3.

Asclep. iv. 1 = Ael. xi. 1-4.

ASCLEPIODOTUS

μέσον, ὃ καὶ πύκνωσιν ἐπονομάζουσιν, ᾧ διεστήκασιν πανταχόθεν δύο πήχεις ἀπ' ἀλλήλων.

2 Γίνεται δὲ μεταβολὴ κατὰ τὰς χρείας ἕκ τινος τούτων εἰς τι τῶν λοιπῶν, καὶ ἤτοι κατὰ μῆκος μόνον, ὃ καὶ ζυγεῖν ἔφαμεν λέγεσθαι, ἢ κατὰ βάθος, τὸ καὶ στοιχεῖν,¹ ἢ κατ' ἄμφω, ὅπερ ὀνομάζεται κατὰ παραστάτην καὶ ἐπιστάτην.²

3 Δοκεῖ δὲ τὸ τετράπηχυ κατὰ φύσιν εἶναι, ὅθεν οὐδὲ κεῖται ἐπ' αὐτῷ ὄνομα· ἀναγκαῖον δὲ τὸ δίπηχυ³ καὶ ἔτι⁴ μᾶλλον τὸ πηχυαῖον. τούτων δὲ τὸ μὲν δίπηχυ κατὰ πύκνωσιν, ἔφη, ἐπωνόμασται, τὸ δὲ πηχυαῖον κατὰ⁵ συνασπισμόν. γίνεται δὲ ἢ μὲν πύκνωσις, ὅτ' ἂν ἡμεῖς τοῖς πολεμίοις τὴν φάλαγγα ἐπάγωμεν,⁶ ὃ δὲ συνασπισμός, ὅτ' ἂν οἱ πολέμοι ἡμῖν ἐπάγωνται.

4 Ἐπεὶ οὖν χίλιοι εἴκοσι τέσσαρες εἰσιν οἱ κατὰ μέτωπον τῆς φάλαγγος ἀφωρισμένοι λοχαγοί, δῆλον ὅτι τεταγμένοι μὲν ἐφέξουσιν πήχεις ἕξ καὶ ἐνενήκοντα καὶ τετρακισχιλίους, ὅπερ ἐστὶ στάδια δέκα καὶ πήχεις ἐνενήκοντα ἕξ, πεπυκνωκότες δὲ σταδίου πέντε καὶ πήχεις μῆ,⁷ συνησπικότες δὲ σταδίου δύο καὶ ἥμισυ καὶ

¹ Oldfather: τὲ καὶ στοιχεῖον F. ὅπερ καὶ στοιχεῖν was suggested by K. and R.; possibly ὃ καὶ should be read.

² C (Salmasius), K. and R.: καὶ παραστάτην ἐπιστάτην F. Perhaps one should read καὶ παραστατεῖν καὶ ἐπιστατεῖν.

³ B (margin) C (Salmasius) E, K. and R.: ο πηχυ F.

⁴ K. and R.: ἔστι F.

⁵ B (margin) DE, K. and R.: κα F.

⁶ B (margin) E, K. and R.: ἐπωμεν F.

⁷ B (margin) C (Salmasius) DE, K. and R.: πήχει· μῆ F.

¹ It must be borne in mind that one soldier is included in the interval, i.e., the distance is from right shoulder to

TACTICS, iv. 1 - 4

called a 'compact formation,' in which they are distant two cubits from one another on all sides.¹

As occasion demands a change is made from one of these intervals to one of the others, and this, either in length only, which, as we have noted before, is called forming by rank,² or in depth, *i.e.*, forming by file, or in both rank and file, which last is called 'by comrade-in-rank' and 'by rear-rank-man.'

The interval of four cubits seems to be the natural one and has, therefore, no special name; the one of two cubits and especially that of one cubit are forced formations. I have stated³ that of these two spacings the one of two cubits is called 'compact spacing' and the one of a single cubit 'with locked shields.' The former is used when we are marching the phalanx upon the enemy, the latter when the enemy is marching upon us.

Now since the file-leaders, forming the front of the phalanx, number 1024, it is clear that, drawn up in the most open formation,⁴ they will cover 4096 cubits, which is 10 stades and 96 cubits; in the compact formation, 5 stades and 48 cubits; and with locked shields $2\frac{1}{2}$ stades and 24 cubits.⁵

right shoulder or from breast to breast. The interval of one cubit seems hardly enough, but it was used only in receiving a charge (*cf.* § 3 below) and is the interval of the Swiss pikemen of the fifteenth and sixteenth centuries (*cf.* R. Schneider, *Legion und Phalanx*, 70).

¹ The reference is to ii. 6.

² *Cf.* § 1, above.

⁴ *Τάττω* ('draw up') is used here without qualifying phrase, since the formation has no special name (*cf.* § 3 above).

⁵ That is, the phalanx of 16,384, drawn up 16 deep, would occupy 2048 yards, 1024 yards, and 512 yards respectively.

Asclep. iv. 2 = Ael. xi. 1-4. Asclep. iv. 3 = Ael. xi. 5.

Asclep. iv. 4 = Ael. xi. 6.

ASCLEPIODOTUS

πήχεις εἴκοσι τέσσαρας, πρὸς ὃ σε¹ δεήσει καὶ τῶν χωρίων τὰς ἐκλογὰς ποιεῖσθαι.

V. Περὶ ὄπλων ἰδέας² τε καὶ συμμετρίας

Τῶν δὲ φάλαγγος ἀσπίδων ἀρίστη ἢ Μακεδονικὴ χαλκῇ ὀκτωπάλαιστος, οὐ λίαν κοίλη· δόρυ δὲ αὐτὸ οὐκ ἔλαττον δεκαπήχεος, ὥστε τὸ προπίπτον αὐτοῦ εἶναι οὐκ ἔλαττον ἢ ὀκτάπηχου, οὐ μὴν οὐδὲ μείζον ἐτέλεσαν δύο³ καὶ δέκα πήχων,⁴ ὥστε τὴν πρόπτωσιν εἶναι δεκάπηχυν, ᾧ δὴ καὶ⁵ ἢ Μακεδονικὴ φάλαγξ χρωμένη ἐν καταπύκνω στάσει ἀνύποιστος εἶναι ἐδόκει⁶ τοῖς πολεμίοις. εὐδηλον γάρ, ὅτι τῶν μέχρι τοῦ πέμπτου⁷ ζυγοῦ τὰ δόρατα προπίπτει τοῦ μετώπου· οἱ μὲν γὰρ ἐν τῷ δευτέρῳ ζυγῷ πήχεσι δυσὶν ὑποβεβηκότες ὀκτὼ πήχων⁸ τὴν τοῦ μετώπου ποιοῦνται πρόπτωσιν, ἐξ δὲ οἱ ἐν τῷ τρίτῳ ζυγῷ, οἱ δ' ἐν τῷ τετάρτῳ τεσσάρων, δύο δὲ οἱ ἐν τῷ πέμπτῳ, προβεβλημένοι⁹ δὲ τοῦ πρώτου ζυγοῦ πέντε σά-
 2 ρισσαι. καὶ Μακεδόνες μὲν¹⁰ οὕτω τῷ στοίχῳ,¹¹ φασί, τῶν δοράτων οὐ μόνον τῇ ὄψει τοὺς πολεμίους ἐκπλήττουσιν, ἀλλὰ καὶ τῶν λοχαγῶν ἕκαστον

¹ K. and R. (note): οὐσ F.

² D: εἰδέας F.

³ K. and R.: μεὶ ζολατεσ σαν καὶ F: μείζονα θέσαν καὶ C (Salmasius).

⁴ πήχεων F. In a strict Atticist one should, of course, accent πήχεων, but F (below, note 8) testifies apparently to πήχων (πήχαιων), and perhaps K. and R. are right in accenting the word thus. ⁵ Om. C (Salmasius).

⁶ Added by C (Salmasius) in the margin.

⁷ K. and R.: μέχρι πέμπτου F (πέμπτου DE).

⁸ πήχαιων F.

⁹ K. and R.: προβεβλημένοι F.

¹⁰ K. and R.: πεντε τεσσαρεσ· καὶ βαβυλώνιοι γὰρ οὕτω F:

TACTICS, IV. 4 - V. 2

It will be necessary, therefore, for you to select your terrain with all this in mind.

V. *The Character and appropriate Size of Arms*

The best shield for use in the phalanx is the Macedonian, of bronze, eight palms¹ in diameter, and not too concave; and their spear, moreover, is not shorter than ten cubits, so that the part which projects in front of the rank is to be no less than eight cubits—in no case, however, is it longer than twelve cubits, so as to project ten cubits. Now when the Macedonian phalanx used such a spear in a compact formation it appeared to the enemy irresistible. For it is obvious that the spears of the first five ranks project beyond the front, since the soldiers in the second rank, being two cubits back, extend their spears eight cubits beyond the front, those in the third rank six cubits, those in the fourth rank four cubits, those in the fifth rank two cubits, and so five spears extend beyond the first rank. And the Macedonians, men say, with this line of spears do not merely terrify the enemy by their appearance, but also embolden every file-leader,

¹ The 'palm' may be considered as approximately three inches.

Asclep. v. 1-2 = Ael. xii.; xiv.

πέντε τέσσαρες. και βαβυλώνιοι γὰρ προβεβλημένα δὲ τοῦ πρώτου ζυγοῦ πέντε σαρίσσα και μακεδόνες μὲν C (Salmasius): K. and R. suggest also the possibility of a lacuna. The 'Babylonians' here are probably due to a bold attempt to emend a dittography of προβεβλημένοι (or -μένοι as it appears in F).

¹¹ B (margin) E, K. and R.: τὸν στοῖχον F.

ASCLEPIODOTUS

παραθαρήνουσι πέντε δυνάμεισι πεφρουρημένον¹
οί δὲ μετὰ τὸ² πέμπτον ζυγόν, εἰ³ καὶ μὴ τὰς
σαρίσσας⁴ προάγουσι τοῦ μετώπου, ἀλλὰ τοῖς
γε σώμασιν ἐπιβρίθοντες ἀνελπιστίαν τοῖς πρωτο-
στάταις φυγῆς παρέχονται. ἔνιοι δὲ τὰς τοῦ
μετώπου προπιπτούσας ἀκμὰς ἐξισοῦσθαι βουλό-
μενοι τὰ δόρατα τῶν ὀπίσω ζυγῶν αὐξουσιν.

VI. Περὶ ψιλῶν τε καὶ πελταστῶν

Οἱ δὲ ψιλοὶ τε καὶ πελτασταὶ πρὸς τὰς ἀρμοζούσας
χρείας ὑπὸ τοῦ στρατηγοῦ ταγήσονται τότε μὲν
πρὸ⁵ τῆς φάλαγγος, τότε δὲ ὑπὸ τῆ φάλαγγι,
ἄλλοτε δὲ κατὰ δεξιὰ τε καὶ ἀριστερά· ὀνομάζεται
δὲ τὸ μὲν πρόταξις, τὸ δ' ὑπόταξις, τὸ δὲ προσέν-
ταξις· ἔστι δ' ὅτε καὶ ἐμπλεκόμενοι τῇ φάλαγγι
παρ' ἄνδρα τάττονται· λέγεται⁶ δὲ καὶ τοῦτο
παρένταξις, δι' ὅτι ἀνομοίων ἐστὶ παρένθεσις,
οἷον ψιλῶν παρ' ὀπλίτας· τὴν γοῦν τῶν ὁμοίων
παρένθεσιν, οἷον ὀπλιτῶν παρ' ὀπλίτας ἢ ψιλῶν
παρὰ ψιλοῦς—ῥηθήσεται⁷ γὰρ καὶ ἡ τούτων

¹ K. and R. suggest *πεφραγμένον* which appears in the parallel passage, Aelian, *Tactica*, xiv. 5.

² τὸν F.

³ B (margin) C (Salmasius) D, K. and R. : *εἶναι* F.

⁴ D, K. and R. : *τασ σαρισ* F (at end of line) : *ταῖς σαρίσσαις*
B (margin) C (Salmasius) E.

⁵ πρὸς F.

⁶ DE, *Lex. mil.* § 28, K. and R. : *λέγονται* F.

⁷ K. and R. suggest *εὔρεθήσεται*.

¹ This includes the file-leader himself.

TACTICS, v. 2 - VI. 1

protected as he is by the strength of five¹; while the men in the lines behind the fifth, though they cannot extend their spears beyond the front of the phalanx, nevertheless bear forward with their bodies at all events and deprive their comrades in the front ranks of any hope of flight. But some, who wish to bring all the projecting spear-points to the same distance in front of the line, increase the length of the spears of the rear ranks.²

VI. *Light Infantry and Targeteers*

The light infantry and targeteers will be stationed by the general as the situation demands, sometimes before the line of battle, sometimes behind it, and on other occasions now on the right flank and again on the left; the first is called van-position (*protaxis*), the second rear-position (*hypotaxis*), and the third flank-position (*prosentaxis*).³ Sometimes they are incorporated in the phalanx and stationed one beside each man; and this is called insert-position (*parentaxis*), because there is an insertion of different branches of the service, e.g., light infantry with hoplites; but the incorporation of like arms, such as hoplites beside hoplites or light infantry beside light infantry—the reason for this will be

¹ Cf. Aelian xiv. 7 and the Scholiast on the *Iliad*, N 130; but it is very doubtful if this was ever actually done.

³ The reasons for such positions are clear. The rear-position was the first in order of development, when the lighter troops served merely as reserves. Later they became an offensive weapon for the army.

ASCLEPIODOTUS

χρεία—, παρένταξιν¹ μὲν οὐκέτι, παρεμβολὴν δὲ ἐπονομάζουσι.

2 Λόχους μὲν δὴ καὶ οὗτοι τέσσαρας καὶ εἴκοσι καὶ χιλίους ἔξουσιν, εἰ μέλλουσι συμπαρεκτείνεσθαι τῇ φάλαγγι τῶν ὀπλιτῶν ὑποταττόμενοι, οὐ μὴν² ἀπὸ ἐξκαίδεκα ἀνδρῶν—ἤμισυ γὰρ αὐτῶν ἔστι τὸ πλῆθος—, ἀλλ' ἐξ ὀκτώ δηλονότι.

3 Ἔσται δὲ κατὰ τούτων τὸ μὲν ἐκ δ³ λόχων σύστασις ἔτι δὲ ἐκ δυεῖν συστάσεων⁴ πεντηκονταρχία, τὸ δὲ τούτου διπλάσιον ἑκατονταρχία, ἐφ' ἧς ἔσονται οἱ ἕκτακτοι,⁵ πέντε τὸν ἀριθμὸν, στρατοκῆρύξ τε καὶ σημειοφόρος καὶ σαλπικτής, ὑπηρέτης τε καὶ οὐραγός· τὸ δὲ τῆς ἑκατονταρχίας διπλάσιον <ψιλαγία, τὸ δὲ τούτου διπλάσιον ξεναγία, ἧς τὸ διπλάσιον⁶> σύστρεμμα, τούτου δὲ τὸ διπλοῦν ἐπιξεναγία, ἧς πάλιν τὸ διπλάσιον στίφος, οὗ δὴ συντεθέντος ἢ τῶν ψιλῶν γίνεται φάλαγξ, ἣν καὶ ἐπίταγμα καλοῦσιν ἔνιοι. ταύτης δὲ ἕκτακτοι⁷ ἄνδρες ὀκτώ, ἐπιξεναγοὶ⁷ μὲν τέσσαρες, συστρεμματάρχαι⁸ δὲ οἱ λοιποί.

¹ B (margin) C (Salmasius) E, K. and R.: *παρ' ὧν τάξιν* F.

² C (Salmasius), K. and R.: *ὕμιν* F.

³ *Lex. mil.* § 30, K. and R.: *δύο* F.

⁴ D, K. and R.: *συστάσεσι* F.

⁵ C (Salmasius), K. and R.: *ἕκτατοι* F.

⁶ These bracketed words are supplied by K. and R. from the corresponding passage in Aelian, *Tactica*, xvi. 3. See also *Lex. mil.* § 30. In substance they are without doubt correct and necessary.

⁷ K. and R. (*cf.* Aelian, *Tactica*, xvi. 4; *Lex. mil.* § 30): *ξεναγοὶ* F.

⁸ *οἱ συστρ.* K. and R. The omission of the article is attested also by the verbatim quotation in *Lex. mil.* § 30.

TACTICS, vi. 1 - 3

discussed later ¹—is not called insert-position, but rather interjection (*parembole*).²

Now these light infantry will also have 1024 files, if they are to stand behind the phalanx of the hoplites and extend the same distance, without, however, a depth of sixteen men—for they are only one-half as strong—but obviously of eight men.

With these, also, four files will form a squad (*systasis*), two squads a platoon (*pentekontarchia*), and double the platoon a company (*hekatontarchia*), to which will be attached the supernumeraries, five in number, an army-herald, a signal-man, a bugler, an aide-de-camp, and a file-closer. Two companies will form a battalion (*psilagia*), two of these a regiment (*xenagia*), the double of which will be a brigade (*systemma*), two brigades a division (*epixenagia*), the double of which will form a corps (*stiphos*), and where this is doubled we have the phalanx of light infantry, which some call also a supporting force (*epitagma*). To this are attached eight men as supernumeraries, four of whom are generals and the others brigadier-generals (*systemmatarchai*)³

¹ Cf. x. 17 below.

² In the definition of some of these terms Asclepiodotus differs from Aelian.

³ The importance of the light infantry is not adequately appreciated by Asclepiodotus. With each increase in the depth of the phalanx and, consequently, in its immobility, the light infantry became more necessary, until the Macedonian phalanx was helpless without it.

ASCLEPIODOTUS

VII. Περὶ τῶν ἰππέων

Οἱ δέ γε ἰππεῖς, ὥσπερ καὶ οἱ ψιλοί, πρὸς τὰς παρακολουθούσας χρείας τὴν τάξιν λαμβάνουσιν, καὶ μάλιστα αὐτῶν οἱ ἀκροβολισταί· οὗτοι γὰρ οἱ ἐπιτηδειότατοι πρὸς τὸ κατάρξαι τραυμάτων καὶ ἐκκαλέσασθαι πρὸς μάχην καὶ τὰς τάξεις διαλύσαι καὶ ἵππον ἀνακρούσασθαι καὶ τόπους ἀμείνους προκαταλαβεῖν καὶ τοὺς προκατειλημμένους ἀναλαβεῖν¹ καὶ τοὺς ὑπόπτους ἐρευνῆσαι καὶ ἐνέδρας παρασκευάσαι καὶ τὸ ὅλον προαγωνίσασθαι τε καὶ συναγωνίσασθαι· πολλὰ γὰρ δι' ὀξύτητα καὶ μεγάλα κατεργάζονται περὶ τὰς μάχας.

Τὰς δὲ τάξεις αὐτῶν κατὰ σχῆμα οἱ μὲν τετράγωνον πεποίησιν, οἱ δὲ ἑτερόμηκες, ἄλλοι δὲ ῥομβοειδές, καὶ ἕτεροι σφηνοειδές ἤτοι ἔμβολοειδές. κοινῶς δὲ ἅπαντες εἴλην² καλοῦσι τὸ σύστημα τοῦ σχήματος. τῇ μὲν οὖν ῥομβοειδεῖ τῶν εἰλῶν δοκοῦσι Θετταλοὶ κεχρησθαι πρῶτοι ἐν ἰππικῇ πολὺ δυναθέντες, πρὸς τε τὰς ἀποστροφὰς³ καὶ τὰς ἐπιστροφὰς τῶν ἵππων, ὅπως μὴ συνταράττοντο πρὸς πάσας τὰς πλευρὰς στρέφεσθαι δυνάμενοι· τοὺς γὰρ ἀρίστους τῶν ἰππέων κατὰ τὰς πλευρὰς ἔταττον,⁴ πάλιν τοὺς ἐξέχοντας ἀρετῇ κατὰ τὰς γωνίας· ἐκάλουν δὲ τὸν μὲν κατὰ τὴν πρόσω γωνίαν ἰλάρχη, τὸν δὲ κατὰ τὴν ὀπίσω οὐραγόν, τοὺς δὲ κατὰ τὴν δεξιὰν καὶ λαιὰν πλαγιοφύλακες.

¹ ἀναστεῖλαι K. and R.

² εἴλη F.

³ Oldfather: ἀπορίας F: ἀναστροφὰς K. and R.

⁴ D, K. and R.: ἐλάττων F.

VII. *The Cavalry*

Now the cavalry, like the light infantry, take their positions according to the demands of battle, and especially is this true of the skirmishers; for these are the most useful to draw first blood, to provoke the enemy to battle, to break their ranks, to repulse the horse, be the first to occupy points of advantage, carry such positions as the enemy have already occupied, reconnoitre terrain that looks suspicious, lay ambuscades, and in general to open and support the struggle; for by their swift manœuvring they render many valuable services in battle.¹

Now some order the horsemen in a square, others in an oblong rectangle, others in a rhomboid, and still others in a wedge-like or pointed formation. But all agree in calling the formation of the body a squadron. It appears that the Thessalians² were the first to use the rhomboid formation for their squadrons in cavalry fighting, and this with great success both in retreat and in attack, that they might not be thrown into disorder; since they were able to wheel in any direction; for they placed their crack troopers on the sides and the very best of these at the angles; and they called the man at the fore angle a squadron-commander (*ilarches*), the one at the rear angle a squadron-closer (*uragos*), and those on the right and left angles flank-guards (*plagiophylakes*).

¹ According to Aelian xvii these and other similar services are performed by the light infantry.

² Aelian adds that this was under Jason, but thinks that the formation was actually much older, and later attributed to him.

Asclep. vii. 1 = Ael. vii. 4-5. Asclep. vii 2 = Ael. xviii. 1-3.

ASCLEPIODOTUS

3 Τὰς δ' ἐμβολοειδεῖς Σκύθας ἐξευρεῖν καὶ Θρῶκας λέγεται, ὕστερον δὲ χρῆσασθαι καὶ Μακεδόνας ταύταις, ὡς εὐχρηστοτέραις¹ τῶν τετραγώνων· τὸ γὰρ μέτωπον τῶν ἐμβόλων βραχὺ² γινόμενον ὡσπερ καπὶ τῶν ῥομβοειδῶν, ὡνπερ ἡμισὺ ἐστι τὸ ἐμβολοειδέες, ῥάστην ἐποίει τὴν διίππευσιν, μετὰ τοῦ καὶ τοὺς ἡγεμόνας προβεβλήσθαι τῶν ἄλλων· καὶ τὰς ἀναστροφὰς εὐμαρεστέρας τῶν τετραγώνων ἐπὶ τούτων γίνεσθαι, πρὸς ἓνα τὸν ἰλάρχην ἀποβλεπόντων ἀπάντων, ὡς καὶ ἐπὶ τῆς τῶν γεράνων πτήσεως γίνεται.

4 Ταῖς δὲ τετραγώνους Πέρσαι τε καὶ Σικελοὶ καὶ Ἕλληνες ἐχρῶντο διὰ τὸ ἐν τούτοις δύνασθαι ζυγεῖν τε ἅμα καὶ στοιχεῖν τὰς εἵλας. πλὴν Ἕλληνες ἑτερομήκει τῷ πλήθει τὴν εἴλην ἐναλλάττοντες τῇ ὄψει τὸ σχῆμα τετράγωνον ἀπεδίδοσαν. δέκα γὰρ ἐξ κατὰ μῆκος, ὀκτὼ δὲ κατὰ βάθος³ ἄνδρας ἔταπτον, ἀλλ' ἐν διπλασίοις διαστήμασι διὰ τὰ τῶν ἵππων μεγέθη. ἔνιοι δὲ τριπλάσιον τὸ μῆκος τοῦ βάθους κατ' ἀριθμὸν ποιήσαντες τριπλάσιον διάστημα κατὰ βάθος ἀπέδωσαν, ὡστ' εἶναι πάλιν τὸ σχῆμα τετράγωνον, ὀρθότερον οὗτοι διανοηθέντες, οἴμαι· οὐδὲ⁴ γὰρ τὸ ἵππικὸν βάθος τῷ πεζῷ τὴν αὐτὴν ὠφελίαν παρέχει⁵ προσερεῖδόν τε⁶ καὶ συνέχον τὴν εἴλην,

¹ χρηστοτέραις C (Salmasius).

² σφόδρα ὀξὺ K. and R.; but βραχὺ is supported by the parallel passage in Aelian, *Tactica*, xviii. 4, although the recension ascribed to Arrian xviii. 4 reads τὸ μέτωπον ἐς ὀξὺ ἀπολήγον.

³ K. and R.: πλάθος F.

⁴ K. and R.: οὐχ ὅτι F.

⁵ K. and R.: οὐ παρέχει F.

⁶ προσερεῖδόν τε F.

¹ According to Aelian, under Philip.,

It is said that the Scythians and Thracians invented the wedge formation, and that later the Macedonians used it,¹ since they considered it more practical than the square formation; for the front of the wedge formation is narrow, as in the rhomboid, and only one-half as wide, and this made it easiest for them to break through, as well as brought the leaders in front of the rest, while wheeling was thus easier than in the square formation, since all have their eyes fixed on the single squadron-commander, as is the case also in the flight of cranes.²

The Persians, Sicilians, and Greeks regularly used the square formation since it can hold the squadrons in both rank and file; but the Greeks modified the squadron formation by making it an oblong in mass, while giving it to the eye the appearance of a square. For they drew up the riders with a front of sixteen and a depth of eight, but they doubled the interval between the riders³ because of the length of the horses. And some made the number of men in length three times that of the depth and then tripled the interval in depth, so that it again appeared to be a square, and these, in my opinion, had the better plan; since the depth of the cavalry unit, provided it is enough to hold the squadron firm and in line, does not have the same importance as in the infantry, rather it may work

² Compare the numerous passages on the flight of cranes collected by J. B. Mayor and J. E. B. Mayor in the former's edition of Cicero, *De Natura Deorum*, on ii. 125. See also Greg. Naz. *Orat.* 28. 25 (*Patr. Gr.* 36. 61 A), where the invention is ascribed to Palamedes, and the Schol. of Elias Cretensis (*Patr. Gr.* 36. 788 B).

³ That is, in the files, as compared with the interval between them in the ranks.

Asclep. vii. 3 = Ael. xviii. 4. Asclep. vii. 4 = Ael. xviii. 5-9.

ASCLEPIODOTUS

ἀλλὰ γὰρ¹ καὶ βλάβην ἐμποιεῖν οἶδε πλείω τῶν πολεμίων· ἐπιβάλλοντες γὰρ ἀλλήλοις ἑκταράτουσι τοὺς ἵππους, ὅθεν τετραγώνου μὲν ὄντος τοῦ ἀριθμοῦ δεήσει τὸ σχῆμα ποιεῖν ἑτερόμηκες, ἑτερομήκους δὲ ὄντος, εἰάν δέη ποιεῖν τετράγωνον, τριῶν ἢ τετάρων ἵπποτῶν³ εἶναι δεήσει τὸ βάθος καὶ πρὸς τοῦτό γε τὸ μῆκος ἐξισοῦσθαι.

5 Πλὴν ἔδοξε τὸ ῥομβοειδὲς ἀναγκαιότερον⁴ εἶναι πρὸς τὰς μεταγωγὰς διὰ τὴν πρὸς ἡγεμόνα νεῦσιν, καὶ δι' ὅτι ὁμοίως τῷ τετραγώνῳ καὶ ζυγεῖν δύναται καὶ στοιχεῖν, ὅθεν οἱ μὲν οὕτως αὐτὸ συνέταξαν, ὥστε φροντίσαι τοῦ συναμφοτέρου, ὅπως ἂν καὶ ζυγῇ καὶ στοιχῇ, οἱ δὲ οὔτε τοῦ ζυγεῖν οὔτε τοῦ στοιχεῖν ἐφρόντισαν, ἔνιοι δὲ τοῦ ζυγεῖν, οὐ μέντοι τοῦ στοιχεῖν, ἔνιοι δὲ ἀνάπαλιν.

6 Τοῖς μέντοι ζυγεῖν ἅμα καὶ στοιχεῖν αὐτὸ προελομένοις τέτακται τὸ μέγιστον⁵ ζυγὸν κατὰ μέσον ἐκ περιττοῦ ἀριθμοῦ οἶον⁶ δέκα καὶ ἑνὰς, οἶον ἐστὶ τὸ ἐκ τῶν $\bar{\alpha}\bar{\alpha}$ ἐν τῇ ὑποκειμένῃ διαγραφῇ· εἰτ' ἐφ' ἑκάτερα τοῦδε δύο ζυγὰ δυάδι αὐτοῦ λειπόμενα,⁷ πρόσω μὲν ὡς τὸ ἐκ τῶν $\beta\beta$ συγκείμενον, ὀπίσω δὲ ὡς τὸ ἐκ τῶν $\gamma\gamma$, ὥσθ' ἕκαστον τῶν β καὶ γ στοιχεῖν ἐκάστῳ τῶν $\bar{\alpha}$ πλὴν τῶν ἄκρων $\bar{\alpha}$ καὶ $\bar{\alpha}$. ἔπειτα ἐξῆς μετὰ μὲν τὸ β ζυγὸν τὸ ἐκ τῶν $\delta\delta$ δυάδι αὐτοῦ λειπόμενον, μετὰ δὲ τὸ γ τὸ⁸ ἐκ τῶν $\epsilon\epsilon$ καὶ τοῦτο δυάδι τοῦ γ λειπόμενον, ὥστε ἕκαστόν τε τῶν $\delta\delta$ ἐκάστῳ τῶν

¹ Om. by K. and R.

² Om. C (Salmasius).

³ ἵππων K. and R.

⁴ K. and R. suggest ἐπιτηδειότερον.

⁵ K. and R.: μέσον F.

⁶ K. and R.: τῶν F.

⁷ K. and R.: λειπόμενα F.

⁸ Added by K. and R.

¹ The idea behind these words is more clearly expressed

more havoc than the enemy themselves, for when the riders run afoul of one another they frighten the horses. Hence, if the number of the cavalry is a square number, they will have to be drawn up in an oblong rectangle, but if the number of men is not a square number and a square must be formed, the depth will have to be fixed at three or four horse-men and the front arranged accordingly.¹

And yet the rhomboid formation has seemed more necessary for manœuvring because it bears toward a leader and because, like the square, it is capable of both rank and file arrangement, for which reasons some have ordered it with this in mind, namely that attention be paid to both rank and file, others have paid attention to neither rank nor file, some to rank only and not to file, and still others the opposite.

Now by those who prefer to order the squadron by both rank and file the longest line is stationed in the middle, consisting of an odd number such as eleven, designated by the line $\alpha\alpha$ in the following diagram; then before and behind this line are two others, each two men less in number, the front $\beta\beta$, the rear $\gamma\gamma$, ordered so that each man in β and γ is in file with each in α except the two end men in α ; then again after the line β there comes the line $\delta\delta$, also two less in number, and after the line γ there comes the line $\epsilon\epsilon$, and this also is two less than the line γ , so that each man in the line $\delta\delta$ is in file with

Aelian xviii. 9: "When the number of riders in rank equals the number in file, the number is a square number, but the formation is an oblong rectangle, the depth of which is greater than its length; but when the formation of the squadron is a square the number of the horse-men in rank is different from that in file."

Asclep. vii. 5=Ael. xix. 1. 3. Asclep. vii. 6=Ael. xix. 4.

ASCLEPIODOTUS

ββ παρὰ τοὺς ἄκρους στοιχεῖν, καὶ ἕκαστον τῶν
 εἰ ἐκάστω τῶν γγ παρὰ τοὺς ἐσχάτους. ἔσον-
 ται δὴ τὰ μὲν κατὰ ββ καὶ γγ ζυγὰ ἀπὸ ἐννέα ἀνδρῶν,
 τὰ δὲ κατὰ δδ καὶ εἰ ἀπὸ ζζ, ὁμοίως δὲ τούτοις τὰ
 μὲν ἐφ' ἐκάτερα, οἷον τὸ ἐκ τῶν ζζ καὶ ηἠ¹
 ἔσται ἀπὸ πεντάδος, τὰ δ' ἔτι ἐξῆς ὡς τὸ ἐκ τῶν
 θθ καὶ τὸ ἐκ τῶν κκ ἀπὸ τριάδος. μονάδος δὲ
 λειπομένης² ἔστω³ ὁ πρόσω κατὰ⁴ τὸ λ ἰλάρχης,⁵
 ὁ δὲ ὄπιθεν καὶ κατὰ τὸ μ οὐραγός· πλαγιοφύ-
 λακες δὲ οἱ ἄκροι τοῦ αζυγοῦ, ὡσθ' εἶναι τὸ τῆς
 εἰλης πλῆθος ἀνδρῶν ἐνὸς καὶ ἐξήκοντα. τὸ δὲ
 ἀπὸ τοῦ αζυγοῦ ἐπὶ τὸν ἰλάρχην τρίγωνον
 σχῆμα ἔμβολόν τε καὶ σφηνοειδὲς ὀνομάζεται·
 ὑπογέγραπται δὲ οὕτως·

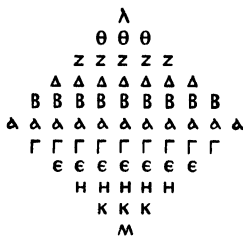

7 "Οσοις⁶ δ' ἤρесе τὴν εἰλην ζυγεῖν μὲν, οὐκέτι
 δὲ καὶ στοιχεῖν, τὸ μέγιστον καὶ μέσον ζυγὸν ἐκ
 περιπτῶν⁷ ἀνδρῶν ὡσπερ καὶ τὸ πρότερον πεποιη-
 κότες, οἷον τὸ αβγδεζη, τὰ ἐφ' ἐκάτερα
 μονάδι λειπόμενα τάττουσιν, ὡσπερ τὸ θικλμν

¹ Η F.

² K. and R. : λειπομένησ F.

³ ἔσται K. and R.

⁴ παρὰ K. and R.

⁵ ἰλάρχη F.

⁶ A (margin) C (Salmasius), K. and R. : ἴσοισ F.

⁷ C (Salmasius), K. and R. : μεσόζυγον περιπτῶν F.

TACTICS, vii. 6 - 7

each man in the line $\beta\beta$ except the end men, and each man in the line $\epsilon\epsilon$ is in file with each man in the line $\gamma\gamma$ except the last men; then the lines β and γ will be formed of nine men, and the lines δ and ϵ of seven men, and in the same manner will be ordered the lines after these, *i.e.*, the lines $\zeta\zeta$ and $\eta\eta$ will have five men, and the lines θ and κ three men; and of the remaining lines of one man each let the front one λ be a squadron-commander (*ilarches*) and the rear one μ be a squadron-closer (*uragos*); and the flank-guards will be the men on the ends of line α , so that the strength of the entire squadron will be sixty-one men. The triangle from the middle line to the squadron-commander is called a ram and wedge-shaped. The figure follows:

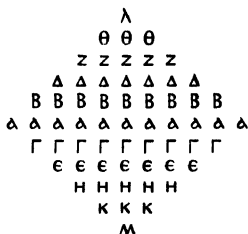

Those who prefer to order the squadron by rank and not by file, make the longest and centre rank odd in number as above, as $\alpha\beta\gamma\delta\epsilon\zeta\eta$,¹ and then place, before and behind, ranks one man less in number, as the ranks $\theta\iota\kappa\lambda\mu\nu$, so that θ is not in

¹ From here on the diagram after § 9 is in mind.

Asclep. vii. 7 = Ael. xix. 13.

ASCLEPIODOTUS

ζυγόν, ὥστε τὸ θ μήτε τῷ α μήτε τῷ β στοιχεῖν,
 ἀλλ' ἐν τῷ μεταξὺ αὐτῶν κείσθαι εἰς τοῦμπροσθεν,
 ὡς αὐτως δὲ καὶ τῶν β̄γ̄ τὸ ι καὶ τῶν γ̄δ̄ τὸ κ̄ καὶ
 τὸ λ̄ τῶν δ̄ε̄, τὸ δὲ μ̄ τῶν ε̄ζ̄ καὶ τῶν ζ̄η̄ τὸ ν̄.
 οὕτω γὰρ κειμένωνν οὐδὲ εἰς τῶν ἐν τῷ θ̄ικ̄λ̄μ̄ν¹
 ζυγῷ οὐδενὶ τῶν ἐν τῷ ᾱβ̄γ̄δ̄ε̄ζ̄η̄ στοιχήσει.
 ὁμοίως δὲ καὶ τὸ ξ̄ο̄π̄ρ̄σ̄ ζυγόν ἐμπροσθεν τοῦ
 θ̄ικ̄λ̄μ̄ν τάσσουσιν, ὥστε τὸ ξ̄ μήτε τῷ θ̄ μήτε
 τῷ ι² ἐπ' εὐθείας εἶναι, ἀλλ' ἐν τῷ³ μεταξὺ τόπω
 καὶ κατὰ τὸ β̄ τοῦ πρώτου ζυγοῦ, καὶ τὸ ο̄ μεταξὺ
 τοῦ ικ̄⁴ ὡς κατὰ τὸ γ̄, καὶ τὸ π̄ μεταξὺ τῶν κλ̄ ὡς
 κατὰ τὸ δ̄, τὸ δὲ ρ̄ μεταξὺ τῶν λμ̄ ὡς κατὰ τὸ ε̄,⁵
 καὶ τὸ σ̄⁶ μεταξὺ τῶν μν̄ κατὰ τὸ ζ̄.⁷ οὕτω γὰρ
 τὸ ξ̄ο̄π̄ρ̄σ̄ ζυγόν οὐδενὶ τῶν ἐν τῷ παρεδρεύοντι
 ζυγῷ στοιχήσει, οἷον τῷ θ̄ικ̄λ̄μ̄ν, ἀλλὰ τῷ παρ'
 ἔν,⁸ οἷον τῷ ᾱβ̄γ̄δ̄ε̄ζ̄η̄. ἔσται τοίνυν καὶ τὸ ἐξ̄η̄ς
 ζυγόν οἷον τὸ τῷφ̄χ̄ τῷ μὲν πρὸ αὐτοῦ μὴ στοιχοῦν
 τῷ ξ̄ο̄π̄ρ̄σ̄,⁹ τῷ δὲ παρ' ἔν, οἷον τῷ θ̄ικ̄λ̄μ̄ν, καὶ τὸ
 ψ̄ω̄ς¹⁰ τῷ¹¹ μὲν τῷφ̄χ̄ οὐ στοιχήσει,¹² τῷ δὲ παρὰ
 τοῦτο ξ̄ο̄π̄ρ̄σ̄, τὸ δὲ ἰ̄ἰ̄ οὐ στοιχήσει τῷ ψ̄ω̄ς,¹³
 τῷ δὲ παρὰ τοῦτο τῷφ̄χ̄.¹³ ὁ δὲ ᾱ ἰλάρχης μεταξὺ
 μὲν ἔσται τῶν ἰ̄ἰ̄,¹⁴ ἐπ' εὐθείας δέ τινι τῶν ἐν
 τῷ ψ̄ω̄ς¹⁵. καὶ τούτῳ δὲ τῷ ἐμβόλω καὶ τὸν
 ὄπισθεν ἴσον τάξαντες συμπληροῦσι τὴν εἰλην, ἧς
 ὁ μὲν ᾱ ἔσται ἰλάρχης, οὐραγὸς δὲ ᾱ¹⁶ ὁ ἔσχατος
 τῶν δυεῖν ἐμβόλων, οἱ δὲ ᾱη̄¹⁷ πλαγιοφύλακες.
 καὶ φανερόν, ὅτι τῆς τοιαύτης εἰλης εἰ καὶ μὴ

¹ ικ̄λ̄μ̄ν F.

² K. and R.: κ̄ F.

³ K. and R.: ἀλλὰ τῷ F.

⁴ K. and R.: ι καὶ κ̄ F.

⁵ K. and R.: ι F.

⁶ K. and R.: Γ F.

⁷ K. and R.: ζ̄ F.

⁸ K. and R.: ἐνα F.

⁹ K. and R. added σ.

TACTICS, vii. 7

file with either α or β but stands before and between them, and in the same manner ι between $\beta\gamma$, κ between $\gamma\delta$, λ between $\delta\epsilon$, μ between $\epsilon\zeta$, and ν between $\zeta\eta$. When the ranks are so ordered not a man in the rank $\theta\iota\kappa\lambda\mu\nu$ will be in file with a man in the rank $\alpha\beta\gamma\delta\epsilon\zeta\eta$. After the same fashion they place the rank $\xi\omicron\pi\rho\sigma$ before the rank $\theta\iota\kappa\lambda\mu\nu$, so that ξ is not directly before either θ or ι , but is in their interval and in line with β of the first rank, \omicron is between $\iota\kappa$ and in line with γ , π is between $\kappa\lambda$ and in line with δ , ρ between $\lambda\mu$ and in line with ϵ , and σ between $\mu\nu$ and in line with ζ . For by this arrangement the rank $\xi\omicron\pi\rho\sigma$ will not be in file with the nearest rank $\theta\iota\kappa\lambda\mu\nu$, but with the second rank $\alpha\beta\gamma\delta\epsilon\zeta\eta$. So also the next rank $\tau\nu\phi\chi$ will not be in file with the one immediately preceding it $\xi\omicron\pi\rho\sigma$, but with the second rank $\theta\iota\kappa\lambda\mu\nu$, the rank $\psi\omega\varsigma$ will not be in file with $\tau\nu\phi\chi$, but with the one beyond it $\xi\omicron\pi\rho\sigma$, and the rank $\uparrow\uparrow$ will not be in file with the rank $\psi\omega\varsigma$, but with the one beyond it $\tau\nu\phi\chi$; and the squadron-commander α will be between $\uparrow\uparrow$, and directly before someone in the rank $\psi\omega\varsigma$. Now since they place a wedge behind, exactly like the one in front, they complete the squadron, which will have α as a squadron-commander, α the last man in the two wedges as a squadron-closer, and $\alpha\eta$ as flank-guards. And it is apparent that in such a squadron, though the

¹⁰ K. and R. added $\bar{\epsilon}$.

¹¹ K. and R. : $\kappa\alpha\iota\ \tau\omega\ \text{F}$.

¹² C (Salmasius), K. and R. : $\sigma\upsilon\sigma\tau\omicron\iota\chi\eta\sigma\epsilon\iota\ \text{F}$.

¹³ K. and R. : a series of certain emendations for the corrupt $\text{παρὰ τοῦτο καὶ το } \rho\bar{\sigma} \text{ τῶ παρὰ τὸ } \psi\omega\bar{\zeta}\ \text{F}$.

¹⁴ K. and R. : $\tau\omega\ \uparrow\zeta\ \text{F}$.

¹⁵ K. and R. : $\tau\omega\ \bar{\psi}\omega\ \text{F}$.

¹⁶ Supplied by K. and R.

¹⁷ B (?), K. and R. : $\lambda\bar{\eta}\ \text{F}$.

ASCLEPIODOTUS

τὰ συνεχῆ ζυγὰ στοιχεῖ, ἀλλὰ τὰ ἐν παρ' ἐν κείμενα.

- 8 Ἐπει¹ δὲ συνέβη ζυγεῖν μὲν, οὐ στοιχεῖν δέ, τοῦτο ἡμῶν φροντιζόντων, στοιχεῖν λέγεται εἶ γε μόνως ἐν τῇ τάξει φροντίζομεν πρώτου τοῦ¹ κατὰ τὸν ἰλάρχην τε καὶ οὐραγὸν στίχου, οἷον τοῦ $\bar{a}\bar{\omega}\bar{\pi}\bar{\delta}\bar{\pi}\bar{\omega}\bar{a}$ καὶ τῶν ἐφ' ἐκάτερα,² οἷον $\bar{\eta}\bar{\nu}\bar{k}\bar{\kappa}\bar{\nu}\bar{\eta}$ ³ καὶ $\bar{\eta}\bar{\phi}\bar{\lambda}\bar{\lambda}\bar{\phi}\bar{\eta}$,⁴ ἔπειτα τῶν μετὰ τοῦσδε, οἷον τοῦ $\bar{\psi}\bar{o}\bar{\gamma}\bar{o}\bar{\psi}$ ⁵ καὶ τοῦ $\bar{\varsigma}\bar{r}\bar{e}\bar{r}\bar{\varsigma}$,⁶ εἶτα τῶν ἐφεξῆς, τοῦτ' ἔστι τοῦ τε $\bar{\tau}\bar{i}\bar{i}\bar{\tau}$ ⁷ καὶ τοῦ $\bar{\chi}\bar{\mu}\bar{\mu}\bar{\chi}$,⁸ καὶ τῶν μετὰ τούτους $\bar{\xi}\bar{\beta}\bar{\xi}$ ⁹ καὶ $\bar{o}\bar{\zeta}\bar{o}$, καὶ ἔτι τῶν παρὰ τούτους τοῦ¹⁰ τε $\bar{\theta}\bar{\theta}$ καὶ τοῦ $\bar{\nu}\bar{\nu}$ καὶ τελευταίων τῶν κατὰ τοὺς πλαγιοφύλακες, καὶ¹¹ οὐδὲν μὲν διοίσει κατὰ τὴν θέσιν τοῦ ζυγοῦντος¹² μὲν, μὴ στοιχοῦντος δέ, τῇ δ' ἡμετέρα λήψει τῆς τάξεως καὶ τῇ φροντίδι στοιχήσει μὲν, δι' ὅτι οἱ τεταγμένοι κατὰ στοιχὸν ἀλλήλους συνέχουσιν, οὐ ζυγήσει δέ, ὅτι ὁ πρῶτος τοῦ πρώτου στοιχοῦ, οἷον ὁ \bar{a} , τῷ τοῦ δευτέρου πρώτῳ, οἷον τῷ $\bar{\eta}$ ¹³, οὐκ ἐπ' εὐθείας ἐστὶν κατὰ τὸ ζυγεῖν.¹⁴
- 9 Ἀλλὰ¹⁵ καὶ ὅσοι μῆτε ζυγεῖν μῆτε στοιχεῖν μάλλον τὴν εἴλην προὔθυμήθησαν, ἄλλον τρόπον εἰς ταύτην ἐπήνεσαν τὴν θέσιν.¹⁵ τάσσοуси γὰρ

¹ The tentative restoration of this extremely corrupt passage follows the lines marked out by K. and R., with some simplifications. ἐπειδὴ συνέβημεν οὐ τοῦτο δὲ ἡμῶν φροντιζόντων ζυγεῖν λέγεται μόνως ἐν γε (εἰ δὲ C) ἐν τῇ τάξει φροντίζομεν τοῦ F: ἐπεὶ δὲ συνέβη ζυγεῖν μὲν, οὐ στοιχεῖν δὲ τοῦτο ἡμῶν φροντιζόντων, οὐ ζυγεῖν λέγεται μὲν, στοιχεῖν δέ, εἰ γε μόνως ἐν τῇ τάξει φροντίζομεν πρώτου τοῦ K. and R.

² ἐκάτερα F: ἐκάτερα AC (Sulmasius).

³ K. and R.: $\zeta\bar{\gamma}\bar{k}\bar{\gamma}\zeta$ F.

⁴ K. and R.: $\bar{\eta}\bar{\phi}\bar{\lambda}\bar{\lambda}\bar{\phi}\bar{\eta}$ F.

⁵ K. and R.: $\bar{\psi}\bar{o}\bar{\gamma}\bar{\psi}$ F.

⁶ K. and R.: $\bar{\varsigma}\bar{r}\bar{e}\bar{\varsigma}$ F.

successive ranks are not in file, the alternate ones are.

Though, when considered in the foregoing manner, the squadron happens to be ordered by ranks and not by files, it is still said to be in file formation, if only we regard the formation of the first file from squadron-commander to squadron-closer, namely the file $\alpha \omega \pi \delta \pi \omega \alpha$, and those on each side of it, namely $\uparrow \upsilon \kappa \kappa \upsilon \uparrow$ and $\uparrow \phi \lambda \lambda \phi \uparrow$, then the following files $\psi \omicron \gamma \omicron \psi$ and $\varsigma \rho \epsilon \rho \varsigma$, further the next in order $\tau \iota \iota \tau$ and $\chi \mu \mu \chi$, then the next $\xi \beta \xi$ and $\sigma \zeta \sigma$, the successive ones $\theta \theta$ and $\nu \nu$, and finally the flank-guards. Now such a formation will in no way differ from that called the ordering by rank and not by file, and yet in our apprehension and conception of the ordering it will be by file, because the men are contiguous in file, but it will not be by rank, since the first man in the first file, namely α , is not directly before the first man in the second file, namely \uparrow , by rank.

But those who wish to draw up the squadron neither by rank nor by file, prefer another arrangement for this formation; for they first station as a Asclep. vii. 8 = Ael. xix. 11. Asclep. vii. 9 = Ael. xix. 6-10.

⁷ τοῦ τε $\tau\epsilon\tau$ added by K. and R. after C (Salmasius), which has $\delta\epsilon$ (for $\tau\epsilon$).

⁸ C (Salmasius), K. and R.: *ἔστιν καὶ τοῦ $\chi\mu\mu\chi$* F.

⁹ $\xi\beta\xi$ F, K. and R. (misprint).

¹⁰ K. and R.: $\tau\omega\upsilon\upsilon$ F.

¹¹ Added by K. and R.

¹² $\zeta\rho\epsilon\rho\zeta$ F.

¹³ K. and R.: τ F.

¹⁴ The last three words are added by K. and R. (from C?).

¹⁵ K. and R., following in the main C (Salmasius), which, however, has *μηδὲ στοιχεῖν . . . προθυμηθησαν . . . ἐπήνεσαν θέσιν*: F has *ἄσοι μὴ τε στοιχεῖν μὴ δὲ ζυγεῖν κατὰ τὸ τὸ ζυγὸν ἄλλον τρόπον μάλλον τὴν εἰλημ προθυμηθεῖσαν εἰς αὐτὴν ἐπαινησον τὴν θέσιν*.

face and a kind of rank of the squadron the opposite sides of the rhomboid $\alpha\theta\xi\tau\psi\uparrow\alpha\uparrow\varsigma\chi\sigma\nu\eta$, like the letter Δ , then, in order, the line two men less in number $\theta\beta\iota\omicron\nu\omega\phi\rho\mu\zeta\nu$, then the line $\xi\iota\gamma\kappa\pi\lambda\epsilon\mu\sigma$ also two men less than the one before it, with the man at the centre corner leading each line, *i.e.*, the men $\alpha\omega\pi$; then the line $\tau\omicron\kappa\delta\lambda\rho\chi$ whose leader is δ , then the line $\psi\nu\pi\phi\varsigma$, behind it $\uparrow\omega\uparrow$, and last a squadron-closer α . It is clear, then, that such an arrangement will not differ from the former ones save in conception only, as will be evident from the diagram.¹



The cavalry force is stationed, like the light infantry, sometimes before the phalanx, sometimes

¹ After one has observed the great care with which our author dwells upon these different formations, man by man, rank by rank, file by file, he is rather surprised to find that they differ only in the way one looks at them—that, in fact, paragraphs 7-9 are to be taken in a Pickwickian sense.

Asclep. vii. 10=Ael. xx. 1.

⁸ Supplied by K. and R.

⁹ K. and R. : $\epsilon\tilde{\omega}\bar{\alpha}F$.

¹⁰ After *φάλαγγος* F has the dittography *τότε δε ὑπὸ τῆς φάλαγγος*. τότε δε ὑπὸ τῆς φάλαγγος.

ASCLEPIODOTUS

λαγγι, ἄλλοτε δ' ἐκ πλαγίων, ὅθεν καὶ τούτων τὸ πλῆθος φάλαγγα μὲν οὐ καλοῦσιν, ἐπίταγμα δέ, ὡσπερ καὶ τὸ τῶν ψιλῶν, δι' ὅτι ἐπὶ τῇ φάλαγγι τάττονται¹ πρὸς τὰς παρακαλούσας αὐτὴν χρείας.

- 11 Τὰς μὲν οὖν δύο εἶλας ἐπιλαρχίαν ὠνόμασαν, τὰς δὲ δύο ἐπιλαρχίας Ταραντιναρχίαν,² τὰς δὲ δύο Ταραντιναρχίας³ ἵππαρχίαν, τὰς δὲ δύο ἵππαρχίας ἐφιππαρχίαν, τὸ δὲ διπλοῦν τῆς ἐφιππαρχίας τέλος ἀνάλογον τῷ κέρατι τῆς φάλαγγος. ἀπὸ γοῦν τῶν δύο τελῶν τὸ ὄλον ἐπίταγμα γίνεται ἀνάλογον τῇ φάλαγγι.

VIII. Περὶ ἀρμάτων

Τῶν δὲ ἀρμάτων καὶ ἐλεφάντων εἰ καὶ τὴν χρῆσιν σπανίζουσιν εὐρίσκομεν, ἀλλ' ὁμῶς πρὸς τὸ τέλειον τῆς γραφῆς τὰς ὀνομασίας ἐκθησόμεθα. καλοῦσι τοῖνον τὰ μὲν δύο ἄρματα ζυγαρχίαν, τὰς δὲ δύο ζυγαρχίας συζυγίαν, δύο δὲ συζυγίας ἐπισυζυγίαν, δύο δὲ ἐπισυζυγίας ἀρματαρχίαν, καὶ τὸ ἐκ τῶν³ ἀρματαρχιῶν κέρασ, οὐ τὸ διπλάσιον φάλαγγα. πλείοσι δὲ φάλαγγι ἀρμάτων χρώμενον⁴ ἔξεστι ταῖς αὐταῖς ὀνομασίαις συγκεχρησθαι.⁵ ἔστι δὲ τῶν ἀρμάτων τὰ μὲν ψιλὰ, τὰ δὲ δρεπανηφόρα κατὰ τοὺς ἄξονας.

IX. Περὶ ἐλεφάντων

Ἐπὶ δὲ τῶν ἐλεφάντων ὁ μὲν ἐνὸς ἐλέφαντος ἄρχων ζῶαρχος ὀνομάζεται, ὁ δὲ δυεῖν θήραρχος

¹ K. and R. : τάττειν F.

² K. and R. (from Arrian and Ael. *Tact.* xx. 2; *Lex. mil.* § 32); ταραντιναρχίαν and -τιναρχίας F.

³ δυοῖν K. and R.

behind it, and at other times on the flanks, for which reason this arm of the service is called a supporting force (*epitagma*), as in the case of the light infantry, and not a phalanx, because it is attached to the phalanx according as need for it arises.

Now two squadrons are called a battalion (*epilarchia*), two battalions a Tarentine regiment (*Tarantinarchia*), two Tarentine regiments a brigade (*hipparchia*), two brigades a division (*ephipparchia*), and the double of the division a complement (*telos*), corresponding to the wing of the phalanx. The two complements form the entire supporting force (*epitagma*), corresponding to the phalanx.¹

VIII. Chariots

Although we rarely find any use for chariots and elephants, we shall, nevertheless, set forth their nomenclature to complete this discussion. Two chariots are called a pair (*zygarchia*), two pairs a double-pair (*syzygia*), two double-pairs a chariot-unit (*episyzygia*), two chariot-units a chariot-line (*harmatarchia*), two chariot-lines a wing (*keras*), and the double of this a phalanx. If several phalanxes of chariots are to be used, the same nomenclature may be employed. Some of the chariots have no offensive weapons, while others carry scythes on the axles.

IX. Elephants

In the branch of the elephants the leader of a single elephant is called an animal-commander

¹ That is, the phalanx of light infantry (*cf.* vi. 3).
 Asclep. vii. 11 = Ael. xx. 2. Asclep. viii = Ael. xxii.
 Asclep. ix = Ael. xxiii.

⁴ χρωμένω K. and R.

⁵ συνκεχρησθαι F.

ASCLEPIODOTUS

καὶ τὸ σύστημα θηραρχία, ὁ δὲ τεσσάρων ἐπι-
θήραρχος καὶ ἐπιθηραρχία τὸ σύστημα, ὁ δὲ τῶν
ὀκτὼ ἰλάρχης, τῶν δὲ ἑξκαίδεκα ἐλεφαντάρχης,
κεράρχης δὲ ὁ τῶν δύο καὶ τριάκοντα, ὁ δὲ τῶν
διπλασιῶνων φαλαγγάρχης, καὶ ὁμωνύμως τὸ
σύστημα καθ' ἑκάστην ἀρχὴν κεκλήσεται.

X. Περὶ τῶν κατὰ τὴν κίνησιν ὀνομασιῶν

Τὰ μὲν οὖν εἶδη τῆς τελείας δυνάμεως καὶ τὰ
ὀνόματα τῶν ἐν αὐτῇ ταγμάτων εἴρηται· ἐξῆς
δὲ περὶ τῶν ὀνομάτων ἀκόλουθον λέγειν, οἷς
χρῶμενοι μεταρρυθμίζουσι¹ οἱ στρατηγοὶ τὰς
φάλαγγας· φασὶ γὰρ τὸ μὲν τι κλίσιω² ἐπὶ δόρυ
ἢ ἐπ' ἀσπίδα, τὸ δὲ μεταβολὴν καὶ ἐπιστροφὴν,
ἄλλο καὶ ἀναστροφὴν, ἕτερον καὶ περισπασμόν³
καὶ ἐκπερισπασμόν, ἀποκατάστασιν τε καὶ ἐπι-
κατάστασιν, στοιχεῖν τε καὶ ζυγεῖν⁴ καὶ εἰς ὀρθὸν
ἀποδοῦναι καὶ ἐξελίσειν⁵ καὶ διπλασιάζειν· φασὶ
δέ τι καὶ ἐπαγωγὴν καὶ παραγωγὴν δεξιὰν ἢ
λαίαν καὶ⁶ πλαγίαν φάλαγγα καὶ ὀρθίαν καὶ λοξήν,
καὶ παρεμβολὴν καὶ παρένθεσιν, πρόταξιν⁷ τε καὶ

¹ K. and R. write with one ρ and so apparently F.

² K. and R.: κλήσιω F.

³ Added by K. and R. from Arrian and Aelian, *Tactica*,
xxiv. 2 (cf. § 7 below): ἕτερον καὶ ἐκπερισπασμόν F.

⁴ These four words are omitted by K. and R but
supported by the parallel passage in Arrian and Aelian,
Tactica, xxiv. 2; cf. ch. x. § 11 below, last note.

⁵ K. and R.: ἐξελεῖν F.

⁶ K. and R.: καὶ κατὰ F (but cf. Arrian and Aelian, *l.c.*,
§ 3, and § 21 below).

⁷ K. and R.: ταξίω F.

TACTICS, IX. 1 - X. 1

(*zoarchos*), the commander of two a beast-commander (*therarchos*) and his command a beast-unit (*therarchia*), the commander of four a top-beast-commander (*epitherarchos*) and his command a top-beast-unit (*epitherarchia*), the commander of eight a troop-commander (*ilarches*), of sixteen an elephant-commander (*elephantarches*), of thirty-two a wing-commander (*kerarches*), and of double this number a phalanx-commander (*phalangarches*); corresponding names will be given to each unit.¹

X. *The Terms used for military Evolutions*

The different branches of the entire army and the names of its lesser divisions have now been given; it remains to consider in turn the terms used by the commanders in manœuvring the divisions of the phalanx. For they use first 'right-' or 'left-face' (*klisis*), then 'about-face' (*metabole*) and 'quarter-turn' (*epistrophe*), also 'back-turn' (*anastrophe*), further 'half-turn' (*perispasmos*) and 'three-quarter-turn' (*ekperispasmos*) and 'return-to-original-position' (*apokatastasis*) and 'advance-to-original-position' (*epikatastasis*), 'order files' (*stoichein*) and 'order ranks' (*zygein*), also 'lines front' (*eis orthon apodunai*) and 'counter-march' (*exeligmos*) and 'doubling' (*diplasiasmos*); they use also 'march-in-column' (*epagoge*) and 'march-in-line' (*paragoge*), and these either 'to the right' or 'to the left,' 'extended front,' 'column formation,' and 'oblique front' (*plagia, orthia, loxe phalanx*), 'interjection' (*parembole*) and 'insertion' (*parenthesis*), and

¹ It is very doubtful if such terms as these were known outside the class-rooms of the philosophic strategists.

ASCLEPIODOTUS

- ὑπόταξιν¹ καὶ ἐπίταξιν, ὧν ἕκαστον ὃ τι σημαίνει, δηλώσαι διὰ βραχέων πειρασόμεθα.
- 2 Κλίσις μὲν οὖν ἐστὶν ἢ κατ' ἄνδρα κίνησις, ἐπὶ δόρῳ μὲν ἢ ἐπὶ δεξιᾷ, ἐπ' ἀσπίδα δὲ ἢ ἐπ' ἀριστερά, ἐπὶ δὲ τῶν ἵπποτων² ἐφ' ἡνίαν· γίνεται δὲ κατὰ τὰς ἐκ πλαγίων ἐφόδους τῶν πολεμίων ἀντιπορίας χάριν ἢ ὑπερκεράσεως³ ὅπερ ἐστὶν ὑπερβαλέσθαι τὸ κέρας τῶν πολεμίων.
- 3 Ἡ δὲ δις ἐπὶ τὸ αὐτὸ γινομένη⁴ κλίσις κατὰ νότου τὰς τῶν ὀπλιτῶν ὄψεις μετατιθεῖσα καλεῖται μεταβολή, ἧς δύο διαφοραί, ἢ μὲν ἀπὸ τῶν πολεμίων, ἦν καὶ ἐπ' οὐρὰν ἐπονομάζουσιν, ἢ δ' ἐπὶ τοὺς πολεμίους ἀπ' οὐρᾶς⁵ καλουμένη.
- 4 Ἐπιστροφὴ δὲ ἐστὶν, ὅτ' ἂν πυκνώσαντες ὄλον τὸ σύνταγμα κατὰ λόχον τε καὶ ζυγὸν ὡς ἐνὸς ἀνδρὸς σῶμα κλίνωμεν, ὡς ἂν περὶ κέντρον περὶ τὸν πρῶτον λοχαγόν,⁶ εἰ μὲν ἐπὶ δόρῳ, τὸν δεξιόν, εἰ δὲ ἐπ' ἀσπίδα, τὸν ἀριστερὸν ὄλου⁷ τοῦ συντάγματος περινευχθέντος καὶ μεταλαβόντος⁸ τὸν ἔμπροσθεν τόπον καὶ ἐπιφάνειαν, ἐπὶ δόρῳ μὲν τὴν ἐκ δεξιῶν, ἐπ' ἀσπίδα δὲ τὴν ἐπὶ λαιάν.
- 5 Οἷον ἔστω σύνταγμα τὸ $\bar{\alpha}\beta\gamma\delta$,⁹ λοχαγῶν¹⁰ δ' ἐν αὐτῷ ζυγὸν τὸ $\bar{\alpha}\beta$. δηλον δέ, ὅτι δεξιὸς μὲν ἔσται λοχαγὸς ὁ¹¹ κατὰ τὸ β , λαιὸς δὲ ὁ κατὰ τὸ $\bar{\alpha}$,

¹ ὑπίταξιν F.

² K. and R. suggest ἱππέων.

³ A and B in margin, K. and R.: ἡ υπερασσω F.

⁴ γινομένη K. and R.: γινομένη is attested also in *Lex. mil.*

§ 34.

⁵ ἀπουραο F.

⁶ K. and R. (λοχαγὸν C, the second περὶ suggested by K. and R.): περικεντρον πρῶτον λόγον F.

⁸ K. and R.: μεταβάλλοντος F.

⁷ ὄλου F.
⁹ $\bar{\alpha}\beta\gamma$ F.

¹⁰ K. and R.: λοχαγὸν F.

¹¹ Supplied by K. and R.

¹ The great confusion of these terms during this period
294

TACTICS, x. 1 - 5

'van-position' (*protaxis*), 'rear-position' (*hypotaxis*), and 'supporting-position' (*epitaxis*). The signification of each of these terms we shall endeavour to explain as briefly as possible.¹

Right- or left-facing, then, is the movement of the individual men, 'by spear' to the right, and 'by shield'—called in the cavalry 'by reiu'—to the left; this takes place when the enemy falls upon the flanks and we wish either to counter-attack, or else to envelop his wing, *i.e.*, overlap the wing of the enemy.

The double turning, which is performed in the same way, whereby the soldiers face about to the rear, is called an about-face (*metabole*), of which there are two kinds, the one from the enemy, called 'to the rear' (*ep' uran*), and the other toward the enemy, called 'from the rear' (*ap' uras*).

It is a quarter-turn, when we close up the entire battalion by file and rank in the compact formation² and move it like the body of one man in such a manner that the entire force swings on the first file-leader as on a pivot, if to the right on the right file-leader, and if to the left on the left file-leader, and at the same time takes a position in advance and faces 'by spear' if pivoting right and 'by shield' if pivoting left.

Let the battalion, for example,³ be $\alpha\beta\gamma\delta$, and $\alpha\beta$ its rank of file-leaders; it is clear, then, that the right file-leader will be the one at β and the left the one at α . This was probably due to the fact that such discussions had lost all contact with the drill-ground.

² That is, two cubits apart.

³ The diagrams to explain this and the following evolutions will be found on p. 301.

Asclep. x. 2 = Ael. xxv. 1. Asclep. x. 3 = Ael. xxv. 2-4.

Asclep. x. 4 = Ael. xxv. 5.

ASCLEPIODOTUS

καὶ ἐπὶ δόρυ μὲν τὰ κατὰ τὸ β μέρη, ἐπ' ἀσπίδα δὲ τὰ κατὰ τὸ α· μένοντος τοίνυν τοῦ β, εἰ ἐπιστρέφομεν ὅλον τὸ ᾱβ̄γ̄δ̄ σύνταγμα ἐπὶ δόρυ, τὸ κατὰ τὴν ᾱβ̄ ζυγὸν μεταστήσεται ἐπὶ τὴν πρὸς ὀρθὰς αὐτῷ θέσιν τὴν β̄ε̄ καὶ ὅλον τὸ β̄ᾱδ̄γ̄¹ ἔσται ὡς τὸ β̄ε̄ξ̄η̄ ἐπεστραμμένον ἐπὶ δόρυ καὶ κατειληφὸς² τόπον μὲν τὸν ἔμπροσθεν, ἐπιφάνειαν δὲ τὴν δεξιάν.

6 Ἀναστροφή δὲ ἐστὶν ἀποκατάστασις τῆς ἐπιστροφῆς εἰς ὄν³ προκατεῖχε τὸ σύνταγμα τόπον, οἷον τὸν κατὰ τὸ ᾱβ̄γ̄δ̄.⁴

7 Περισπασμὸς δὲ ἐστὶν ἡ⁵ ἐκ δυεῖν ἐπιστροφῶν τοῦ συντάγματος κίνησις κατὰ τὸ αὐτὸ μέρος ὡς τὸ β̄θ̄κ̄λ̄· τῆς μὲν γὰρ πρώτης ἐπιστροφῆς τῆς κατὰ τὸ β̄ε̄ξ̄η̄ ἐπέχει τόπον μὲν τὸν ἔμπροσθεν, ἐπιφάνειαν δὲ τὴν δεξιάν, τῆς δ' ἐξ ἀρχῆς θέσεως τῆς ᾱβ̄γ̄δ̄ εἰς⁶ τοῦπίσω βλέπει.

8 Ἐκπερισπασμὸς δὲ ἐστὶν, ὅτ' ἂν ἐκ τριῶν ἐπιστροφῶν ἐπὶ τὰ αὐτὰ συνεχῶν κινῆται⁸ τὰ σύνταγματα εἰς τὸν ὄπισθεν τόπον καὶ τὴν εἰς λαίον ἐπιφάνειαν, καθάπερ ἔχει τὸ β̄μ̄ν̄ξ̄, τοῦ μὲν β̄θ̄ κ̄λ̄ εἰς τοῦμπροσθεν κατὰ τὴν δεξιάν κείμενον ἐπιφάνειαν, τοῦ δὲ κατὰ τὴν ἐξ ἀρχῆς θέσιν β̄ᾱδ̄γ̄ εἰς τοῦπισθεν τε μεταπεσὸν καὶ τὴν ἀριστερὰν βλέπον ἐπιφάνειαν.

9 Καὶ φανερόν, ὅτι τὸν ἐκπερισπασμὸν οὐ κατὰ

¹ β̄ε̄ᾱγ̄ F.

² K. and R.: κατειληφὸς F.

³ K. and R.: ἦν F.

⁴ β̄οᾱβ̄γ̄δ̄ F: K. and R. delete β̄ᾱ. It is, however, a mistake for τὸ, which I have introduced into the text.

⁵ *Lex. mil.* § 37, K. and R.: om. F.

⁶ Omitted by K. and R.

⁷ B (margin) C (Salmasius), *Lex. mil.* § 37, K. and R.: περιστρέφων F.

one at a , and the divisions of the force at β will be on the right, and the divisions at a will be on the left; if, then, we make the entire battalion $a\beta\gamma\delta$ quarter-turn to the right, while β holds his position, the line $a\beta$ will occupy the position $\beta\epsilon$ at a right angle with $a\beta$, and the entire unit will be swung to the right into the position $\beta\epsilon\zeta\eta$, occupying a position in advance and facing to the right.

A back-turn is the reversal of the forward-turn to the position the battalion originally held, as to $a\beta\gamma\delta$.

A half-turn is the movement of the battalion by two quarter-turns in the same direction, as $\beta\theta\kappa\lambda$; it proceeds from the first forward-turn position $\beta\epsilon\zeta\eta$, takes a position in advance, and faces to the right, and, if considered from its original position $a\beta\gamma\delta$, it faces to the rear.¹

It is a three-quarter-turn when the battalions move by three quarter-turns in the same direction to the position behind and facing left from the original station, as $\beta\mu\nu\xi$, a position which, considered from $\beta\theta\kappa\lambda$, lies before and faces the right, and considered from the original station $\beta\alpha\delta\gamma$, lies behind and faces the left.²

It is obviously impracticable to revert by a back-

¹ Such an evolution could scarcely ever have been used in actual warfare.

² This evolution must have been confined to the drill-ground, where for purposes of discipline and exercise formations are still taught which find no place in actual battle.

Asclep. x. 6 = Ael. xxv. 7. Asclep. x. 7 = Ael. xxv. 8.
Asclep. x. 8 = Ael. xxv. 9.

³ B (mar in) C (Salmasius), K. and R. : *συνέχων γίνηται* F.

ASCLEPIODOTUS

ἀναστροφὴν ἀποκαθιστάνειν¹ προσήκει—δεησόμεθα γὰρ τριῶν ἀναστροφῶν, ἵνα ἀποκαταστή, τῆς τε ἐπὶ τὸ β̄θ̄κ̄λ καὶ τῆς ἐπὶ τὸ β̄ε̄ξ̄η καὶ ἐτι τῆς ἐπὶ τὸ β̄ᾱδ̄γ,²—ἀλλὰ κατ' ἐπιστροφὴν μίαν τὴν ἐπὶ τὸ δόρυ, δι' ὅτι τὸ β̄ᾱδ̄γ³ τοῦ β̄μ̄ν̄ξ τόπον μὲν ἔχει τὸν ἔμπροσθεν,³ ἐπιφάνειαν δὲ τὴν ἐκ δεξιῶν. καλεῖται δὲ ἢ κατ' ἐπιστροφὴν εἰς τὸ ἐξ ἀρχῆς ἀποκατάστασις⁴ ἐπικατάστασις.

10 Ἡ μὲν οὖν πρώτη ἐπιστροφή καὶ ἡ τρίτη καλουμένη ἐκπερισπασμὸς μοναχῶς ἀποκαθίστανται,⁵ ἡ μὲν κατὰ ἀναστροφὴν μόνως ἢ β̄ε̄ξ̄η, ἡ δὲ κατ' ἐπιστροφὴν μόνως ἢ β̄μ̄ν̄ξ· ἡ δὲ δὴ μέση τούτων ἢ β̄θ̄κ̄λ, ἣν καὶ περισπασμὸν καλοῦμεν, διχῶς ἀποκαθίσταται,⁶ δι' ὅτι ἡ κατὰ ἀναστροφὴν κινήσις αὐτῆς ἴση ἐστὶ τῇ κατ' ἐπιστροφῆν· δύο γὰρ ἀναστροφαῖς ἀποκαταστήσεται τῇ τε εἰς τὸ β̄ε̄ξ̄η καὶ τῇ εἰς τὸ β̄ᾱδ̄γ,⁷ καὶ δύο ἐπιστροφαῖς ἐπικαταστήσεται, τῇ τε εἰς τὸ β̄μ̄ν̄ξ καὶ τῇ εἰς τὸ β̄ᾱδ̄γ.⁸

11 Εἰ δ' ἐπ' ἀσπίδα ποιοίμεθα⁹ τὴν ἐπιστροφὴν, τόπον ἐφέξει τὸ σύνταγμα καὶ οὕτω τὸν ἔμπροσθεν, ἐπιφάνειαν δὲ ἐναντίαν τὴν κατ' ἀριστεράν.¹⁰ μεταταχθὲν γὰρ τὸ ᾱβ̄γ̄δ̄ περὶ μένοντα τὸν ᾱ λοχαγὸν θέσειν ἔξει τὴν¹¹ ᾱο̄π̄ρ̄ κατὰ πρώτην ἐπιστροφῆν, κατὰ δὲ περισπασμὸν τὴν ᾱσ̄τ̄υ,¹² ἐκπερι-

¹ ἀποκαθιστάναι K. and R.

² K. and R.: β̄ᾱγ̄δ̄ F.

³ K. and R.: τὸν ἐμεν (space of three letters) F.

⁴ K. and R.: κατάστασις F.

⁵ K. and R.: μοναχῶ καθίστανται F.

⁶ K. and R.: καθίσταται F.

⁷ β̄ᾱ (erasure of one letter) δ̄γ̄ F.

⁸ The words from καὶ δύο to the end stand thus in F (except τῇ twice), but have fallen out in ABC.

turn from the three-quarter-turn to the original position, for we shall require three back-turns to do this, one to the position $\beta \theta \kappa \lambda$, one to $\beta \epsilon \zeta \eta$, and one to $\beta \alpha \delta \gamma$; but it is practicable by a quarter-turn to the right, because $\beta \alpha \delta \gamma$ occupies a position before $\beta \mu \nu \xi$ and faces to its right. The return by a quarter-turn to the original position is called advance-to-original-position (*epikalastasis*).

Now the first position, the quarter-turn, and the third, called the three-quarter-turn, can be restored to the original position by a single evolution, the first $\beta \epsilon \zeta \eta$, by a single back-turn, the second $\beta \mu \nu \xi$ by a single quarter-turn; but the position between these two, $\beta \theta \kappa \lambda$, which we also call a half-turn, can resume its original station equally well by two evolutions, because its movement by a back-turn equals that by a quarter-turn; since it requires two back-turns to revert to the original position, first to $\beta \epsilon \zeta \eta$ and then to $\beta \alpha \delta \gamma$, and also two quarter-turns to advance to the original position, first to $\beta \mu \nu \xi$ and then to $\beta \alpha \delta \gamma$.

If we should make the quarter-turn to the left, then the battalion will in the same way occupy the position in advance, with its face, however, to the left; since $\alpha \beta \gamma \delta$, by pivoting upon the stationary file-leader α , will by the first quarter-turn take the position $\alpha \sigma \pi \rho$, by the half-turn the position $\alpha \sigma \tau \nu$,

With Asclep. x. 11 *cf.* Ael. xxxiv. 1.

⁹ ποιούμεθα K. and R. ¹⁰ K. and R.: ἀριστερόν F.

¹¹ K. and R.: ὡς τὴν F: ὡς C (Salinasius).

¹² K. and R.: περισπασμόν τινα ᾠτῆ F.

ASCLEPIODOTUS

σπασθεῖσα δὲ τὴν $\bar{\alpha}\bar{\phi}\bar{\chi}\bar{\psi}$ καὶ ἐπικατασταθεῖσα τὴν¹ $\bar{\alpha}\bar{\beta}\bar{\gamma}\bar{\delta}$. ἡ δὲ τῶν ἀποκαταστάσεων² διαφορά ὁμοία ταῖς ἐπὶ δόρυ σοι νοείσθω.

Ταῦτα δὲ γίνεται ὅπότε ἂν οἱ πολέμοι παραφαίνωνται κατὰ πλευρὰν τῆς φάλαγγος.³

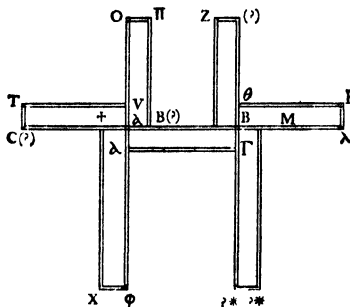

(?) litterae evanid e.

(?)* litterae bibliopegi incuria abscissae (Rostagno).

(In place of this figure which contains some errors and is not easy to understand, K. and R. have substituted two which will be found on the opposite page. On these figures in general see the Introduction.)

- 12 Εἰς ὀρθὸν δὲ ἔστιν ἀποδοῦναι τὸ ἐπὶ τὴν ἐξ ἀρχῆς θέσιν ἀποκαταστήσαι ἄνδρα ἕκαστον ὥστε, εἰ ἐπὶ δόρυ κλίνειν ἐκ τῶν πολεμίων κελεύοντο εἶτα αὖθις ἐπ'⁴ ὀρθὸν ἀποδοῦναι, δεήσει ἐπὶ τοὺς πολεμίους πάλιν τρέπεσθαι.
- 13 Ἐξελιγμὸς⁵ δὲ γίνεται τριχῶς, Μακεδονικός τε

¹ K. and R. : ἐπικαταστάσα τη F.

² K. and R. : καταστάσεων F.

³ A lacuna is assumed here by K. and R. since an explanation of *στοιχεῖν τε καὶ ζυγεῖν* in § 1 above is not given at this point, although an extremely verbose one appears in Arrian and Aelian, *Tactica*, xxvi. 1, in this same relative position.

TACTICS, x. 11 – 13

by the three-quarter-turn the position $a \phi \chi \psi$, and by the advance-to-original-position, the position $a \beta \gamma \delta$. The different ways of returning to the original position you may consider similar to those used in evolutions to the right.

These evolutions are used whenever the enemy appears on a flank of the army.

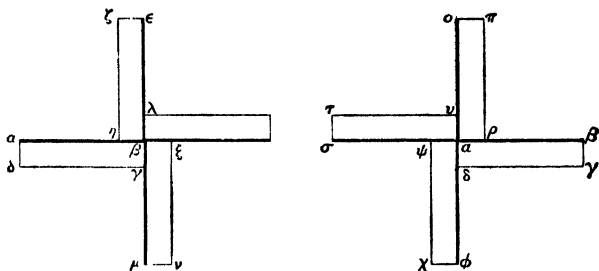

It is called lines-front when man by man the force reverts¹ to its original position, so that in case the command has been given to turn to the right from the enemy and then to form lines-front, the men will have to turn back so as to face the enemy.

There are three types of the counter-march, the

¹ That is, from a turn to the right or to the left.

Asclep. x. 12 = Ael. xxvi. 3.

Asclep. x. 13 = Ael. xxvii. 1-2 ; xxviii. 1.

These terms were defined, however, in ch. ii. 6, above, and, as nothing new is to be added, Asclepiodotus may have been satisfied with that.

⁴ K. and R. suggest *eis* or *és* *óρθόν* which is more natural, is supported by Aelian and Arrian, *Tactica*, xxvi. 3, and *Lex. mil.* § 38, and is perhaps correct.

⁵]*ξελιγμός* (at beginning of a line) F.

ASCLEPIODOTUS

καὶ Λακωνικὸς καὶ ἔτι Κρητικὸς ἦτοι Περσικὸς· τοῦτο δὲ γίνεται διχῶς, ἢ κατὰ στοιχόν ἢ κατὰ ζυγόν.¹

Μακεδονικὸς μὲν οὖν ἐστὶν ἐξελιγμός, ὅτ' ἂν τοῦ λοχαγοῦντος ζυγοῦ τὸν οἰκείον τόπον ἐπέχοντος τὰ ὀπίσω ζυγὰ τὸν ἔμπροσθεν καταλάβῃ τόπον² μεθισταμένων μέχρις οὐραγοῦ, εἶτα κατ' ἄνδρα μεταβαλλόντων· οἶον εἰ τοῦ $\alpha\beta\gamma\delta\epsilon^3$ ζυγοῦ λοχαγοῦντος καὶ μένοντος ἐπὶ ταυτοῦ τὰ εἰς τοῦπίσω τὸ⁴ $\zeta\eta\theta\iota\kappa$ καὶ τὸ $\lambda\mu\nu\xi\omicron$ εἰς τὸ πρόσω καθίστηται, ἦτοι κατὰ ζυγόν, ὥστε τὸ $\zeta\eta\theta\iota\kappa$ μεταστῆναι πρότερον καὶ γενέσθαι κατὰ⁵ τὸ $\pi\rho\sigma\tau\upsilon$, ἔπειτα τὸ $\lambda\mu\nu\xi\omicron$ κατὰ τὸ $\phi\chi\psi\omega\bar{\varsigma}$, ἢ κατὰ στοιχόν, ὥστε τὰ μὲν $\kappa\omicron$ γενέσθαι κατὰ τὰ $\upsilon\bar{\varsigma}$, τὰ δὲ $\iota\bar{\xi}$ κατὰ τὰ $\tau\bar{\omega}^6$ καὶ τὰ⁷ $\acute{\epsilon}\zeta\eta\varsigma$, οἶον τὰ $\theta\upsilon$ κατὰ τὰ $\sigma\psi$ καὶ τὰ⁸ $\eta\mu$ κατὰ τὰ $\rho\chi$ καὶ τὰ⁹ $\zeta\lambda^{10}$ κατὰ τὰ $\pi\phi$. εἶτα καὶ κατ' ἄνδρα μεταβάλωσιν ἀπὸ οὐραγοῦ, τόδε¹¹ ἐστὶν ἀπεστράφθαι μὲν τὰ $\pi\rho\sigma\tau\upsilon$ καὶ τὰ $\phi\chi\psi\omega$ ¹² μέρη, βλέπειν δὲ κατὰ τὰ $\alpha\beta\gamma\delta\epsilon$ διὰ τὸ ὅπιθεν ὀφθῆναι τοὺς πολεμίους. φανερόν δὲ ὅτι κατὰ τοῦτον τὸν ἐξελιγμὸν ἢ φάλαγξ δόξειεν ἂν ὑποχωρεῖν τοῦ οἰκείου τόπου καὶ φυγῇ παραπλήσιον ποιεῖν, ὃ δὴ θαρραλεωτέρους μὲν ποιεῖ τοὺς πολεμίους, ἀσθενεστέρους δὲ τοὺς ἐξελίσσοντας.

14 Ὁ δὲ Λακωνικὸς ἐξελιγμὸς τὸν ἐναντίον τούτῳ

¹ This whole sentence beginning with *τοῦτο δὲ* does not appear here in F, where, as K. and R. saw, it belongs, but between the words *τόπον* and *μεθισταμένων* in the middle of the next sentence.

² See preceding note.

³ K. and R. : $\alpha\beta \bar{\gamma}\delta$ F.

⁴ K. and R. : *τουπίσω* τς F.

⁵ K. and R. : *μετὰ* F.

⁶ K. and R. : $\zeta\omega$ F.

⁷ C (Salmasius), K. and R. : *κατὰ* F.

⁸ K. and R. : *κατὰ* F.

Macedonian, the Laconian, and also the Cretan or Persian; and each of these, again, is performed in two ways, either by file or by rank.¹

It is a Macedonian counter-march when the rank of file-leaders holds its original position, and the rear ranks down to the file-closers march through to a forward position and then each man about-faces; thus $\alpha\beta\gamma\delta\epsilon$ is the rank of file-leaders and remains in the same place, and the back ranks $\zeta\eta\theta\iota\kappa$ and $\lambda\mu\nu\xi\omicron$ move forward, either by rank so that $\zeta\eta\theta\iota\kappa$ marches through first and becomes $\pi\rho\sigma\tau\nu$ and $\lambda\mu\nu\xi\omicron$ becomes $\phi\chi\psi\omega\varsigma$, or by file so that $\kappa\omicron$ takes the place of $\nu\varsigma$, $\iota\xi$ of $\tau\omega$, and so on, as $\theta\nu$ of $\sigma\psi$, $\eta\mu$ of $\rho\chi$, and $\zeta\lambda$ of $\pi\phi$; and then each man from the file-closer on about-faces, *i.e.*, $\pi\rho\sigma\tau\nu$ and $\phi\chi\psi\omega\varsigma$ turn about and face with $\alpha\beta\gamma\delta\epsilon$ as their front line, because the enemy was seen in the rear.² It is clear that in this kind of counter-march the phalanx would seem to yield ground and to be almost in flight, which emboldens the enemy and disheartens those who are counter-marching.

The Laconian counter-march takes up a position

¹ The importance of the counter-march by files is evident, when one bears in mind that in the front lines of the ancient phalanx were stationed the best soldiers (*cf.* iii. 5-6).

² The following diagram will explain this manœuvre:

$$\begin{array}{c} \phi\chi\psi\omega\varsigma \\ \pi\rho\sigma\tau\nu \\ \alpha\beta\gamma\delta\epsilon \\ \zeta\eta\theta\iota\kappa \\ \lambda\mu\nu\xi\omicron \end{array}$$

Asclep. x. 14 = Ael. xxvii. 3; xxviii. 2; *cf.* xxxiv. 4.

⁹ Supplied by C (Salmasius), K. and R.

¹⁰ K. and R.: $\lambda\bar{z}$ F. ¹¹ $\tau\acute{\alpha}\delta\epsilon$ K. and R.: $\tau\acute{\omicron}\delta\delta\acute{\epsilon}$ F.

¹² The additions were made by K. and R.: $\mu\acute{\epsilon}\nu\tau\acute{\alpha}\phi\chi\psi$ F.

ASCLEPIODOTUS

μεταλαμβάνει τόπον· μεταβάλλει γὰρ ἕκαστος ἐπ' οὐρανόν, μένοντος τοῦ οὐραγοῦντος ζυγοῦ οἶον τοῦ ἁμῦξῶ· τὰ γὰρ λοιπά, τό τε ζῆθῖκ καὶ τὸ ἁβῖδῆ μεθίσταται ἐφ' ἑκάτερα . . .¹ τοῦ οὐραγοῦντος, διχῶς δῆλον ὅτι, ἤτοι κατὰ στοῖχον ἢ κατὰ ζυγόν, καὶ θέσιν ἔχει τὸ μὲν ζῆθῖκ² τὴν τοῦ ΖΗΘΙΚ,³ τὸ δὲ ἁβῖδῆ³ τὴν τοῦ ΑΒΓΔΕ.³ τοῦτο δὴ ποιῶν ὁ Λακωνικὸς ἐξελιγμὸς τὴν ἐναντίαν κατὰ τὸν Μακεδονικὸν τοῖς πολεμίοις παρέχεται δόξαν· ἐφορμῶν γὰρ καὶ ἐπιέναι δόξειεν ἂν ὄπιθεν παραφανείσιν, ὥστε καταπλήξαι αὐτοὺς⁴ καὶ δειλίαν ἐκ τοῦδε γενέσθαι.

- 15 Ὁ Κρητικὸς δὲ καὶ Περσικὸς καλούμενος μέσος ἐστὶν ἀμφοῖν· οὐ γὰρ τὸν ὄπιθεν τῆς φάλαγγος μεταλαμβάνει τόπον, ὡς ὁ Μακεδονικὸς, οὔτε τὸν ἔμπροσθεν, ὡς ὁ Λακωνικὸς, ἀλλ' ἐπὶ τοῦ

Φ	Χ	†	Ω	<
Π	Ρ	Σ	Τ	Υ
Α	Β	Γ	Δ	Ε
Ζ	Η	Θ	Ι	Κ
Λ	Μ	Ν	Ξ	Ο

Ζ Η Θ Ι Κ

Α ? Γ Δ ?

† litterae evanidae (Bost. 12110)

αὐτοῦ χωρίου ὁ μὲν λοχαγὸς τοῦ οὐραγοῦ τὸν τόπον⁵ μεταλαμβάνει καὶ οἱ κατὰ τὸ ἐξῆς ἐπι-
304

TACTICS, x. 14 – 15

the opposite of that shown above; for each soldier about-faces to the rear, while the rank of file-closers $\lambda \mu \nu \xi \omicron$ holds its position; and the other ranks $\zeta \eta \theta \iota \kappa$ and $\alpha \beta \gamma \delta \epsilon$ march through on either side [to a position behind the] file-closer—and this, clearly, in two ways, either by file or by rank—and $\zeta \eta \theta \iota \kappa$ take the position Z H Θ I K, and $\alpha \beta \gamma \delta \epsilon$ the position A B Γ Δ E.¹ By this form of manœuvre the Laconian counter-march arouses a feeling in the enemy just opposite to that aroused by the Macedonian; for they would seem to those who have appeared in the rear to be making for and charging upon them, so that they dismay the enemy and arouse fear among them.

The so-called Cretan and Persian counter-march is an intermediate between these two; for it does not occupy the position behind the phalanx, as the Macedonian, nor the one before the phalanx, as the Laconian, but occupies the same ground, while the file-leader takes the place of the file-closer, and in like manner the rear-rank-men those of the front-

¹ To explain the manœuvre :

α	β	γ	δ	ϵ
ζ	η	θ	ι	κ
λ	μ	ν	ξ	\omicron
Z	H	Θ	I	K
A	B	Γ	Δ	E

Asclep. x. 15 = Ael. xxvii. 4; xxviii. 3; cf. xxxiv. 5.

¹ For the lacuna which K. and R. recognized at this point they suggest *παρόντα εἰς τὸν δπιθεν τόπον.*

² K. and R. : $\overline{\zeta\eta\theta\iota\kappa}$ F.

³ K. and R. : $\overline{\alpha\beta\gamma\delta\epsilon}$ F.

⁴ K. and R. : *αὐτοῖς* F.

⁵ K. and R. : *τομέν* F.

ASCLEPIODOTUS

στάται καὶ πρωτοστάται¹ καὶ . . .² παραπο-
 ρευόμενοι κἀνταῦθα διχῶς ἢ³ κατὰ λόχον ἢ κατὰ
 ζυγόν, ἄχρισ ἂν ὁ οὐραγὸς τὸν τοῦ λοχαγοῦ τρόπον
 ἀντιμετάλαβη, ὡς λοχαγοῦντος τοῦ ἁβγδῆ⁴ καὶ
 ἐξῆς ἐπιστατοῦντος⁵ τοῦ ζῆθῖκ καὶ ἐφ' ἐξῆς τοῦ
 λμνξῶ, καὶ μετὰ τοῦτο τοῦ πῤῥῥῥῥ—ἔστω δὲ τοῦτο
 οὐραγοῦν—ὅτ' ἂν τὸ μὲν ἁβγδῆ τὸν τοῦ πῤῥῥῥ
 τρόπον μεταλαμβάνη, τὸ δὲ ζῆθῖκ τὸν τοῦ λμνξῶ,
 τὸ δὲ λμνξῶ τὸν τοῦ ζῆθῖκ, τὸ δὲ πῤῥῥῥ τὸν τοῦ
 ἁβγδῆ. οὕτω γὰρ ὁ ἐξελιγμὸς οὐκ ἀποστήσει
 τοῦ αὐτοῦ χωρίου τὴν φάλαγγα, ὅπερ ἡμῖν ἔσται
 χρήσιμον, ὅπότ' ἂν ὦσιν οἱ ἐκατέρωθεν τόποι
 φαυλότεροι.

- 16 Γίνονται δὲ κατὰ ζυγὸν ἐξελιγμοί, ὅτ' ἂν τὰ
 κέρατα μεθίστηται τῶν ἀποτομῶν· διὰ ταῦτα⁶
 γὰρ ἰσχυρὰ ποιεῖται⁷ τὰ μέσα τῆς φάλαγγος.
 ἐνίοτε δὲ κατὰ ἀποτομᾶς οὐκ ἐγχωρεῖ τοὺς
 ἐξελιγμοὺς ποιήσασθαι, ὅτ' ἂν ἐγγὺς ὦσιν οἱ
 πολέμοιοι, ἀλλὰ κατὰ σύνταγμα, ὥστε τὸ τοῦ
 συντάγματος δεξιὸν ἀντιμεταλαμβάνειν τὰ λαῖα
 καὶ ἀνάπαλιν.⁸

¹ K. and R.: προστάται F.

² For the lacuna which K. and R. recognize at this point they suggest πρωτοστάται ὡς αὐτως τὸν τρόπον ἐφεξῆς μεταλαμβάνουσι παραπορευόμενοι, but, since the actual words are uncertain, they leave καὶ in the text.

³ Supplied by K. and R.

⁴ K. and R.: ἁβγδ F.

⁵ C (Salmassius), K. and R.: ἐξησατος F.

⁶ K. and R.: διὰ τῶν ἀποτόμων ταύταις F.

⁷ ἰσχυροποιεῖται C (Salmassius), K. and R.

⁸ K. and R.: τὸν τοῦ δεξιῦ συντάγματος ἀντιμεταλαμβάνειν τὰ λαῖα καὶ ἀνὰ πᾶσιν F. C (Salmassius) wrote in the margin καὶ τὸν λαῖον τὰ δεξιὰ, which would require τὸν δεξιὸν τοῦ συντάγματος above.

rank-men . . . marching past each other, and this in two ways, either by file or by rank, until the file-closer has in turn taken the place of the file-leader. That is, consider the line of file-leaders $\alpha\beta\gamma\delta\epsilon$, of rear-rank-men $\zeta\eta\theta\iota\kappa$, then $\lambda\mu\nu\xi\omicron$, and after it as the rank of file-closers $\pi\rho\sigma\tau\nu$; then $\alpha\beta\gamma\delta\epsilon$ takes the position of $\pi\rho\sigma\tau\nu$, $\zeta\eta\theta\iota\kappa$ of $\lambda\mu\nu\xi\omicron$, $\lambda\mu\nu\xi\omicron$ that of $\zeta\eta\theta\iota\kappa$, and $\pi\rho\sigma\tau\nu$ that of $\alpha\beta\gamma\delta\epsilon$.¹ By this counter-march the phalanx will not change its ground, and this we shall find advantageous, whenever the terrain before and behind is less favourable.

Counter-marches are made by rank, when the half-wings exchange positions each within its own wing,² for this strengthens the centre of the phalanx. Sometimes it is not advisable to make the counter-marches by half-wings, when the enemy is near by, but rather by battalions, so that the right wing of the battalion occupies the left and *vice versa*.

¹ Cf. the diagram :

α	β	γ	δ	ϵ
●	●	●	●	●
π	μ	σ	τ	ν
ζ	η	θ	ι	κ
●	●	●	●	●
λ	μ	ν	ξ	\omicron
●	●	●	●	●
λ	μ	ν	ξ	\omicron
●	●	●	●	●
ζ	η	θ	ι	κ
●	●	●	●	●
π	ρ	σ	τ	ν
●	●	●	●	●
α	β	γ	δ	ϵ

² Since the strongest half-wing occupies the right flank, the second strongest the left, and the others the centre, by this evolution the two stronger half-wings will exchange places with the two weaker, and so the centre will be strengthened and the wings weakened.

Asclep. x. 16 = Ael. xxvii. 5 ; xxviii. 4.

ASCLEPIODOTUS

Α	Β	Γ	Δ	Ε
Ζ	Η	Θ	Ι	Κ
Λ	Μ	Ν	Ξ	Ο
Π	Ρ	Σ	Τ	Υ

- 17 Διπλασιάσαι δὲ λέγεται διχῶς· ἢ γὰρ τόπον, ἐν ᾧ ἡ φάλαγξ, μένοντος τοῦ πλήθους τῶν ἀνδρῶν, ἢ τὸν ἀριθμὸν αὐτῶν· γίνεται δὲ ἐκάτερον διχῶς κατὰ λόχον ἢ κατὰ ζυγόν, ταῦτόν δὲ εἰπεῖν κατὰ βάθος ἢ κατὰ μῆκος. κατὰ μῆκος μὲν οὖν γίνεται διπλασιασμός ἀνδρῶν, ὅτ' ἂν μεταξὺ τῶν προὔπαρχόντων λόχων παρεμβάλωμεν ἢ παρεμπλέκωμεν ἄλλους αὐτοῖς¹ ἰσαριθμούς τὸ μῆκος τῆς φάλαγγος φυλάττοντες, ὥστε πύκνωσιν γενέσθαι μόνην ἐκ τῆς τῶν ἀνδρῶν διπλασιάσεως· κατὰ βάθος δέ, ὅτ' ἂν μεταξὺ τῶν προὔπαρχόντων ζυγῶν ἄλλα αὐτοῖς ἰσάριθμα παρεμβάλωμεν² ὥστε κατὰ βάθος εἶναι πύκνωσιν μόνην· τί δὲ διενήνοχε παρεμβολὴ παρεμπλοκῆς, εἴρηται πρότερον.
- 18 Τόπου δὲ γίνεται διπλασιασμός κατὰ μῆκος μὲν, ὅτ' ἂν τὴν προειρημένην κατὰ μῆκος πύκνωσιν μανότητι μετατάττωμεν, ἢ³ οἱ παρεντεθέντες⁴ ἐξελίξωσι κατὰ μῆκος πρὸς⁵ τὸ μῆ⁵ ὑπερκερασθῆναι ὑπὸ τῶν πολεμίων ἢ⁵ ὅτ' ἂν ὑπερκεράσαι βουλώμεθα τοὺς πολεμίους· τὸ δ' ὑπερκεράσαι ἐστὶν τὸ τῶ⁵

¹ ἄλλους αὐτοῖς *Lex. mil.* § 40 (*cf.* below ἄλλα αὐτοῖς), K. and R. (in note, ἄλλους alone in text): ἀλλήλους F.

² K. and R. after C (Salmasius), which, however, omits αὐτοῖς: προὔπαρχόντων ἄλλα αὐτοῖς ἰσάριθμα ὥστε F.: *Lex. mil.* § 40 reads παρεμβάλωμεν ἢ παρεμπλέκωμεν ἄλλα αὐτοῖς κτλ.

The term doubling is used in two ways : either of the place occupied by the phalanx, while the number of the men remains the same, or of the number of the men ; and each of these may be by file or by rank, also called by depth or by length. Doubling of men, then, takes place by length when we interject or insert between the original files other files of equal strength, maintaining all the while the length of the phalanx, so that a compact order arises only from the doubling of the men ; doubling takes place by depth when we interject between the original ranks others of equal strength, so that a compact order arises only by depth. The difference between insertion and interjection has been explained before.¹

Doubling of place occurs by length when we change the above mentioned compact formation by length into a loose formation, or when the interjected men counter-march by rank, either to prevent being outflanked by the enemy or when we wish to outflank the enemy ; by outflanking is understood

¹ Cf. vi. 1, where, however, a slightly different word is used for 'insertion.'

Asclep. x. 17=Ael. xxix. 1 ; 2 ; 8.

Asclep. x. 18=xxix. 7 ; 9 ; xxxviii. 1-2.

³ *μανοτη μεταταπτομένη* οί F.

⁴ *παρεντιθεντες* F : *παρεντεθέντες* *Lex. mil.* § 40.

⁵ Thus have K. and R. reconstructed the confused passage which runs in F: *κατὰ μῆκος. τοῦτο δὲ γίνεται δι' ἂν ὑπερκεράσαι βουλόμεθα τοὺς πολεμίους. τὸ δ' ὑπερκεράσαι ἐστὶν τὸ τῷ κέρατι ὑπερβαλέσθαι τὸ ἐκείνων κέρας τοῦ ἑτέρου' ἐνίσσε καὶ ἐλλίποντος διολιγύττητα ἀνδρῶν . . . 19 . . . ἐξελιξωσι κατὰ βάθος πρὸς τὸ ὑπερκερασθῆναι ὑπὸ τῶν πολεμίων.*

ASCLEPIODOTUS

κέρατι τῷ ἐτέρῳ¹ ὑπερβαλέσθαι τὸ ἐκείνων κέρας¹—
τοῦτο¹ δὲ γίνεται¹ ἐνίοτε καὶ τοῦ ἐτέρου¹ ἐλλεί-
ποντος¹ δι' ὀλιγότητα¹ ἀνδρῶν, ὡς, ὅτ' ἂν γε καθ'
ἐκάτερον κέρας ὑπερβάλλωσιν, ὑπερφαλαγγεῖν²
λέγεται.

- 19 Κατὰ βάθος δὲ γίνεται τόπου διπλασιασμός,
ὅτ' ἂν τὴν προειρημένην κατὰ βάθος πύκνωσιν
μανότητι μετατάττομεν ἢ³ οἱ παρεντεθέντες⁴ ἐξ-
ελίξωσι κατὰ βάθος.¹
- 20 Ἀποκαταστήσαι δὲ ὅτ' ἂν βουλόμεθα ἐπὶ τὰ⁵
ἐξ ἀρχῆς, παραγγελοῦμεν ἐξελίσσειν τοὺς μετα-
τεταγμένους εἰς οὓς προεῖχον τόπους. ἔνιοι δὲ
τοὺς τοιούτους διπλασιασμοὺς ἀποδοκιμάζουσιν
καὶ μάλιστα ἐγγὺς ὄντων τῶν πολεμίων, ἐφ'
ἐκάτερα δὲ τῶν κεράτων τοὺς ψιλοὺς καὶ τοὺς
ἰππέας ἐπεκτείνοντες τὴν⁶ ὄψιν τοῦ⁷ διπλασιασμοῦ
χωρὶς παραχῆς τῆς φάλαγγος ἀποδιδόασιν.
- 21 Γίνεται δὲ ἐκ τῶν τοιούτων σχηματισμῶν
φάλαγξ τοτὲ μὲν τετράγωνος, τοτὲ δὲ παραμήκης
καὶ ἦτοι πλαγία, ὅτ' ἂν τὸ μῆκος τοῦ βάθους
πολλαπλάσιον ἦ,⁸ ἢ⁹ ὀρθία ὅτ' ἂν ἀνάπαλιν τὸ
βάθος τοῦ μήκους· τούτων δ' ἀνὰ μέσον ἡ λοξή,¹⁰
ἢ¹¹ θάτερον κέρας πλησίον ἔχουσα τῶν πολεμίων
καὶ ἐν αὐτῷ τὸν ἀγῶνα ποιουμένη, θάτερον¹¹ δ' ἐν

¹ See note 5 on p. 309.

² C (Salmasius)? K. and R.: ὑπερφαλαγγιν F.

³ μανοτητι μεταταττομενη οἱ F. ⁴ παρεντιθέντες F.

⁵ C (Salmasius), K. and R.: ἔπειτα F.

⁶ C (Salmasius), K. and R.: ἡ ἐκτείνοντες F.

⁷ K. and R. (B? C?): ἡ τοῦ F.

⁸ Added by K. and R.

⁹ Added by C (Salmasius)? K. and R. ¹⁰ λοχη F.

¹¹ K. and R.: καὶ F.

the throwing of one wing about the wing of the enemy—and this is done sometimes even when a wing is numerically inferior to that of the enemy—as when both wings are used in a flanking movement, it is called a double outflanking.

Doubling of place is performed by depth when we change the above mentioned compact formation by depth into a loose formation, or when the interjected men counter-march by file.

Whenever we wish to return this compact formation to its original position, we shall command the men who have changed their position to counter-march to their original stations. Some condemn such doublings, especially when the enemy is near, and, by extending the light infantry and cavalry on both wings, give the appearance of the doubling without disturbing the phalanx.

By such evolutions a phalanx assumes the form sometimes of a square, sometimes of an oblong rectangle, or, again, of an extended front when the length is many times as great as the depth, or of an extended depth when the depth is many times as great as the length; an oblique front lies midway between the last two. In this formation one wing is drawn up close to the enemy and fights the contest, while the other is partly withdrawn and refused;

Asclep. x. 19=Ael. xxix. 9.

Asclep. x. 20=Ael. xxix. 3; 5; 6; 10.

Asclep. x. 21=Ael. xxx.

ASCLEPIODOTUS

ἀποστάσει δι' ὑποστολῆς¹ ἔχουσα, δεξιὰ μὲν ἡ²
τὸ δεξιὸν³ προβεβλημένη, λαϊὰ δὲ ἡ τὸ λαϊόν.⁴

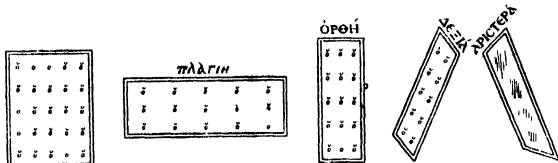

* hic litterarum vestigia sunt tam evanida, ut quid legeretur scriptum deprehendi non possit.

** quid pictum esset in tabulis ἀριστερά inscripta non patet (Rostagno)

- 22 Πολλὰ δὲ καὶ ἄλλα σχήματα οὐ μόνον ἐν ταῖς μάχαις, ἀλλὰ καὶ ταῖς πορείαις ἴσχει πρὸς τὰς ἐξαιφνης τῶν πολεμίων ἐφόδους· καταδιαίρειται γὰρ εἰς τὰ μέρη τοτὲ μὲν τὰ μείζω, τοτὲ δὲ τὰ ἐλάττω, ὡς κέρατα καὶ ἀποτομάς, ὥστ' ἐν τῇ συζεύξει τὰς μοίρας τοτὲ μὲν ἀντιστόμους γενέσθαι, τοτὲ δὲ ἀμφιστόμους, ἄλλοτε δὲ ὁμοιοστόμους ἢ ἑτεροστόμους.

Ἡ γὰρ ἐξ ἑνὸς μέρους ὑφορῶνται τοὺς πολεμίους ἢ ἐκ δυεῖν⁵ ἢ τριῶν ἢ πανταχόθεν, περὶ ὧν ἐξῆς εἴρηται.

XI. Περὶ πορείων

Παραγωγή καλεῖται ἡ τῆς φάλαγγος ἥτοι καθ' ὅλην ἢ κατὰ μέρη καί, εἰ καθ' ὅλην, ἡ⁶ πλαγία λέγεται, ὅτ' ἂν κατὰ τὴν πλαγίαν θέσιν βαδίζῃ, ἢ ὀρθία, ὅτ' ἂν κατὰ τὴν ὀρθίαν· καὶ εἰ πλαγία πορεύοιτο, ἥτοι κατ' ὀρθόν,⁷ ὅτ' ἂν κατὰ τοὺς

¹ K. and R.: δι' ὑποστολῆν F.

² K. and R. (in mss. ?): ἡ F.

³ K. and R.: τὰ δεξιὰ F.

⁴ A lacuna is perhaps to be assumed here since an explanation of παρεμβολή, παρένθεσις, πρόταξις, ὑπόταξις, and

it is called the right oblique when the right wing is advanced, and the left oblique when the left wing is advanced.¹

Many other formations are in use, not merely in battle, but also on the march to guard against the sudden attacks of the enemy; for the entire army is broken up into its parts, sometimes large and sometimes small, such as wings and half-wings, so that when the parts are combined the army may face the enemy with inner fronts or with outer fronts, and at other times with corresponding or again with different fronts.

For the enemy is descried either on one side, or on two, or three, or on all sides. Each of these situations has been discussed in order.

XI. *Formations in Marching*

A march in line (*paragoge*) is the march of the phalanx, either as a whole or by its parts; as a whole, it is called either a march by front when it advances with extended front, or a march by file when it advances in file. And if it march with an extended front it is either forward by the rank of file-

¹ The figures to explain these formations will be found below: square (Fig. 21), extended front (Figs. 1 and 2), extended depth (Figs. 3 and 4), right oblique (Fig. 6), and left oblique (Fig. 5).

With Asclep. x. 22 *cf.* Ael. xxiv. 1.

With Asclep. xi. 1-2 *cf.* Ael. xxxvi.

ἐπιταξίς in § 1 above is not given; but the first four terms are defined in vi. 1, and *ἐπιταξίς* is clear from the definition of *ἐπιταγμα* in vii. 10, so that Asclepiodotus himself may have omitted the definitions here.

⁶ C (Salmاسius), K. and R.: *ἡκαχελυη* F.

⁶ K. and R. (ABC?): *ἡ* F.

⁷ K. and R.: *κατορθόν* F.

ASCLEPIODOTUS

λοχαγούς, ἢ ἐπ' οὐράν, ὅτ' ἂν κατὰ τοὺς οὐραγούς· ὀρθία δὲ εἰ φέροίτο καὶ τὸ λοχαγούν ζυγόν, ὃ δὴ καὶ στόμα λέγεται, δεξιὸν ἔχει¹, δεξιὰ καλεῖται, εἰ δὲ λαιόν, ἀριστερά· λοξὴ δὲ ὡς αὐτῶς λαιά τε καὶ δεξιὰ ἢ τὸ προῦχον² ἔχουσα κέρασ ὁμώνυμον, κυρτὴ δὲ καὶ κοίλη καὶ ἐπικάμπιος εἰς τοῦπίσω ἢ³ καὶ πρόσω ἢ τὸ στόμα κοῖλον ἢ κυρτὸν ἢ εἰς τοῦπίσω ἢ καὶ πρόσω ἐπικεκαμμένον³ ἔχουσα, ὡς ἔχει τὰ ὑπογεγραμμένα.

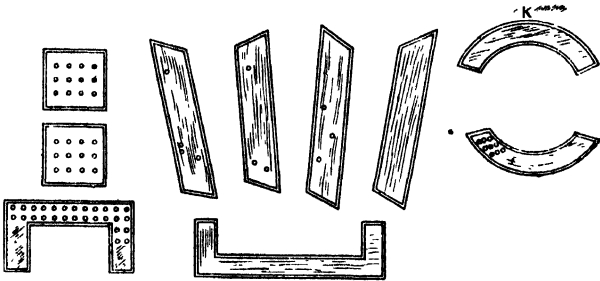

Omnia sunt tam evanida, ut aeiem oculorum pentus effugiant (Rostagno).⁴

¹ ἔχει K. and R.

² K. and R. : προῦχον F.

³ K. and R. from the inscriptions on the accompanying diagrams. F has only τοῦπίσω δὲ καὶ πρόσω τὸ στόμα κοῖλον ἢ κυρτὸν ἢ ἐπικεκαμμένον.

⁴ In ABC the following inscriptions, which must have stood at one time in F, as there are still faint traces, especially above Fig. 7 where κ of κυρτὴ is still legible, are attached to the illustrations: πλαγία κατευθείαν (l. πλαγία κατ' ὀρθόν), πλαγία (l. πλαγία) ἐπ' οὐράν, ὀρθία δεξιὰ, ὀρθία ἀριστερά, ἀριστερά (l. λοξὴ ἀριστερά), δεξιὰ (l. λοξὴ δεξιὰ), κυρτὴ, κοίλη, ἐπικάμπιος ὀπίσω, ἐπικάμπιος πρόσω. These figures have been reconstructed by K. and R. and in that form are reproduced on the opposite page.

TACTICS, XI. 1

leaders (Fig. 1), or backward by the rank of file-closers (Fig. 2); but if it move in column, if the line of file-leaders, which is also called the mouth, is on the right, it is called by the right (Fig. 3), and if on the left, it is called by the left (Fig. 4); also a left (Fig. 5) and right (Fig. 6) oblique march-in-line when the corresponding wing is advanced; a convex (Fig. 7), concave¹ (Fig. 8), and a half-square march backwards (Fig. 9) and the same forward (Fig. 10), when the front is bent concave, convex, or as a half-square forward or backward, as in the following diagrams.²

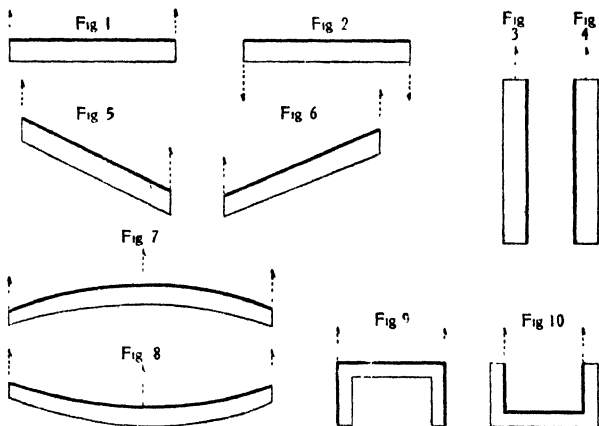

¹ Most unusual formations, certainly, for marching.

² The treatment of this and the following paragraphs in Aelian is very different.

ASCLEPIODOTUS

2 Τὸ δ' ὄρθιον¹ τοῦτο καὶ πλάγιον οὐ μόνον ἐπὶ τῆς ὄλης φάλαγγος ἐκδέχεσθαι δεῖ,² ἀλλὰ γὰρ³ καὶ ἐπὶ τῶν μερῶν· εἰ γὰρ⁴ κατὰ κέρατα βαδίζου ἢ φάλαγξ, ἢ κατ' ὄρθια⁵ ἢ πλάγια, καί, εἴτε κατ' ὄρθια εἴτε⁶ πλάγια, ἢ κατ' ἐπαγωγὴν ἦτοι σύζευξιν· ἔστι δὲ κατ' ἐπαγωγὴν μὲν, ὅτ' ἂν τὸ δεύτερον ἔπηται τῷ προτέρῳ, κατὰ σύζευξιν δέ, ὅτ' ἂν μηδ' ἕτερον θάτερον προηγῆται.

3 Τοῦ δ' ὀρθίου⁷ κατὰ σύζευξιν εἶδη τέσσαρα· ἢ γὰρ δεξιά ἐστὶν ἄμφω τὰ στόματα⁸ ἢ λαιὰ καὶ καλεῖται ἢ φάλαγξ⁹ ὁμοίοστομος, ἢ μὲν δεξιά, ἢ δὲ λαιά, ἢ¹⁰ ἐναντίως ἔχει τὰ στόματα, καὶ εἰ μὲν κατὰ ταῦτα συνάπτοιεν ἀλλήλοισ¹¹, ἀντίστομος ἐπονομάζεται, εἰ δὲ κατὰ τοὺς οὐραγούς, ἀμφίστομος.

4 Τῶν δὲ κατ' ἐπαγωγὴν πορευομένων¹² ποιεῖν ἔστιν ὄρθια ἑτεροστόμως¹³ μόνον, ὥστε¹⁴ τὸ μὲν ἔχει δεξιόν, τὸ δὲ λαιὸν στόμα· οὐ γὰρ οἶόν τε¹⁵ ἐπὶ τὰ αὐτὰ ἔχειν ἄμφω, οὐδὲν γὰρ διοίσει τῆς ὄλης τὰ κέρατα, δι¹⁶ ὃ καὶ τὰ πλάγια οὕτως μόνον συζευχθήσονται· κατ' ἐπαγωγὴν¹⁸ γὰρ τὰ¹⁷ πλάγια

¹ K. and R. : Τοδ' ὀρθὸν F.

² ἐπιδέχεσθαι χρῆ K. and R. after C (Salmasius), which, however, has χρῆ.

³ K. and R. delete γάρ.

⁴ εἰ γε F.

⁵ K. and R. : βαδίζου ἢ γὰρ κατορθά F.

⁶ K. and R. : καὶ εἰ πλάγια F.

⁷ K. and R. : τοῦ δὲ κατὰ F.

⁸ τὰ στόματα added by K. and R.

⁹ Added by K. and R. (after AB).

¹⁰ K. and R. : εἰ F.

¹¹ C (Salmasius) in margin, K. and R. : εἰλη F.

¹² K. and R. : δετεπαγωγὴν ορευομένων F. As K. and R. suggest, τὰ στόματα is to be understood, if not actually supplied.

¹³ K. and R. : ἐτερόστομος F.

¹⁴ K. and R. : δι' ὅτι F.

TACTICS, xi. 2 - 4

The march by flank¹ and the march by front need apply not merely to the entire phalanx, but also to its parts; for if the phalanx should march by wings, it may be either by column or by front, and each of these again either in sequence (*epagoge*) or in parallel formation (*syzeuxis*); it is a march in sequence when the second wing follows the first, and in parallel formation when neither precedes the other.²

There are four kinds of march in column in parallel formation: for the fronts may be either right or left, which is called the order with corresponding front, right (Fig. 11), or left (Fig. 12); or the fronts may be opposite, and if the men should march with fronts side by side it is called a march with inner fronts (Fig. 13), but if with file-closers side by side a march with outer fronts (Fig. 14).

When the army advances in sequence formation and in column, it can do so only with different fronts, so that one wing has its front right and the other its front left (Fig. 15), it being impossible for the fronts to be on the same side, for the march by wings would then differ in no respect from that of the phalanx in a body,³ since in this way the fronts will follow one behind the other; but when the army advances in

¹ That is, in file, or in column.

² That is, when the wings are side by side.

³ As in Figs. 3 and 4.

Asclep. xi. 3 = Ael. xxxvii. 2; 3; 5.

Asclep. xi. 4 = Ael. xxxvii. 4.

¹⁵ K. and R.: *σιονται* F.

¹⁶ These words, *δι' δ . . . επαγωγῆν*, are supplied by K. and R.

¹⁷ *τὰ γὰρ* F.

ASCLEPIODOTUS

ἢ ὁμοιοστόμωσ' συντεθήσονται¹ ἢ ἀμφιστόμωσ' τοῖσ γὰρ οὐραγοῖσ τοῦ ἡγουμένου τοτὲ μὲν οἱ λοχαγοί, τοτὲ δὲ οἱ οὐραγοί τοῦ ἐπομένου μεταταγήσονται.²

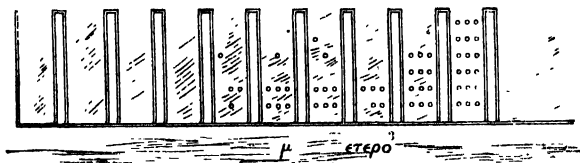

- 5 Καὶ τὰ λοχὰ δὲ συντιθέμενα διττὰσ ἔχουσι διαφοράσ· ἢ γὰρ λαιὸν ἐν λαιῶ τάπτεται μέρει⁴ καὶ δεξιὸν ἐνδεξιῶ καὶ καλεῖται ἢ ὄλη κοιλέμβολοσ, ἢ ἀνάπαλιν καὶ λέγεται ἔμβολοσ, ὡσ τὰ ὑποτεταγμένα σχήματα.

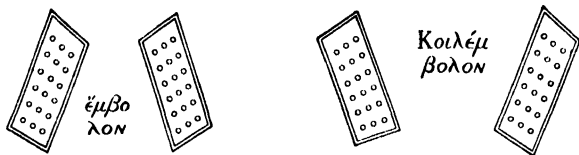

(These figures as reconstructed by K. and R. are given on the opposite page.)

- 6 Ἔστι δ' ὅτε καὶ τετραμερία πορεύονται κατὰ ἀποτομάσ παντοχόθεν φυλαττόμενοι τοὺσ πολεμίουσ καὶ γίνεται τετράπλευρον⁵ περίστομον τοτὲ

¹ K. and R.: *συνεχθήσονται* F, which, though impossible here, supplied the clue to the supplement of K. and R. above.

² K. and R.: *παραταγήσονται* F.

³ In ABC apparently the following inscriptions, which must have been in F, where a few letters of *ἐτερόστομοσ* are still visible, are attached to the illustrations: *δεξιὰ ὁμοίοστομοσ, ἀριστερά ὁμοίοστομοσ, ἀμφίοστομοσ, ἀντίστομοσ, ἐτερόστομοσ.*

sequence formation and with extended front it will have either corresponding fronts or outer fronts, *i.e.*, behind the file-closers of the leading wing will follow either the file-leaders (Fig. 16) or the file-closers (Fig. 17) of the second wing.

The wings also, when in oblique formation, have two different positions: either the left wing is advanced on the left side and the right wing on the right, in which array the entire phalanx is called a hollow-wedge (*koilembolos*, Fig. 18), or just the opposite formation is assumed, when it is called a wedge (*embolos*, Fig. 19); see the following diagrams.

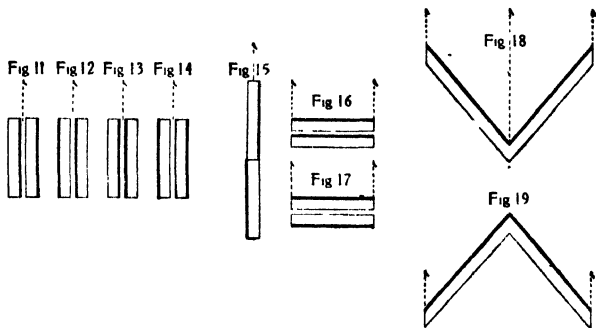

Sometimes the army marches in four parts by divisions, on its guard upon every side against the enemy, and we have a four-sided figure fronting on

Asclep. xi. 5 = Ael. xxxvii. 6-7.

Asclep. xi. 6 = Ael. xxxvii. 8-9.

The figures as reconstructed by K. and R. are given on this page.

⁴ C (Salmasius), K. and R.: *μει ει F.*

⁵ K. and R.: *τετράπλευραν F.*

ASCLEPIODOTUS

μὲν ἑτερόμηκες, τότε δὲ τετράγωνον, πανταχόθεν ἔχον στόματα ὡς τὸ ὑπογεγραμμένον.

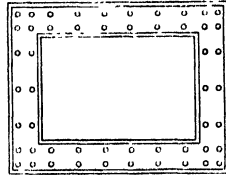
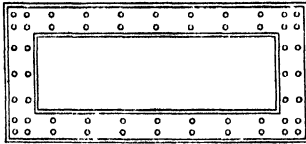

(These figures as reconstructed by K and R are given on the opposite page.)

- 7 Ὅτ' ἂν δὲ κατὰ πλείω μέρη πορεύονται, ἢ ἔσπαρμένα συντάγματα πορεύεται ἢ πεπλεγμένα· πεπλεγμένα δέ¹ ἐστὶν ὅτ' ἂν λοξὰ πορεύηται² ὑοειδῆ³ τὴν ὄλην ποιοῦντα φάλαγγα· ἔσπαρμένα δὲ ὅπότε ἂν κατὰ παραλληλόγραμμα⁴ μόναις ταῖς γωνίαις⁵ συνάπτοντα ἀλλήλοις, ταῖς δὲ πλευραῖς ἐπὶ τὸ πρόσω βλέποντα. καὶ ὁ τούτων δὲ τύπος ἐκ τῆς ὑπογραφῆς ἔσται φανερός·⁶ γένοιτο δ' ἂν κατὰ τὸ εἶκος καὶ ἕτερα σχήματα πρὸς τὰς ἀνακυπτούσας ἀρμόζοντα χρείας.
- 8 Ἀναγκαιοτάτη δ' οὖσα⁷ καὶ ἡ τῶν σκευοφόρων ἀγωγή ἡγεμόνος δεομένη κατὰ τρόπους γίνεται

¹ καὶ πεπλεγμένα μὲν K. and R. who report ABC as having only ἢ πεπλεγμένα δέ. If so F confirms the essential correctness of their reading.

² K. and R.: πορεύεται F.

³ K. and R.: υοειδῆ F. The smooth breathing is etymologically correct and I see no reason to follow the lexicons and introduce the rough.

⁴ παραλληλόγραμμον K. and R. after C (Salmasius).

⁵ K. and R.: γωνίαις F.

⁶ φανερόν K. and R. (apparently from A and B, for the phrase is omitted by C).

⁷ οὖσα F (the ὄ added by the first hand).

each side, an oblong rectangle (Fig. 20) or a square (Fig. 21) which fronts on all sides, as the following diagram shows.¹

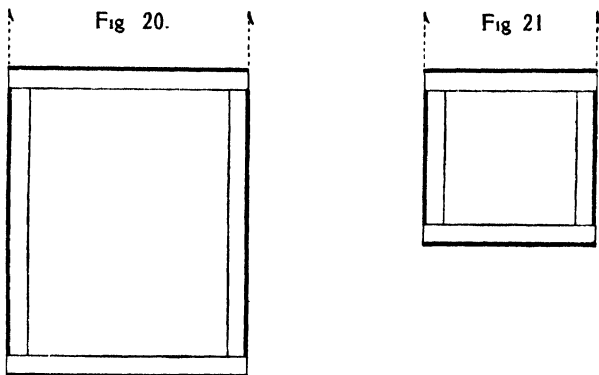

When the army marches in several divisions, the battalions will be either in loose or close formation: it is the close formation when the march is by battalions *en échelon*, the entire phalanx assuming the form of a V (Fig. 22); the loose formation, when the battalions form parallelograms with only the corners touching one another, but with the fronts facing forward (Fig. 23). The form of these dispositions will be clear from the following figure. There might, of course, be other orders of march, meeting the situations that arise.

The baggage-train, which is very essential and requires its own commander, is convoyed in five

¹ The *locus classicus* for this order of march is the *Anabasis* of Xenophon iii. 4. 19-23.

Asclep xi. 7 = Ael. xlvi. 2-3. Asclep xi. 8 = Ael. xxvix.

ASCLEPIODOTUS

πέντε· ἢ γὰρ προάγειν δεῖ τῆς φάλαγγος, ὅτ' ἂν ἐκ πολεμίων ἀπίη,¹ ἢ ἐπακολουθεῖν, ὅτ' ἂν εἰς πολεμίους ἐμβάλλη, ἢ παρὰ τὴν φάλαγγα κατὰ

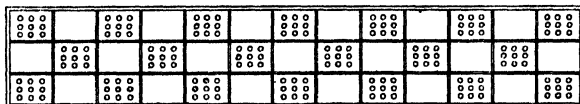

(This figure as reconstructed by K and R. is given on the opposite page.)

λαϊὰ ἢ δεξιὰ εἶναι, ὅπότ' ἂν φοβῆται² τὰναντία μέρη, ἢ τό γε λειπόμενον ἀγόμενα ἐντὸς κοίλη τῆ³ φάλαγγι περιέχεσθαι πανταχόθεν ὄντος τοῦ δέους.

XII. Περὶ τῶν κατὰ τὰς κινήσεις προσταγμάτων

Τοσούτων δὲ ὄντων καὶ τοιούτων σχηματισμῶν ἐπόμενον ἂν εἶη τοῖς περὶ αὐτῶν ἐπιέναι προσταγμασι, καθ' ἃ⁴ σχηματίζειν τε αὐτὰ καὶ κινεῖν δυνασόμεθα καὶ ἀποκαθιστάνειν⁵ εἰς τὴν προϋπάρχουσαν τάξιν. τοῦτο γὰρ ἦν ἔτι λειπόμενον.

- 2 Ὅτ' ἂν μὲν οὖν ἐπὶ δόρυ τὰ συντάγματα ἐπιστρέφειν βουλώμεθα, παραγγελοῦμεν τὸν ἐπὶ τοῦ δεξιοῦ λόχον⁶ ἡσυχίαν ἄγειν, ἕκαστον δὲ τῶν ἐν τοῖς ἄλλοις λόχοις ἐπὶ δόρυ κλῖναι, προσάγειν⁷ τε ἐπὶ τὸ δεξιόν, εἶτα εἰς ὀρθὸν ἀποδοῦναι, ἔπειτα

¹ K. and R.: ἀπίη F.

² K. and R.: φοβεῖται F.

³ K. and R.: ἀγόμενον. ἢ κοίλη τῆ F.

⁴ K. and R.: καθὰ F.

⁵ ἀποκαθιστάναι K. and R.

⁶ K. and R.: λοξὸν F: λοχαγὸν C (Salmasius).

⁷ F (K. and R. had emended to this the form προάγειν in ABC)

¹ The importance of the heavy baggage-train to the
322

ways : it must precede the phalanx when the march is away from the enemy's country, or follow it, when the march is into the enemy's country, or parallel

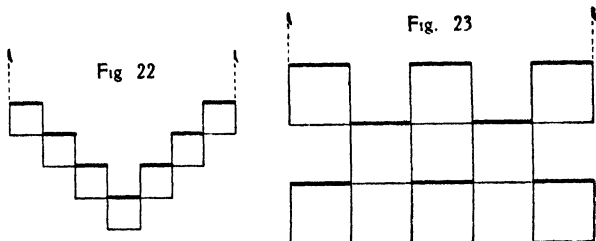

the phalanx on the right or left side, whenever danger is suspected from the opposite side, or, finally, it may be convoyed within the hollow square of the phalanx, when danger threatens on all sides.¹

XII. *The Commands used in military Evolutions*

Such being the number and character of the evolutions, there would naturally follow a discussion of the commands used in these movements, by which we can order and move the troops, and return them to their original station ; for this is the one thing we have left to do.

When, therefore, we wish the battalions to quarter turn to the right, we shall command the right file to hold its position and each man in the rest of the files to right face, to advance to the right, and then to face to the front ; then we shall command

ancient army is hardly appreciated by our author, who dismisses it in these few words.

Asclep. xij. 1-2 = Ael. xxxii. 2.

ASCLEPIODOTUS

- προσάγειν¹ τὰ ὀπίσω ζυγά, καὶ ταύτης γενομένης τῆς πυκνώσεως ἐπιστρέφειν ἐπὶ δόρυ, καὶ ἔσται τὸ σύνταγμα ἐπεστραμμένον.
- 3 Ἐὰν δὲ ἐπὶ τὴν ἐξ ἀρχῆς² θέσιν ἀποκαταστήσαι βουλόμεθα, ἐπ' ἀσπίδα μεταβάλλεσθαι παραγγελοῦμεν— ἢ δὲ μεταβολὴ τί σημαίνει πρότερον εἴρηται—, εἰτ' ἀναστρέφειν ὅλον τὸ σύνταγμα, ἔπειτα ἐξ ἀρχῆς² τῶν λοχαγῶν ἡρεμούντων οἱ λοιποὶ κατὰ ζυγὰ προαγέτωσαν, ἔπειτα μεταβάλλεσθωσαν, ἐφ' ἃ ἐξ ἀρχῆς² ἔνευον· ἔπειτα ὁ δεξιὸς ἡρεμείτω λόχος,³ οἱ δὲ λοιποὶ ἐπ' ἀσπίδα κλινέτωσαν καὶ προάγοντες ἀποκαθιστάθωσαν. οὕτω γὰρ τὴν τάξιν, ἣν πρότερον εἶχεν, ἕκαστος ἀπολήψεται.
- 4 Εἰ δ' ἐπ' ἀσπίδα βουλοίμεθα⁴ ἐπιστρέφειν, παραγγελοῦμεν ἑκάστου συντάγματος τὸν λαιὸν λόχον⁵ ἡρεμείν, τῶν δὲ ἄλλων ἕκαστον ἐπ' ἀσπίδα κλῖναι καὶ προσάγειν¹ εἰς τὰ λαιά, εἶτα εἰς ὀρθὸν ἀποδοῦναι, ἔπειτα προσάγειν¹ τὰ ὀπίσω ζυγά, καὶ γενομένης τῆς πυκνώσεως ἐπ' ἀσπίδα ἐπιστρέφειν περὶ τὸν λαιὸν λοχαγόν, καὶ γέγονε τὸ παραγγελθέν.
- 5 Ἀποκαταστήσαι δὲ βουλόμενοι ἕκαστον μεταβαλοῦμεν, εἶτα σύνταγμα ἀναστρεψιάτω, εἶτα οἱ

¹ F (K. and R. had emended to this the form *προάγειν* in ABC).

² The repetition of the phrase before τῶν λοχαγῶν seems to have no precise meaning and is probably due, as K. and R. suggested, to the appearance of the same phrase at two other places in the paragraph, especially the one just below.

³ λοχαγός (*surpriser*.) C (Salmasius).

⁴ βουλοίμεθα K. and R.

⁵ λοχαγός above λόχος C (Salmasius).

the rear ranks to advance, and, when in this way we have the compact formation, to quarter turn to the right,¹ and the battalion will be swung to the right.

If we wish the battalion to resume the original position, we shall give the command to left about face—the meaning of ‘about face’ has been explained above²—and then for the entire battalion to resume its original position;³ after that, while the rank of file-leaders holds its position, let the other soldiers advance by rank and about face in the direction originally faced; next let the right file hold its position and the rest of the soldiers left face, and advancing wheel to original position. In this manner each man will resume his former place.

If we wish to quarter turn to the left, we shall command the left file of each battalion to hold its position, and the other files to left face, to advance to the left, and then to face to the front; after that we shall command the rear ranks to advance and, when in this way we have the compact formation, to quarter turn to the left on the left file-leader, and the command is carried out.

If we wish the battalions to return to their original position, we shall make each man about face, and each battalion resume its original place; let the

¹ The verb used here, as defined in x. 4, means to ‘pivot on the right file-leader,’ and so the evolution is clear. Cf. the opposite evolution in § 4 below.

² That is, in x. 3.

³ That is, the battalion shall pivot on the right file-closer, who now, because of the about-face, is the left file-leader.

Asclep. xii. 3 = Ael. xxxii. 3. Asclep. xii. 4 = Ael. xxxii. 4.
Asclep. xii. 5 = Ael. xxxii. 5.

ASCLEPIODOTUS

λοχαγοὶ ἡρεμείωσαν, οἱ δὲ λοιποὶ κατὰ ζυγὰ προαγέτωσαν, ἔπειτα μεταβαλλέσθωσαν¹ ἐφ' ἃ ἐξ ἀρχῆς ἔνευον, ἔπειτα² ὁ λαὸς λόχος ἡρεμείω, οἱ δὲ λοιποὶ ἐπὶ δόρυ κλίναντες προαγέτωσαν,³ ἕως ἂν ἀποκαταστῇ τὰ διαστήματα, εἶτα εἰς ὀρθὸν⁴ ἀποδότησαν, καὶ πάντες ἕξουσι τὴν τάξιν ἢν πρότερον εἶχον.

8 Ἐὰν δὲ ἐπὶ δόρυ περισπᾶν βουλόμεθα, δύο ἐπιστροφὰς ἐπὶ τὸ αὐτὸ⁴ ποιῆσαι παραγγελοῦμεν ἀποκαταστῆσαι⁵ δὲ βουλόμενοι παραγγελοῦμεν ἔτι ἐπὶ δόρυ περισπᾶν—ἐκ τεσσάρων γὰρ ἐπιστροφῶν εἰς τὸ αὐτὸ πάλιν ἀποκαθίσταται—, τούτων δὲ γενομένων⁶ ἔτι παραγγελοῦμεν τοὺς λοχαγοὺς ἡρεμεῖν, τοὺς δὲ λοιποὺς μεταβάλλεσθαι⁷ καὶ ἀπιέναι τὰ ὀπίσω ζυγὰ, εἶτα πάλιν⁷ μεταβάλλεσθαι, τὸν δεξιὸν δὲ λόχον ἡρεμεῖν καὶ τοὺς λοιποὺς ἐπ' ἀσπίδα κλίναντες προάγειν καὶ ἀποκαθιστάνειν⁸ εἰς τὸ ἐξ ἀρχῆς διάστημα, εἶτα⁷ εἰς ὀρθὸν ἀποδοῦναι, καὶ οὕτως ἔσται εἰς τὸ ἐξ ἀρχῆς καθεστῶτα.

7 Εἰ δὲ ἐπ' ἀσπίδα βουλόμεθα περισπᾶν, τοῖς ἐναντίοις παραγγελοῦμεν ἐπ' ἀσπίδα δις ἐπιστρέφειν,⁹

¹ The words from μεταβαλλέσθωσαν to ἔπειτα are supplied by K. and R. from the parallel passage in Aelian, *Tactica*, xxxii. 5.

² K. and R.: προσαγέτωσαν F.

³ K. and R.: ὀρθὴν F.

⁴ τοαυτὸ δόρυ F: τὸ αὐτὸ τουτέστιν ἐπὶ δόρυ K. and R. But δόρυ derives probably from a gloss on τὸ αὐτὸ and does not appear in the parallel passage in Aelian, *Tactica*, xxxii. 6.

⁵ K. and R.: παρακαταστῆσαι F.

⁶ The contraction for ομενων is by a much later hand in an erasure of about three letters (Rostagno).

⁷ Supplied by K. and R. from the parallel passage in Aelian, *Tactica*, xxxii. 7.

file-leaders hold their position and the rest advance by rank and about face in the direction originally faced, then let the left file hold its position and the rest right face, advance until the intervals between them are resumed, and then face to the front ; and all will have the original line.

If we wish them to half turn to the right, we shall command them to make two quarter-turns in that direction ; and when we wish them to resume the original position, we shall command them to half turn to the right—for the original position is again taken by four quarter-turns in the same direction—; when this has been done we shall command the file-leaders to hold their position, the rest to about face, and the rear ranks to advance and then about face ; and we shall now command the right file to hold its position, and the rest to left face, advance, resume the original interval from one another, and then face to the front ; and in this way the battalion will return to the original position.¹

If we wish to half turn to the left, we shall give the command in just the opposite way, to quarter

¹ These marchings are necessary to change from the compact formation, in which all wheeling by battalions is done, to the normal formation with interval of three cubits.

Asclep. xii. 6 = Ael. xxxii. 6-7.

Asclep. xii. 7 = Ael. xxxii. 8-9.

⁸ ἀποκαθιστάναι K. and R.

⁹ For what has obviously fallen out (the *εἰ* below after *δὲ* in F is probably a remnant of it, as K. and R. saw), K. and R. suggest εἶτα ἀποκαταστήσαι βουλόμενοι πάλιν ἐπ' ἀσπίδα δις ἐπιστρέφειν ; compare Aelian, *Tactica*, xxxii. 8.

ASCLEPIODOTUS

. . . ἀλλὰ μὴ ἐπὶ δόρυ, καὶ¹ ταῖς ὁμοίαις ἀγωγαῖς χρῆσασθαι. ὁμοίως δὲ καὶ ἐκπερισπάσαι βουλόμενοι τρὶς ἐπιστρέψομεν τὰ συντάγματα.

8 Ἐὰν δὲ κατὰ κέρας τὴν φάλαγγα πυκνῶσαι δέη, παραγγελοῦμεν ἐπὶ τοῦ δεξιοῦ τὸν δεξιὸν λόχον ἡρεμεῖν, τοὺς δὲ λοιποὺς ἐπὶ δόρυ κλίναντας προσάγειν ἐπὶ τὸ δεξιόν, ἔπειτα εἰς ὀρθὸν ἀποδιδόναι, καὶ προσάγειν τὰ ὀπίσω ζυγά. ἀποκαταστῆσαι δὲ προαιρούμενοι παραγγελοῦμεν τὸ μὲν λοχαγοῦν ζυγὸν ἡρεμεῖν, τὰ δ' ὀπίσω ζυγά μεταβαλλόμενα ἀνιέναι,² εἶτα πάλιν μεταβάλλεσθαι, ἔπειτα τοῦ δεξιοῦ λόχου ἡρεμοῦντος οἱ λοιποὶ ἐπ' ἀσπίδα κλίναντες προαγέτωσαν, ἕως ἂν τὰ ἐξ ἀρχῆς διαστήματα συντηρήσαντες εἰς ὀρθὸν ἀποδώσωιν.³

9 Εἰ δὲ τὸ λαιὸν κέρας πυκνῶσαι δέη, τὰναντία παραγγελοῦμεν, εἰ δὲ τὸ⁴ μέσον τῆς φάλαγγος, τὴν δεξιὰν ἀποτομὴν ἐπ' ἀσπίδα κλίναντες, τὴν δὲ λαιὰν ἐπὶ δόρυ, εἶτα προσάγειν⁵ κελεύοντες ἐπὶ τὸν ὀμφαλὸν τῆς φάλαγγος, ἔπειτα εἰς ὀρθὸν ἀποδοῦναι καὶ⁶ προσάγειν τὰ ὀπίσω ζυγά, ἔξομεν ὃ προαιρούμεθα. ἀποκαταστῆσαι δὲ βουλόμενοι μεταβάλλεσθαι παραγγελοῦμεν καὶ προάγειν κατὰ ζυγά χωρὶς τοῦ πρώτου, ἔπειτα πάλιν μεταβάλλεσθαι, καὶ τὴν μὲν δεξιὰν διφαλαγγίαν ἐπὶ δόρυ,

¹ C (Salmasius), K. and R.: εἰ F.

² K. and R. (AB?): ἀνιένθαι F (C).

³ K. and R.: ἀποδώσειν F.

⁴ K. and R.: τὸν F.

⁵ K. and R. (Aelian, *Tactica*, xxxiii. 4): προάγειν F.

⁶ Supplied by K. and R.

¹ As in § 6 above.

² That is, the centre, the point of division between the two wings.

TACTICS. XII. 7-9

turn twice to the left, [and then, wishing to return to the original position, we shall command them to quarter turn twice to the left,] not to the right, and to perform the similar¹ evolutions. In the same way, when we wish to make the three-quarter-turn, we shall make the battalions perform three quarter-turns.

If the phalanx must assume the compact formation by wings, we shall give the command, if on the right wing, for the right file to hold its position and for the other files to right face, close up to the right, and then face to the front, and for the rear ranks to advance. Then, if we wish to resume the original position, we shall command the rank of file-leaders to hold its position, the rear ranks to about face and advance, and then again to about face; after that, while the right file holds its position, let the other files left face and advance, until they have resumed their original intervals, when they face to the front.

If the left wing must assume the compact formation, we shall give the opposite commands. If the centre must assume the compact formation, we shall command the right wing to left face and the left wing to right face, then to advance to the navel² of the phalanx, to face to the front, and to advance the rear ranks, and we shall have the desired formation. If we wish the wings to resume their former position, we shall command them to about face and all the ranks save the first to advance and then about face; and we shall order the right wing to

Asclep. xii. 8=Ael. xxxiii. 1-2.

Asclep. xii. 9=Ael. xxxiii. 4-6.

ASCLEPIODOTUS

τὴν δὲ λαιὰν ἐπ' ἀσπίδα κλῖναι, εἶτα κατὰ λόχους ἀκολουθεῖν τοῖς ἡγουμένοις, ἄχρις ἂν τὰ ἐξ ἀρχῆς λάβωσι διαστήματα, εἶτα εἰς ὄρθον ἀποδοῦναι.

Δεῖ δὲ ἄνω τὰ¹ δόρατα εἶναι ἐν ταῖς πυκνώσεσι πρὸς τὸ μὴ ἐμποδῶν² ταῖς κλίσεσι γίνεσθαι.

- 10 Ταῖς δ' αὐταῖς ἀγωγαῖς χρησίμαις οὔσαις πρὸς τὰς τῶν πολεμίων αἰφνιδίους ἐπιφανείας³ καὶ⁴ τοὺς ψιλοὺς ἀσκήσομεν.

. . .⁵ τὰ μὲν φωνῆ, τὰ δὲ διὰ σημείων ὄρατῶν, ἔνια δὲ καὶ διὰ τῆς σάλπιγγος. σαφέστατα μὲν γάρ ἐστι τὰ⁶ διὰ φωνῆς δηλούμενα—οὐ μὴν πάντοτε δυνατὸν διὰ κτύπον τῶν ὄπλων ἢ διὰ πνευμάτων σφοδρῶν ἐμβολάς, ἀθορυβώτερα δὲ τὰ διὰ τῶν σημείων· ἀλλ' ἐνίοτε καὶ τούτοις ἐπιπροσθοίη⁷ ἢ⁸ ἡλίου ἀνταύγεια ἢ παχύτης ἀέρος καὶ κονιορτοῦ ἢ καὶ ὄμβρου πλήθος, δι' ὃ οὐ ράδιον πρὸς πάσας τὰς ἀνακυπτούσας⁹ χρείας εὐπορηῆσαι σημείων, οἷς προσήθισται¹⁰ ἢ φάλαγξ, ἀλλ' ἐνίοτε¹¹ πρὸς τοὺς καιροὺς ἀνάγκη καινὰ προσευρίσκειν, πλὴν ἀδύνατον ἅπαντα συμπεσεῖν, ὥστ' ἄδηλον εἶναι καὶ σάλπιγγι καὶ φωνῆ καὶ σημείῳ τὸ παράγγελμα.

- 11 Τὰ μέντοι διὰ φωνῆς σύντομά¹² τε εἶναι δεῖ καὶ ἀναμφίβολα. τοῦτο ἂν¹³ γένοιτο, εἰ τὰ ἰδικὰ¹⁴ τῶν γενῶν τε καὶ κοινῶν προτάττοιμεν· ἀμφί-

¹ τα F.

² ἐμποδον F.

³ αἰφνιδίους ἐπιφανείας τῶν πολεμίων C (Salmastius), K. and R.

⁴ Added by K. and R.

⁵ For the obvious lacuna K. and R. suggest from the parallel passage in Aelian and Arrian, *op. cit.*, xxxv. Ἰ τὰ δὲ παραγγέλματα ὀξέως δέχεσθαι τὴν στρατιὰν ἀσκήσομεν, τὰ μὲν κτλ.

⁶ Supplied by K. and R.

⁷ K. and R. : ἐπιπροσθεῖη F.

⁸ Supplied by K. and R. (without any note : in ABC?).

⁹ ἀντικυπτούσας K. and R. (probably a mere misprint).

TACTICS, XII. 9 - 11

right face and the left wing to left face, to follow by files the leading files until they have the original intervals, and then to face to the front.

In the compact formations the spears must be elevated, so as not to interfere in the turnings.

We shall train the light infantry also in the same evolutions, which are so advantageous in case the enemy appears suddenly.

[We shall, furthermore, train the army to distinguish sharply the commands] given sometimes by the voice, sometimes by visible signals, and sometimes by the bugle. The most distinct commands are those given by the voice, but they may not carry at all times because of the clash of arms or heavy gusts of wind; less affected by uproar are the commands given by signals; but even these may be interfered with now and then by the sun's glare, thick fog and dust, or heavy rain. One cannot, therefore, find signals, to which the phalanx has been accustomed, suitable for every circumstance that arises, but now and then new signals must be found to meet the situation; but it is hardly likely that all the difficulties appear at the same time, so that a command will be indistinguishable both by bugle, voice, and signal.

Now the commands by voice must be short and unambiguous. This would be attained if the particular command should precede the general,

Asclep. xii. 10 = Ael. xxxv.

Asclep. xii. 11 = Ael. xl-xlii.

¹⁰ προσείθισται K. and R.

¹¹ ἀλλένισται F.

¹² K. and R.: σύντονά F which might be defended ('sharp,' 'crisp') were it not that Arrian and Aelian, *ορ. cit.*, xl. 1, have σύντομα in the parallel passage.

¹³ δ' ἄν K. and R. (AB?): οὐ. δ F (C).

¹⁴ εἵταιδικὰ F.

ASCLEPIODOTUS

βολα¹ γὰρ τὰ κοινά· οἶον οὐκ ἂν φήσαιμεν “ κλῖναι ἐπὶ δόρυ,”² ἀλλ’ “ ἐπὶ δόρυ κλῖναι,” ἵνα μὴ διὰ τὴν προθυμίαν οἱ μὲν ἐπ’ ἄλλο, οἱ δὲ ἐπ’ ἄλλο τῆς κλίσεως προειρημένης νεύσωσιν,³ ἀλλ’ ὁμοῦ τὸ αὐτὸ ποιήσωσιν· ὡς δὲ οὐδὲ “ μεταβάλλου⁴ ἐπὶ δόρυ,” ἀλλ’ “ ἐπὶ δόρυ μεταβάλλου⁵” φήσαιμεν, οὐδ’ “ ἐξέλισσε⁶ τὸν⁷ Λάκωνα,” ἀλλ’ ἀνάπαλιν “ τὸν Λάκωνα ἐξέλισσε” καὶ . . .⁸

. . . παράστηθι ἐπὶ τὰ ὄπλα. ὁ σκευοφόρος ἀποχωρεῖτω τῆς φάλαγγος. ἡσυχία δὲ ἔστω καὶ προσέχετε τῷ παραγγέλματι. ὑπόλαβε⁹ τὴν σκευήν· ἀνάλαβε. διάστηθι. ἀνάλαβε τὸ δόρυ. στοίχει, ζύγει,¹⁰ παρόρα ἐπὶ τὸν ἡγούμενον. ὁ οὐραγὸς ἀπευθυνέτω τὸν ἴδιον λόχον. συντήρει τὰ ἐξ ἀρχῆς διαστήματα. ἐπὶ δόρυ κλῖνον,¹¹ πρόαγε, ἔχου οὕτως. τὸ βάθος διπλασίαζε, ἀποκατάστησον. τὸ βάθος ἡμισίαζε, ἀποκατάστησον. τὸ μῆκος διπλασίαζε, ἀποκατάστησον. τὸν Λάκωνα¹² ἐξέλισσε, ἀποκατάστησον. ἐπίστρεφε, ἀποκατάστησον. ἐπὶ δόρυ περίσπα,¹³ ἀποκατάστησον ἢ ἐπικατάστησον, κατὰ τὰ αὐτὰ καὶ ἐπ’¹⁴ ἀσπίδα.

Αὗται διὰ βραχέων αἱ τοῦ τακτικοῦ καθηγήσεις, τοῖς μὲν χρωμένοις σωτηρίαν πορίζουσαι, τοῖς δ’ ἐναντίοις κινδύνους ἐπάγουσαι.

¹ ἀμφ’ ὄλα F.

² ἐπίδου followed by space of four letters F (ἐπὶ δόρυ A 2nd hand in margin).

³ νεύσωσιν K. and R. (perhaps a misprint, as there is no note).

⁴ K. and R.: ὥστε οὐδὲν μεταβάλλου F.

⁵ K. and R.: μεταβάλλειν F.

⁶ K. and R.: ἐξελισσαι F.

⁷ K. and R.: τὴν F.

⁸ What has been lost here, probably two or three sen-

since the general are ambiguous. For example, we would not say, "Face right!" but "Right face!", so that in their eagerness some may not make the turn to the right and others to the left when the order to turn has been given first, but that all may do the same thing together; nor do we say, "Face about right!" but "Right about face!" nor "Counter march Laconian!" but "Laconian counter march!" and

. . . Stand by to take arms! Baggage-men fall out! Silence in the ranks! and Attention! Take up arms! Shoulder arms!¹ Take distance! Shoulder spear! Dress files! Dress ranks! Dress files by the file-leader! File-closer, dress file! Keep your original distance! Right face! Forward march! Halt! Depth double! As you were! Depth half! As you were! Length double! As you were! Laconian counter march! As you were! Quarter turn! As you were! Right half turn! As you were! or Forward to position! either Right!² or Left!

These are in brief the principles of the tactician; they mean safety to those who follow them and danger to those who disobey.

¹ 'Arms' (*σκεινή*) here probably mean merely the defensive equipment, shield and helmet.

² Literally, 'in the same direction,' *i.e.*, to the right.

tences containing further illustrations, the reason for this order in giving commands, and the sentence introductory to the following list of commands, can be recovered from the parallel passage in Arrian and Aelian, *op. cit.*, xl. 4-xlii. 1.

¹¹ K. and R.: *ὑπέλαβε* F.

¹⁰ *στοιχει ζυγει* F.

¹² K. and R. (AB?): *κεινον* F.

¹³ *λάκων* F.

¹³ *περισπα* F.

¹⁴ K. and R. (AB?): *ἐπι* F.

A LIST OF SOME OF THE MORE IMPORTANT TECHNICAL TERMS IN ASCLEPIODOTUS¹

- ἀκροβολιστής*, skirmisher; of horsemen, i. 3; vii. 1.
- ἄκρον*, wing of a line of battle, i. 3.
- ἀμφίστομος -ον*; *πορεία ἀμφίστομος*, when the main divisions of an army march in parallel or in column formation with the line of front-rank men on the outside, iii. 5; x. 22; xi. 3 and 4.
- ἀναστρέφω*, to wheel to the original position, after a military evolution, = *ἀποκαθίστημι*, *ἀποκαθιστάνω*, xii. 3.
- ἀναστροφή*, wheeling back to the original position, x. 1 and 6; wheeling in general, vii. 3 (also vii. 2 K. and R.).
- ἀντιπορεία*, counter attack, or frontal attack, x. 2.
- ἀντίστομος -ον*; *πορεία ἀντίστομος*, when the main divisions of an army march in parallel formation with
- the line of front-rank men on the inside, xi. 3.
- ἀποκαθίστημι*, to return to the original position, xii. 11. etc.
- ἀποκατάστασις*, return to original position after wheeling or other evolutions, x. 1; 9 and 11. Cf. *ἐπικατάστασις*.
- ἀπόστασις*; *ἐν ἀποστάσει*, at a distance, at some interval, x. 21.
- [*ἀποστροφή*, wheeling away (from the enemy), retreat, vii. 2 (Oldfather).]
- ἀποτομή*; *ἀποτομή κέρατος*, half-wing, or corps, theoretically 4096 men, ii. 10; iii. 1 and 2.
- ἀραιός -ά -όν*, open, wide, opposed to *πυκνός*, of the space between soldiers in array, iv. 1.
- ἀραρός* (neu. perf. ptc. of *ἀραρίσκω* used as a substantive), joining - point, point of division between

¹ No attempt has been made to include every technical term, or all instances of each term cited, but only the most noteworthy or unusual.

LIST OF TECHNICAL TERMS

- the two wings of an army, ii. 6.
- άρματαρχία, unit of sixteen war-chariots, viii. 1.
- ἀσπίδισκη, small shield, i. 2.
- ἀσπίς, shield; ἐπ' ἀσπίδα, to the left, x. 1, etc.
- δεκανία, decury, older designation for a file (λόχος), ii. 2.
- διάστημα, interval between soldiers in rank and in file, iv. 1.
- δίππευσις, breaking through with cavalry, vii. 3.
- δίσθημι, to take distance, for the different spacings in the ranks, xii. 11; cf. διάστημα.
- διλοχία, two files, ii. 8 and 10; iii. 4.
- διλοχίτης, commander of two files, ii. 8.
- διμοιρία, half-file, where the file had twelve men, ii. 2.
- διμοιρίτης, leader of a half-file, ii. 2.
- διπλασιάζω, to double either the number of soldiers in a given area, or the area by deploying the soldiers, x. 1.
- διφαλαγγία, double corps, or wing, theoretically 8192 men, ii. 10.
- διχοτομία, point of division, ii. 6.
- δορατοφόρος -ον, spear-bearing, of cavalry, i. 3.
- δόρυ, spear; ἐπὶ δόρυ, to the right, x. 1, etc.
- δρεπανηφόρος -ον, scythe-bearing, of chariots, viii. 1.
- εἰλη, squadron of cavalry, vii. 2.
- ἐκατοντάρχης = ταξίαρχος, captain of hundred, really 128 men, ii. 8.
- ἐκατονταρχία, two platoons of light-armed troops, a company, composed of 128 men, vi. 3.
- ἐκπερισπασμός, three-quarter-turn, x. 1 and 8.
- ἐκτακτός -η -ον; οἱ ἐκτακτοί, the supernumeraries, attached originally to the τάξις, but later either to the σύνταγμα, ii. 9, or the ἐκατονταρχία of light-armed troops, vi. 3, or the φάλαγξ of light-armed troops, vi. 3.
- ἐλεφαντάρχης, commander of sixteen war-elephants, ix. 1.
- ἐμπλέκω, to incorporate, of light infantry, man beside man, in the phalanx of hoplites, vi. 1.
- ἐναντίος -α -ον; ἀπ' ἐναντίας, on the other hand, i. 2.
- ἐνωμοτάρχης, leader of an ἐνωμοτία, ii. 2.
- ἐνωμοτία, quarter-file, ii. 2.
- ἐξάριθμος -η -ον, outside the normal number, or in addition to it, ii. 9.
- ἐξελιγμός, counter-march, x. 13 ff.
- ἐξελίσσω, to counter march, x. i; xii. 11.

ASCLEPIODOTUS

- ἐπαγωγή*, sequence formation, *i. e.*, when one wing follows the other, both marching in column, x. 1; xi. 2 and 4.
- ἐπιθήραρχία*, a unit of four war-elephants, ix. 1.
- ἐπιθήραρχος*, a commander of four war-elephants, ix. 1.
- ἐπικαθίστημι*, to advance to original position, x. 10; *cf.* *ἐπικατάστασις*.
- ἐπικάμπιος -ον*; *ἐπικάμπιος εἰς τοῦπίσω* (*sc.* *φάλαγξ*), half-square march backward, xi. 1; *ἐ. εἰς τὸ πρόσω*, the same forward, xi. 1.
- ἐπικατάστασις*, advance to original position after wheeling, x. 1 and 9; *cf.* *ἀποκατάστασις*.
- ἐπικοινωνέω*, to be attached to, or stationed upon, i. 3.
- ἐπιλαρχία*, battalion of cavalry, vii. 11.
- ἐπιξεναγία*, a division of light-armed troops, 2048 men, vi. 3.
- ἐπιξεναγός*, commander of an *ἐπιξεναγία*, vi. 3.
- ἐπιστάτης*, 2nd, 4th, 6th, etc., man in a file, ii. 3 and 4; iv. 2.
- ἐπιστροφή*, quarter-turn, x. 1, 4, etc.; wheeling towards (the enemy), attack, vii. 2.
- ἐπισυζυγία*, unit of eight war-chariots, viii. 1.
- ἐπίταγμα*, supporting-force, the phalanx of light-armed troops, 8192 men, vi. 3;
- vii. 10; the full force of cavalry, vii. 11.
- ἐπίταξις*, supporting-position, x. 1 (*cf.* vii. 10).
- ἐπιφάνεια*, facing-right, or -left, of an army, x. 4 and 5.
- ἐτερόστομος -ον*; *ἐτερόστομος πορεία*, when the wings of an army march in column, with their front-line men on opposite sides, xi. 4.
- ἐφιππαρχία*, division of cavalry, vii. 11.
- ζυγαρχέω*, *cf.* *ζυγάρχης*, vii. 9.
- ζυγάρχης*, rank-leader in cavalry, the man at the corner of each rank when in wedge-formation, vii. 9.
- ζυγαρχία*, a unit of two war-chariots, viii. 1.
- ζυγέω*, to stand in ranks, of a phalanx, ii. 6; of a cavalry squadron, vii. 4 and 5, etc.
- ζῶαρχος*, driver or commander of a war-elephant, ix. 1.
- ἡμιλόχιον*, half-file, ii. 2.
- ἡμιλοχίτης*, commander of a *ἡμιλόχιον*, ii. 2.
- ἡμισιάζω*, to halve intervals, xii. 11.
- θηραρχία*, unit of two war-elephants, ix. 1.
- θήραρχος*, commander of two war-elephants, ix. 1.
- θυρεοφόρος -ον*, bearing a large, oblong shield, of cavalry, i. 3.

LIST OF TECHNICAL TERMS

- λάρχης*, (1) front-man of a cavalry squadron, stationed at the point of the wedge, vii. 2; 3, etc.; (2) commander of eight war-elephants, ix. 1.
- ἱππαρχία*, two *Ταραντιναρχίαι* (q.v.) of cavalry, vii. 11.
- κατάπυκνος* -ον; *ἐν καταπύκνῳ στάσει*, in compact formation, v. 1.
- κεράρχης*, (1) commander of a wing, 8192 men, ii. 10; (2) commander of thirty-two war-elephants, ix. 1.
- κέρας*, (1) wing of an army, formerly 2048 men = *μεραρχία*, later a double-corps, consisting of 8192 men, ii. 10; (2) squadron of thirty-two war-chariots, viii. 1.
- κλίσις*, right- or left-face, x. 1 and 2.
- κοιλέμβολος*, hollow-wedge, xi. 5.
- κοῖλος* -η -ον; *κοίλη φάλαγξ*, concave formation, xi. 1.
- κυρτός* -ή -όν; *κυρτή φάλαγξ*, convex formation, xi. 1.
- λοξός* -ή -όν; *λοξή φάλαγξ*, a phalanx in march with extended front, one wing in advance of the other, x. 1; xi. 1.
- λοχαγός*, first man and leader of a file (*λόχος*), ii. 2, etc.
- λόχος*, a file, consisting of sixteen men, ii. 1, etc.
- μεράρχης*, commander of a *μεραρχία*, ii. 10.
- μεραρχία*, command of 2048 men, a division, ii. 10; iii. 2.
- μεταβάλλω*, (act.) to cause to about face, xii. 5; (mid.) to about face, xii. 3.
- μεταβολή*, about-face, x. 1 and 3.
- μεταγωγή*, manœuvring, wheeling, vii. 5.
- μετατάττω*, to reorganize, ii. 2.
- μέτωπον*, front line of phalanx, ii. 5; iv. 4; v. 1 and 2.
- μηκος*, first line of a phalanx, ii. 5.
- ξεναγία*, two battalions of light-armed troops, a regiment of 512 men, vi. 3 [supplied from Aelian, *Tactica*, xvi. 3].
- ὀκταλοχία*, a military unit of eight *λόχοι*, ii. 9.
- ὀμόζυγος*, comrade-in-rank, ii. 4. Cf. *παραστάτης*.
- ὀμοίοστομος* -ον; *πορεία ὀμοίοστομος*, when the divisions of an army march in parallel formation, with the front-line men on the same side, xi. 3; or in column, with the same disposition, xi. 4.
- ὀμφαλος*, centre, point of division between the two wings, ii. 6; xii. 9.
- ὄρθιος* -α -ον; *φάλαγξ ὄρθια*, the phalanx marching forward in file, or in column, xi. 1 ff.

ASCLEPIODOTUS

- ὀρθός* -ή -όν; *eis* ὀρθὸν ἀποδοῦναι, to face the front originally held, lines front, x. 1 and 12; xii. 6, etc.
- οὐρά*; ἐπ' οὐράν, about face to the rear from the enemy, x. 3; ἀπ' οὐράς, about face to the rear toward the enemy, x. 3.
- οὐραγός*, (1) the last man in file, file-closer, ii. 2; iii. 6, etc.; (2) the man at the rear corner of a squadron, vii. 2, etc.; (3) a supernumerary to the τάξις, ii. 9; iii. 6; or the ἑκατονταρχία, vi. 3.
- ὄχηματικός* -ή -όν, pertaining to the mounted force of an army, whether cavalry, chariots, or elephants, i. 1 and 3.
- παραγωγή*, march in line, where the phalanx on the march keeps the original battle-line, x. 1; xi. 1 ff.
- παραστάτης*, comrade-in-rank, ii. 4; iv. 2. Cf. ὁμόζυγος.
- παράταξις*, first line, or front line, of a phalanx. ii. 5.
- παρεδρεύω*; ὁ παρεδρεύων, comrade behind in file, iii. 6.
- παρεμβολή*, insertion, differing from *παρένταξις* in that soldiers of the same branch are inserted in the battle-line, as hoplites beside hoplites, vi. 1.
- παρένθεσις*, insertion, general term including both *παρεμβολή* and *παρένταξις*, vi. 1.
- παρένταξις*, insertion, differing from *παρεμβολή* in that soldiers of different branches of the army, as light-armed troops, are inserted in the phalanx of hoplites, man beside man, vi. 1.
- πεντακοσιάρχης*, commander of a *πεντακοσιαρχία*, ii. 10.
- πεντακοσιαρχία*, command of 512 men, ii. 10; iii. 3.
- πεντηκονταρχία*, two squads of light-armed troops, a platoon, composed of sixty-four men, vi. 3.
- περισπασμός*, half-turn, x. 1 and 7.
- πλάγιος* -α -ον; *πλαγία φάλαγξ*, an army in march with the front extended, x. 1; xi. 1.
- πλαγιοφύλαξ*, guard on the flank of a wedge-shaped squadron, vii. 2; 6, etc.
- προαγωνίζομαι*, to open battle, vii. 1.
- πρόπτωσις*, projection of spears before a phalanx, v. 1.
- προσένταξις*, flank-position, used of light infantry stationed on the wings of the phalanx, vi. 1.
- πρόσωπον*, front line of phalanx, ii. 5.
- πρόταξις*, position of the light-armed troops in front of the phalanx, vi. 1.
- πρωτολοχία*, front line of the phalanx, ii. 5.
- πρωτοστάτης*, front man in a

LIST OF TECHNICAL TERMS

- file, ii. 3; also 1st, 3rd, 5th, etc., man in a file, *ibid.*, 3 and 4.
- πύκνωσις*, close order, a compact arrangement used in attack, the men being spaced two cubits from one another, iv. 1 and 3; xii. 4 and 9.
- σαλπικτήης*, bugler, ii. 9; vi. 3.
- σημειοφόρος*, signalman, ii. 9; vi. 3.
- Σκύθης*, branch of cavalry armed only with bows, i. 3.
- στίφος*, two divisions of light-armed troops, a corps, 4096 men, vi. 3.
- στίχος*, a row of soldiers, used for both 'rank' and 'file,' ii. 5; as an old designation of 'file,' ii. 2.
- σταιχέω*, to be in file, of a phalanx, ii. 6; of a cavalry squadron, vii. 4 and 5, etc.
- στόμα*, front line of phalanx, ii. 5; xi. 1; van of army, xi. 1, etc.
- στρατηγός*, general, formerly of a corps of 4096 men, but properly commander-in-chief of a phalanx of 16,384 men, ii. 10.
- στρατοκῆρυξ*, army-herald, ii. 9; vi. 3.
- σύζευξις*; *κατὰ σύζευξιν*, used of the march of an army when the columns are parallel with each other; opposed to *κατ' ἐπαγωγὴν*, xi. 2.
- συζυγία*, a unit of four war-chariots, viii. 1.
- συλλοχισμός*, assembly of the files in parallel formation, constituting the phalanx, ii. 5.
- συνασπισμός*, formation with locked shields, to meet attack, iii. 6; iv. 3.
- συνεδρεύω*, to close up, draw together, of troops taking up the compact formation, iii. 6 (but *cf.* *crit.* note).
- συνεπιστέπω*, to protect at the same time, of armour protecting both man and horse, i. 3.
- σύνταγμα*, two companies or a battalion, ii. 8; iii. 6; *συνταξιαρχία* takes its place in ii. 10; iii. 3 and 4.
- συνταγματάρχης*, commander of a *σύνταγμα*, ii. 8.
- συνταξιαρχία*, battalion, ii. 9; takes the place of *σύνταγμα*, ii. 10; iii. 3 and 4.
- συνωμοτία*, a squad of soldiers bound by an oath, an early term for file (*λόχος*), ii. 2.
- σύστασις*, four files of light-armed troops, a squad, consisting of thirty-two men, vi. 3.
- σύστρεμμα*, brigade of light-armed troops, 1024 men, vi. 3.
- ταξιαρχία*, eight files (*λόχοι*)

ASCLEPIODOTUS

- of infantry, = τάξις, ii. 10 ; iii. 4.
- ταξίαρχος, commander of a company, composed of eight files (λόχοι), ii. 8.
- τάξις, a company, eight files (λόχοι) of infantry, ii. 8 and 9.
- Ταραντιναρχία, two battalions of cavalry, vii. 11.
- Ταραντίνος -η -ον ; οἱ Ταραντῖνοι, cavalry who fight only at a distance with javelins, i. 3.
- τελάρχης, commander of a τέλος = μεράρχης, ii. 10.
- τέλος, (1) in infantry, a division, 2048 men = μεραρχία, ii. 10 ; (2) in cavalry, a half-phalanx, vii. 11.
- τετράρχης, commander of a τετραρχία, ii. 8.
- τετραρχία, four files (λόχοι) of infantry, a platoon, ii. 8 ; iii. 4.
- τετράς ; κατὰ τετράδα, on a fourfold division or basis, iii. 1.
- τόξευμα, missile of any kind, i. 2.
- τοξότης, archer, part of the cavalry, i. 3.
- ὑπερβάλλω ; τὸ κέρασ ὑπερβαλέσθαι, to outflank on one wing, x. 2 and 18.
- ὑπερκεράω = ὑπερβάλλω, x. 18.
- ὑπερφαλαγγέω, to outflank on both wings, x. 18.
- ὑπηρέτης, aide-de-camp, ii. 9 ; vi. 3.
- ὑποβαίνω, to march behind, as one rank of soldiers marches a certain distance behind another, v. 1.
- ὑποστολή ; δι' ὑποστολῆς, held back, partly withdrawn, refused, x. 21.
- ὑπόταξις, rear-position, of light infantry stationed behind the phalanx, vi. 1.
- φαλαγγάρχης, (1) commander of a φαλαγγαρχία, ii. 10 ; (2) commander of a full force of sixty-four war-elephants, ix. 1.
- φαλαγγαρχία, corps, 4096 men, ii. 10 ; iii. 2.
- φάλαγξ, (1) any branch of the service, i. title ; i. 4 ; (2) specifically, the force of hoplites, consisting of 16,384 men, ii. 10, etc. ; (3) the full force of sixty-four war-chariots, viii. 1.
- χιλιάρχης, commander of a χιλιαρχία, ii. 10.
- χιλιαρχία, brigade, 1024 men, ii. 10 ; iii. 2 and 3.
- ψιλαγία, a command of two ἑκατονταρχίαι, a battalion of light-armed troops, vi. 3 [supplied from Aelian, *Tactica*, xvi. 3].

ONASANDER

PREFACE

IN the preparation of the present work Mr. Oldfather is primarily responsible for the introduction, text, and list of rare words. Mr. Titchener rendered assistance in collecting material and collating mss., and also prepared the first draft of the translation, which has been further revised by Mr. Pease.

WILLIAM A. OLDFATHER
ARTHUR STANLEY PEASE
JOHN B. TITCHENER.

URBANA, ILLINOIS, *Feb.* 1, 1922.

INTRODUCTION

OF Onasander, the author of the present *Στρατηγικός* (*sc.* λόγος), or *The General*, we know from the biographical article in Suidas that he was a Platonic philosopher who, in addition to a military work,¹ composed a commentary upon Plato's *Republic*.²

Traces of Platonic philosophy have been sought in the present work, especially in the admonition that friends should fight beside friends (Ch. 24), and in the distinction made between φθόνος and ζήλος (Ch. 42. 25). But the essence of the first idea is as old as Nestor's advice in the *Iliad* (B 362 f.) : it was practised among the Eleans, Italic Greeks, Cretans, and Boeotians, being characteristic of the Sacred Band of Thebes, and something similar may not have been unknown at one time in Sparta,³

¹ The mss. of Suidas give Τακτικά περί στρατηγημάτων. Bernhardt (following Küster) puts a comma after τακτικά, as though different works were referred to, but it is much more likely that only one was meant, whether we take the words περί στρατηγημάτων as explanatory of τακτικά, or suppose that ἡ has fallen out. In any event the title given by Suidas is inexact, for the better mss. of Onasander give *Στρατηγικός* (the inferior ones *Στρατηγικά* or *Στρατηγική*), which is undoubtedly correct, and is attested also by the so-called Leo xiv. 112. Suidas exemplifies late usage which applied τακτικά to any military treatise.

² This has left no trace.

³ The evidence is collected and discussed by Erich Bethe,

ONASANDER

hence it can hardly have escaped the attention of military writers. The same topic is treated also in extant literature from before the time of Onasander by Xenophon in his *Symposium*, viii. 32, 34, 35, so that, although Onasander can hardly have been ignorant of the famous passage in Plato (*Symposium*, 178 E ff.), it is hardly necessary to assume that this was the immediate source.

As for the discrimination between *φθόνος* and *ζήλος* there is no real parallel in Plato, whereas an almost exact counterpart exists in Aristotle (*Rhet.* ii. 11. 1), a circumstance which escaped Schwebel.¹ Such definitions, however, were the stock in trade of philosophers,² and do not presuppose a specific source unless there is some marked similarity in expression. On the contrary, one would rather be inclined to wonder that, in an ethical study of warfare like the present, a commentator upon Plato's *Republic* should have failed to show at any point some trace of the not infrequent references to war and its basic cause, the character of the good soldier,

Rhein. Mus., 1907, lxii: 445 ff. The *φίλων ἔλη* of the younger Scipio (Appian, *Hisp.* 84) seems to have been composed rather of friends of Scipio, than of mutual friends, so that I cannot agree with Wecklein, *Philol.*, 1876, xxiv: 413, who compares it with the *ἱερὸς λόχος* of Thebes. In Magna Graecia so closely connected was paederasty with war that it was even said to have been in origin a military measure. (Suidas s.v. *Θάμυρις*.)

¹ The Pseudo-Platonic *Ἔσοροι* (which Schwebel, following a very dubious tradition, ascribes to Theophrastus) give a somewhat different definition of *φθόνος*, and of *φθόνος* only.

² Compare the scholium to Aristophanes, *Plutus*, 87, where the definition of the word as given by the philosophers (*παρὰ τοῖς φιλοσόφοις*) is contrasted with that given by the rhetoricians. The Stoics, of course, had their definition, see Diog. Laert. vii. 111.

INTRODUCTION

the need of constant military exercise, the style of life of the soldier, the professional aspect of successful military preparation, mathematics as a necessary element in an officer's education, proposals looking toward the elimination of certain of the more cruel aspects of warfare, at least between civilized states, and similar topics discussed in that great work. Such silence on the part of Onasander, although not sufficient, perhaps, to cast doubt on the identity of our author with the writer mentioned by Suidas, would more naturally suggest that in *The General* we have a study anterior to a period of preoccupation with Plato.

The only other references to Onasander from antiquity are in Johannes Lydus, *De magistratibus*, i. 47, who names an Ὀνήσανδρος among Greek military writers, and in the *Tactica* of the so-called Leo,¹ xiv. 112, Ὀνήσανδρος δὲ καὶ αὐτὸς στρατηγικὸν συντάξας λόγον. In this connexion some conclusion must be reached about the proper form of the name, which has been much in doubt. The reading of all known mss. except F and D (see below under 'mss.' and 'Symbols'), supported by Suidas, is Ὀνόσανδρος and so the majority of editors print the name. On the other hand the earliest

¹ This work, long ascribed to Leo VI, is now known to antedate his period, and must go back to Leo III (A.D. 711-741), commonly, but incorrectly, called the Isaurian. This conclusion was first advanced by Zachariae von Lingenthal, *Byz. Zeitschr.*, 1894, iii: 437 ff., and the demonstration completed by K. Schenk, *ibid.*, 1896, vi: 298 f. Of course the Emperor is only to be regarded as the one under whose auspices the work was composed. See also R. Helbing in his review of R. Vari's new edition of the *Tactica*, Budapest, 1917 (unfortunately inaccessible as yet), in *Berl. philol. Wochenschr.*, 1919, 97.

ONASANDER

authorities, Johannes Lydus and the so-called Leo, of whom the latter must have had access to better sources than Suidas in this matter, give the form 'Ονήσανδρος.¹ Scholars have been divided, Schwebel (in his commentary), Fabricius, Koraes, M. Haupt, von Rohden, Jähns, Bechtel (*à propos* of an inscription, *Bezz. Beitr.*, 1896, xxi: 236) favouring 'Ονήσανδρος, while the early editors and translators uniformly, Haase, Köchly, K. K. Müller, Christ-Schmid, and works of reference in general employ 'Ονόσανδρος. As far as the then available evidence went it favoured slightly the spelling with η, for all the mss. but F go back to but a single source of the tenth century,² the period to which Suidas belongs, while the *Tactica* of Leo³ and the work of Johannes Lydus are respectively two and four centuries earlier. If the literary evidence is about evenly divided, then one feels inclined to decide in favour of the form 'Ονήσανδρος, because this, especially in its Doric form 'Ονάσανδρος, was a

¹ It is worthy of note that the so-called Leo has the correct form of the title, while the designation in Suidas is markedly inexact.

² See K. Krumbacher, *Byzant. Literaturgesch.*, 2nd ed., 1897, 638, and the literature there cited.

³ The author of this work must have had a ms. of Onasander before him, because he paraphrases a large part of the present treatise, and since he worked under the encouragement of the Emperor it is to be supposed that he had the best available sources. No doubt the author of the archetype of the majority of our present codices, in the tenth century, also had good ms. material to work upon, but that was two centuries later, and besides this archetype clearly represents a seriously corrupt and interpolated vulgate. The testimony of D, a late interpolated ms., for 'Ονήσανδρος is worthless.

INTRODUCTION

relatively common name,¹ while *Ὀνόσανδρος* seems to occur but once, and then, as Bechtel (*loc. cit.*) and others have thought, by a mere stone-cutter's error.²

Such was the status of the question until Dr. Rostagno's collation of the Florentinus, which is incomparably the best ms., showed that it had the following subscription :

ὈΝΑΣΑΝΔΡΟΥ ΣΤΡΑΤΗΓΙΚΟΣ:—

Plut. iv. 4 f. 215v.

a form of the name, which had been known, indeed, before, but because it appeared only in the late ms. B, had been rejected by Köchly with a "*sic!*" I have not, however, hesitated to accept it as the correct form of the name, partly because of the high value of the testimony of the Florentinus, but especially because it affords the best explanation of the other two forms, for *Ὀνόσανδρος* is an easy corruption of *Ὀνάσανδρος*, and *Ὀνήσανδρος* merely the Attic (or Koine) spelling.

With reference to the period in which Onasander lived, it can scarcely be doubted that the Quintus Veranius to whom the present work is dedicated was the consul of A.D. 49 who died while in command in Britain ten years later, so that 59 is the *terminus ante quem* for the composition of the treatise.³ If

¹ Approximately thirty-five instances have been noted, without making an exhaustive search, principally from Rhodes, Eretria, Athens, Laconia, and Ionia.

² *Ὀνόσανδρος* can hardly be derived from *δνος*, whatever one may think of the possibility of such a name among the Greeks, while the stem *ὀνόσασθαι*, as Bechtel observed, does not seem to appear in Greek nomenclature.

³ Earlier but baseless conjectures are mentioned by Schwebel, p. [8]. The year 58 might be more appropriately taken, as it is unlikely that Onasander would have dedicated

ONASANDER

we are inclined to press a little the author's own characterization of his work as *παλαιῶν τε ἡγεμόνων κατὰ τὴν σεβαστὴν εἰρήνην ἀνάθημα* (prooem. 4), and see in these words a reference to the time of composition being a moment of universal tranquility, we might accept Zur-Lauben's suggestion (preface, p. 6) that the treatise was composed in the year 53, this being perhaps the only one in the period for which there exists no record of military operations. But the expression employed, while certainly appropriate at a time of complete peace, does not necessarily imply quite so much, and it is better to rest content with a date shortly anterior to A.D. 59.¹

The treatise consists of forty-two chapters upon various aspects of a commander's duties, notably ethical considerations regarding the character, social status, bearing, behaviour, and attitude of a general towards his troops, the enemy, and his fellow-citizens; the morale of the troops, the effect of particular policies and tactics upon morale, and the like; together with much sound advice about elementary matters. In two respects Onasander differs markedly from other Greek and Roman military writers. He regards everything from the point

his work to Veranius after the latter had gone to Britain in this year. For Veranius see the article in *Prosop. Imp. Rom.* iii. 399 f.

¹ Some slight general confirmation of this approximate dating is supplied by von Rohden (see Bibliography), who finds approximately the same technique regarding the avoidance of hiatus in Onasander and in Ps.-Longinus, for the latter, it is now agreed, belongs to the period of the early empire. Von Rohden's results may, however, need modification, because they are based upon Köchly's text which departs at many places from the best ms. tradition in the matter of elision.

INTRODUCTION

of view primarily of the commanding officer, to the question of selecting whom he devotes a long and valuable passage, and he lays uncommon stress upon the *imponderabilia*, especially ethical and religious considerations. There is nothing very philosophic nor technically military in the treatise, which is intended to give merely the broad principles of generalship (στρατηγικαὶ ἰφηγγήσεις, prooem. 3), and lays no claim to originality (*ibidem*).¹

One feels no more inclined to extol the treatise as being "the most learned, concise, and valuable to be found upon the art of war,"² than to decry it as "useless and pedantic," and the author as one who "talks Greek like a doctor of the Sorbonne,"³ or to regard it as a mere "wilderness of general phrases," whose "useful observations are but grains in the chaff of trivialities."⁴ The truth, as often, lies here between extremes: κρατίστη δ' αἴρεσις ἡ τοῦ μέσου, as Onasander himself says (A, 10).

Actual performance falls below the statement in the prooemium that the study has drawn merely

¹ It seems unduly severe for Köchly and Rüstow: 1855, 84 and Max Jahns, 92, to denounce Onasander for lack of originality when he disclaims it himself.

² Guilliman writing in 1583, as quoted by Zur-Lauben, preface, p. 9.

³ The Prince de Ligne, as quoted by Jahns, 94. One's respect for the prince's judgement is seriously qualified, however, by the circumstance that he has the highest admiration for the so-called Leo (*ibid.* 120), ranging him beside Napoleon, and far above a mere Caesar or Frederick the Great, whereas the *Tactics* of Leo are in part a watered paraphrase of Onasander himself, together with extensive extracts from the *Strategica* ascribed to Mauricius, and from other sources.

⁴ Köchly and Rüstow: 1855, 85.

ONASANDER

upon those arts and practices employed by the Romans in the establishment of their empire, for specifically Roman institutions are regularly neglected even when appropriate, and in only one instance (Ch. 19) is a manœuvre recommended, which, though perhaps not impossible in a Greek phalanx, is certainly suggestive of the Roman maniple tactics. Elsewhere only general principles are proposed which apply to almost any army at any time, or else, although very rarely, if ever, is a custom peculiar to the Greeks described.¹ In particular many of the qualities which Onasander requires of a commander-in-chief, are, *mutatis mutandis*, quite as applicable to-day to higher officers in general, as they were in the reign of Claudius.

The burden of the treatise is really ethics, morale, and the general principles of success in arms. As such, a good deal of it will necessarily sound commonplace, some of it even trivial, for the principles of success in war have often been declared by experts

¹ Thus it has been noted that in Ch. 10. 25 ff. the Greek inspection of victims before battle is mentioned, not the Roman augury with the sacred chickens. But the Romans also took auspices before battle, no less than the Greeks, at least during the Republic. In the same chapter (10. 4) exercises for soldiers are mentioned, which are drawn from Xenophon (*Cyrop.* ii. 3. 17 f.). But similar exercises were employed by the Romans (see the article "Exercitus" in Pauly-Wissowa, 1654), and although exercise in throwing clods is not recorded for the Romans, so far as I am aware, Vegetius (ii. 23) especially recommends that soldiers be trained to throw stones, and in a sham battle what better substitute for these could be desired than clods? It is true that the Roman legion is not specifically mentioned, but neither is the Greek, for that matter. The word *φάλαγξ* could be used of either, but Onasander is writing of armies in general and not of particular forms of organization.

INTRODUCTION

to be very simple, and the difficult matter in war, as in many sports and occupations, is not the principles, but their application. Nevertheless every failure is easily traceable to the neglect of some important principle, and these can hardly be inculcated too often. If a manual expresses the principles of the art clearly and pointedly, one can hardly in fairness demand more of it. Estimates of value regarding a work of this kind will necessarily differ, but when so great a commander as Prinz Moritz von Sachsen, Marshal of France, and author likewise of a classic work on the art of war, *Mes Réveries*, "declared with pleasure that he owed his first conceptions of the conduct of a commander-in-chief to Onasander" (Zur-Lauben, preface, p. 5), no mere closet philologist, at all events, may deny the possibility that it may prove useful to the professional soldier. The little treatise is merely a plain tale simply told, and it is the better part of criticism to express appreciation of the work that is valuable and well done rather than to strain to find what is useless or inappropriate.

The style of Onasander is straightforward and not ill adapted to the subject matter. Although it is not so fluent and simple as that of Xenophon, whom he seems to have admired and followed,¹ it nevertheless stands comparison with that of Polybius or Plutarch, but only an enthusiast like Zur-Lauben could speak of its "beauté majestueuse, élégance nerveuse, et clarté perçante."

The influence of Onasander in antiquity was con-

¹ He was especially indebted to the *Cyropaedia* and the *Anabasis*. He drew also from Homer, Herodotus, Thucydides, and Polybius among extant authors, but is in no case slavishly dependent upon any particular source that has come down to us.

ONASANDER

siderable. Most subsequent military writers are indebted to him, notably the so-called Mauricius and Leo, of whom the latter in a large measure paraphrases Onasander, turning him into "wretched Byzantine Greek."¹ In the Renaissance he enjoyed a remarkable popularity. Translations, beginning with that of Sagundinus in 1493, appeared in rapid succession in Latin, Spanish, German, French, Italian, and English, and such a demand, for these were no mere philological exercises, shows that many a practical soldier took to heart his counsel, and that much of it has passed thereby into the common body of military science. Towards the end of the next century the first Greek text appeared, a fairly good piece of scholarship, by Rigaltius, which held its place until Schwebel's elaborate study, more than a century and a half later. Since that time Onasander has been known to few beside professional philologists, but it may be hoped that others outside the ramparts of scholarship may have their attention drawn to his work by the present unpretentious publication.

A few words seem to be necessary by way of explaining this edition. It would have been much easier to reprint Köchly's text, but inasmuch as only one of the four old and really valuable mss. of Onasander was adequately known (namely the Parisinus 2442), the great Laurentian ms. of the Tacticians had never been really collated, and the Vatican and the Neapolitan mss. never examined at all, it would have been scarcely proper merely to reproduce an old and occasionally imperfect, though in the main most admirable, text. The

¹ Köchly and Rüstow: 1855, 85, note 198.

INTRODUCTION

apparatus aims to give all the *ms.* readings that have any critical value, or may throw light upon the tradition of the text, and all the valuable emendations of modern scholars, especially those of Köchly. Knowledge of the inferior *mss.* and readings of earlier editors have been drawn generally from Köchly, whose work in this respect is most exact and thorough, although we have been able to use the work of Rigaltius from the edition of 1600 in a privately owned copy, as well as Schwebel's edition of 1762, and that of Koraes, 1822, lent by the courtesy of the libraries of Harvard University and Princeton University respectively. Departures from Köchly's text have generally been recorded except in matters of elision (where Köchly nearly always elided with or without *ms.* authority), and of movable *nu* (which Köchly added somewhat arbitrarily). In these points the best *ms.* authority (F, and frequently FGH) has been followed. Cases where FGH merely run preposition and substantive together have not been recorded, or where iota subscript (without indication of a different construction) has been omitted, or movable *nu* has been added or left off (except for F), or compound words written as two (unless such a usage is occasionally recognized), or obviously erroneous accents or breathings occur, or where GH have trivial misspellings. The punctuation of FGH has likewise not been recorded, although it has been duly regarded in constructing the text.

The bibliography, which is more complete perhaps than any to be found elsewhere, has been drawn up with especial care, and omits, we trust, no title of substantial value for the criticism of Onasander.

ONASANDER

EDITIONS

Nicolaus Rigaltius: Ὀνοσάνδρου Στρατηγικός. Onosandri Strategicus. Sive de imperatoris institutione. Accessit Οὐρβικίου Ἐπιτήδευμα. Paris, 1598 and 1599. This is the *editio princeps*.¹ It was republished in 1600 at Heidelberg by the Commelin Press with the notes of Portus and Gruterus, and again in 1604 with the notes of Portus, with which edition the more elaborate observations of Gruterus, published separately in the same year, were sometimes bound. See below.

[Henricus Monantholius: Onosandri et Aristotelis Mechanica cum commentariis. Paris, 1599. Fabricius, *Bibl. Graeca*, vol. iv. 339, quotes this entry from a Leyden catalogue, but the title itself is absurd, and the entries in the catalogues of the Brit. Mus. and the Bibl. Nat. under the Monantholius edition of Aristotle do not mention Onasander. We have here probably a cataloguer's error, due possibly to two different works being bound together. The Onasander was probably the edition of Rigaltius.]

¹ Max Jähns, *Gesch. der Kriegswiss.* i. 9, note, who mentions an edition of the *Scriptores* (i.e., the *Rei Militaris Scriptores*, Rome, 1487, and frequently thereafter), Rome, 1499, in which the collection is enlarged by the addition of Onasander's treatise, which, however, was again omitted in the edition of Bologna and the subsequent reprints, had no doubt in mind the Latin translation of Sagundinus, *q.v.*, which meets his description in every detail except that it appeared in the edition of Rome, 1494, only, not 1499.

INTRODUCTION

Aemilius Portus and Janus Gruterus : 'Ονοσάνδρου Στρατηγικός. Accedit seorsim in eundem Onosandrum Jani Gruteri uberior commentarius. Item Aemilii Porti . . . breues . . . observationes. Ex Officina Commeliniana [Heidelberg], 1600 ; also the work of Rigaltius and Portus alone, *ibidem*, 1604. Gruterus' notes were published also by the same firm in Varii discursus, sive prolixiores commentarii ad aliquot insigniora loca Taciti et Onosandri, Part I, 1604, and Part II, 1605.¹ These observations of Gruterus seem to have been bound occasionally with the edition of Rigaltius, and also with the notes of Portus, but not always, since the latter combination alone was used by Schwebel (preface, [6]). On the somewhat complicated relations of these three works see Schwebel, *loc. cit.* ; Fabricus, *op. cit.* 338 ; Haase : 1835, 98. The copy of the edition of 1600 owned by Mr. A. S. Pease, although its title-page professes to have Gruterus' notes, does not contain them. The *Notae* of Rigaltius are dated in both preface and colophon 1598.

Joannes à Chokier de Surlet : Onosandri Strategicus, sive de imperatoris institutione . . . , without place or date, but the preface is dated Rome, 1610. This edition is a part of Chokier's *Thesaurus aphorismorum politicorum*, Rome, 1611. It contains the text and translation of Rigaltius.

¹ The copy in the Brit. Mus. is described thus : " Another edition) [*i.e.*, of Rigaltius]. Accessit Urbici inventum, Graece et Latine : interprete N. Rigaltio, cujus notae adjiciuntur notae ; ut item J. Gruteri discursus varii. . . . In Bibliopolio Commeliniano : [Heidelberg] 1604, 1600-05."

ONASANDER

Its only value lies in the "political dissertations" added by Chokier. The *Thesaurus* (containing Onasander) was republished at Mainz, 1613 and 1619 (third ed.; Cat. Bibl. Nat.); Frankfurt, 1615; Liège, 1643; Köln, 1649, 1653, and 1687. The editions of Liège and Köln do not contain the Greek text (Cat. Bibl. Nat.).

Nicolaus Schwabelius: *Onosandri Strategicus, sive de imperatoris institutione liber, etc., . . . notis perpetuis criticis emendatus. . . . Accedunt duo indices, etc. . . .* Nürnberg [1762]. This is commonly bound with the translation of Zur-Lauben, Paris, 1757.

A. Koraes (Korais, Corais, or Coray): *Ἰουλιανῶν Στρατηγικὸς καὶ Τυρταίου τὸ πρῶτον Ἐλεγείον, μετὰ τῆς Γαλλικῆς ἑκατέρου μεταφράσεως. Παρέργων Ἑλληνικῆς βιβλιοθήκης τόμος πέμπτος*, Paris, 1822. The French translation is that of Zur-Lauben, which Koraes reproduces even when it is based upon readings different from those which he prints.

Arminius Koechly: *Ἰουλιανῶν Στρατηγικός. Onosandri de imperatoris officio liber*. Leipzig, 1860. This is the most valuable edition of the text. It completely supplants the earlier editions, using all the critical materials previously collected, and adds new manuscript readings, especially from one of the oldest mss., Paris. 2142.

INTRODUCTION

TRANSLATIONS

Latin

Nicolaus Sagundinus : Onosander ad Q. Verānium de optimo imperatore eiusque officio per Nicolaum Sagundinum (*sic*),¹ e Graeco in Latinum traductus. Rome, 1494.² This publication was in the well-known and frequently reprinted *Rei militaris scriptores*, which included among others Vegetius, Frontinus, Modestus, and Aelian. Only the 1494 edition, however, contains Onasander. This translation of Onasander was reprinted at Paris, 1504 (colophon) or 1506 (preface); at Basel, 1541, 1558, and 1570.³

Joachimus Camerarius : Onosandri Graeci autoris de re militari commentarius in Latinum sermonem conversus. . . . Nürnberg, 1595. This was an independent work made from a mutilated ms. It was published after the death of Camerarius by his sons. Max Jähns, *Gesch. der Kriegswiss.* 93, is certainly in error in

¹ There seems to have been some doubt as to the correct spelling of the name. The *editio princeps* and the Paris reprint have *Sagundinus*, the Basel reprints and editors use the form *Saguntinus*. Fabricius, *Bibl. Gr.* iv. 337, and Haase, 1835, 99 give some references where the form *Secundinus* appears.

² So Haase, 1835, 98; Köchly in his edition, p. vii.; and the catalogues of the Brit. Museum and the Bibl. Nat. and Hain* 15915. Fabricius, *loc. cit.*, gives 1493.

³ A Latin translation in ms. exists in the Escorial library, iii. S. 11; also at London, 12 C. XIII, the latter under the name *Nicolao Secundino*, so that the P'scurial translation is probably the same work; see Haase. 1835, 99.

ONASANDER

speaking of this edition as containing also the Greek text.

Nicolaus Rigaltius. For his translation and reprints of it, see under *Editions*, Rigaltius, Portus, and Chokier. The Latin translation by itself was published at Helmstadt in 1619.¹

Spanish

Al. de Palencia: *Tratado de la perfeçion del triunfo militar*. Printed about 1495, but without indication of place or date. The translation was composed in 1459.²

Iac. Dieg. Gracian de Aldarete: *Onosandro Plátonico de las calidades y partes que ha de tener un excelente capitan general y de su officio y cargo*. Barcelona, 1567.

German

ANON.: *Onexander von den Kriegsshandlungen und Ráthen der hocherfarn guten Hauptleut sampt iren Zugeordenten*. Mainz, 1524 and 1532.³

¹ It is more than doubtful if the work of Dominicus Syllenius Graecus, described by Fabricius, *op. cit.*, 339, under the heading *Versiones*, as being "de vetere et recentiore scientia militari, omnium bellorum genera terrestria perinde ac naualia, nec non tormentorum rationes complectente. Venet. 1599", contains a translation of Onasander.

² Max Jähns, *Gesch. der Kriegswiss.*, 93.

³ Fabricius, *loc. cit.*, gives 1531. This translation is said to contain a chapter, otherwise unknown, upon the Athenians, Spartans, and Macedonians. See Zur-Lauben, quoted by Fabricius, *loc. cit.*; Jähns, *op. cit.*, 93. It can hardly fail to be spurious, since any such details would be alien to the general tenor of the work, as well as opposed to the express statement of the prooemium.

INTRODUCTION

A. H. Baumgärtner : *Onosanders Unterricht eines Feldherrn, übersetzt und mit Anmerkungen erläutert; in Vollständige Sammlung aller Kriegsschriftsteller der Griechen.* Mannheim, 1777,¹ and separately in 1786. This is said to be a poor piece of work, based on Schwebel's text.

French

Jehan Charrier : *L'art de la guerre composé par Nicolas Machiavelli; l'état aussi et charge d'un lieutenant général d'armée, par Onosander, ancien philosophe platonique . . .*, Paris, 1546.²

Blaise de Vigenère : *L'art militaire d'Onosander, auteur grec, où il traite de l'office et devoir d'un bon chef de guerre, etc.*, Paris, 1605. The translation seems to have been completed in 1593, but was not published until after the author's death (Jähns, *op. cit.*, 93). The commentary and essays were so extensive as to make the whole work extremely bulky.³ It was by means of this translation that Prinz Moritz von Sachsen made his acquaintance with Onasander (Zur-Lauben, preface, 5).

Baron de Zur-Lauben : *Le général d'armée, par*

¹ Jähns, *op. cit.*, 94, gives the place of publication as Frankfurt and the date as 1779 (on p. 10, Frankenthal and München). This may have been a different edition but it is more likely that we have here only a different title-page.

² The catalogue of the Bibl. Nat. indicates that there were other editions of this translation, but the volume which would contain them has not yet appeared. The Brit. Mus. possesses only this edition of 1546.

³ Max Jähns, *op. cit.*, speaks of 1500 pages, but the Brit. Mus. cat records only 734. The book is a quarto.

ONASANDER

Onosander. Ouvrage traduit du Grec, etc. Paris, 1754 and 1757. The reprint of 1757 is bound with Schwebel's edition of 1762. Another edition appeared in vol. i. of Zur-Lauben's *Bibliothèque militaire historique et politique*, Cosmopolis [Paris], 1760. It was also reprinted by A. Koraes in his edition, Paris, 1822, *q.v.*

Charles Guischart¹: Les institutions d'Onosandre pour servir a l'instruction d'un général. Traduites du Grec. In his *Mémoires militaires sur les Grecs et les Romains*, vol. ii, 49-106. The Hague, 1757,² and Lyon, 1760. This translation was reprinted by Liskenne and Sauvan; see below.

[A. Koraes: Paris, 1822. See *Editions.*]

F. C. Liskenne et J. B. B. Sauvan: Bibliothèque historique et militaire. In eight vols. Paris, 1835-46; and 1851 ff. The translation of Onasander, by Guischart, is in vol. iii, 405-35.

Italian

Fabio Cotta: Onosandro platonico dell' ottimo capitano generale e del suo officio. Tradotto di Greco in lingua volgare Italiana. Venezia, 1546 and 1548. This work was translated into English by Peter Whytehorne. It was republished by G. Daelli in *Biblioteca rara*, Milano, 1863, vol. jv.

¹ Thus Haase: 1835, 98, and the catalogues of the Brit. Mus. and the Bibl. Nat.; Guischart, Fabricius, *op. cit.*, 339, Brunet, Graesse; Guischart, Jähns, *op. cit.*, 93.

² Haase, *ibid.*, and the catalogues of the Brit. Mus. and the Bibl. Nat. give 1758.

INTRODUCTION

English

Peter Whytehorne : Onosandro Platonico, of the generall captaine and of his office, translated out of Greke into Italyan by Fabio Cotta. a Romaine ; and out of Italyan into Englysh by Peter Whytehorne. London, 1563.

Modern Greek

G. Apostolos Skalasteras : Bucharest, 1832. M. Konstantiniades (see next item) claims that this version was not made from the original Greek, but only from a translation.

Michael Konstantiniades : Ὀνησάνδρου Στρατηγικός, μεταφρασθεὶς ἐκ τῆς ἀρχαίας εἰς τὴν καθ' ἡμᾶς Ἑλληνικήν. Athens, 1897.

CRITICISM

Anon. : *Acta litteraria*, vol. i, part I, 22-8 ; *Nova acta erudita*, 1763, 201-11 ; *ibid.*, 1768, 313-19. The last two articles are devoted to a critique of Schwebel's edition. The first is not accessible to me.

H. Delbrück : *Geschichte der Kriegskunst im Rahmen der politischen Geschichte*. Berlin, 1921, vol. ii, 200.

Christ - Schmid - Stählin : *Griechische Literaturgeschichte*, 6th ed., München, 1921, vol. ii, 422.

Th. Crenius : *De eruditione comparanda*. Leyden, 1699, 470, 570 ff. Crenius seems to have

ONASANDER

added some observations of his own to the work of Naudaeus which he republished. See Schwebel, pref. [10].

J. A. Fabricius: *Bibliotheca Graeca*. Leipzig, 1795, vol. iv, 336-40.

Fr. Haase: "Über die griechischen und lateinischen Kriegsschriftsteller," *Jahrb. für Philol.*, 1835, 14: 86-118.

De militarium scriptorum Graecorum et Latinorum omnium editione instituenda. Berlin, 1847.

M. Haupt: *Varia* (including a brief note on Onasander). *Hermes*, 1871, 5: 175. Reprinted in *Opuscula*, 1876, vol. iii, 518 f.

Max Jähns: *Geschichte der Kriegswissenschaften*, etc., München und Leipzig, 1889, vol. i, 5-10; 90-94.

Herman Köchly: *Index lectionum in literarum universitate*. Zürich, 1854. A discussion of mss. of Onasander, principally Bern. 97 and Paris. 2522.

H. Köchly and W. Rüstow: *Griechische Kriegsschriftsteller*, Leipzig, 1855, vol. ii, 1, 84 f.

K. K. Müller: "Ein griechisches Fragment über Kriegswesen," in *Festschrift für L. Urlichs*, Würzburg, 1880, 106-38. On the Laurentian ms. of Onasander.

"Eine griechische Schrift über Seekrieg", in *Festgabe zur dritten Säcularfeier der Universität Würzburg*, Würzburg, 1882. On the general classification of the mss.

Gabr. Naudaeus: *Syntagma de studio militari*. Rome, 1637. Republished as *Naudaei bibliographia militaris*, Jena, 1683, and included in Thomas Crenius, *De eruditione comparanda*, Leyden, 1699.

G. Rathgeber: Article "Onosandros," in Ersch

INTRODUCTION

and Grüber's *Encyklopädie der Wissenschaften und Künste*, series III, vol. iv, 9-12.

H. von Rohden: "Quas rationes in hiatu vitando scriptor de sublimitate et Onesander secuti sint," in *Commentationes in honorem F. Bücheleri et H. Useneri*. . . . Bonn, 1873, 68-94.

Cl. Salmasius: *De re militari Romanorum*, Leyden, 1657. Republished in J. G. Graevius: *Thesaurus antiquitatum Romanarum*. For Onasander see vol. x, 1389.

MANUSCRIPTS

The mss. of Onasander are much more numerous than those of the other Greek military writers, and thus testify to his abiding influence throughout antiquity, but only a few of them, and these mainly copies from existing codices, have ever been collated, and two of the very oldest seem not to have been used at all prior to this edition.¹ As K. K. Müller has observed (*Festgabe, etc.*), the ms. tradition of Greek military authors falls into three main groups, the first of which is composed of the Florentinus LV. 4, s. X, and its descendants (especially A and B, see below); the second, of the Parisinus 2442, s. XI, the Vaticanus Graecus 1104, s. XI, and the

¹ Most of them are listed by Zur-Lauben in the preface to his translation (from Montfaucon, *Bibl. Bibl.*); Haase, *De milit. script. Gr.*; and K. K. Müller, *Festgabe zur dritten Säcularfeier*. Add to those mentioned in these works one at Perugia (Blume, *Bibliotheca librorum mss. Italica*, in *Supplementum itineris Italici*, Göttingen, 1834, 122), and another at Turin (Fabricius, *Bibl. Graeca*, iv (1795), 337).

ONASANDER

Neapolitanus III C 26, s. XI, and their descendants (*e.g.*, M and Vat. 2201 are direct copies of the Vaticanus) or closely related mss.; the third, of the Ambrosianus 139 (old no. B 119), s. X (or XI according to an older dating).

The Florentinus is incomparably the best ms. for Onasander, so that the disagreements of other mss. need be considered only in the relatively few passages where it has obviously suffered from corruption. Mss. A and B are faithful copies of the Florentinus, and Köchly collated these two mss. himself, so that this branch of the tradition was fairly well known even before the collation of the parent ms. In view of this fact and of the rare critical acumen of Köchly it is but natural that the present edition will be found to differ in only a few places, and generally in points of minor importance (but uniformly along the line of closer adherence to the Florentinus), from the text as constituted by that great scholar.

The second family represents a markedly inferior text, but probably one of wider circulation, and so presumably the vulgate of Leo's time. It is valuable primarily only when the Florentinus is corrupt. I have given, however, in the *apparatus criticus* all the important variations of the three leading mss. of this family from the printed text, so that the material upon which a judgement must be based may not be withheld from others.

The third group, represented by the Ambrosianus, gives us a text varying so widely from that of the other lines of tradition that both K. K. Müller and the editors of the catalogue of the Ambrosian Library, Drs. Martini and Bassi, regard it as no

INTRODUCTION

longer a recension but as a Byzantine paraphrase. I have taken, therefore, no cognizance of it, not, of course, because I am unaware of the value which a close paraphrase like this, and even a much freer one like that of many passages in Leo's *Tactica*, have in attesting the direct ms. tradition, but merely because it has been impossible in the time available, because of the delay and uncertainty of communication with Italy, to secure photographs of the Ambrosianus and present this secondary material in a form suitable for a volume of this series.¹

To sum up: we have in F' an excellent, old, uninterpolated, but not faultless text; in PGH and most other mss. a Byzantine vulgate; in the Ambrosianus 139 a Byzantine paraphrase; in Leo a Byzantine plagiarism.

¹ Similarly, in the case of Leo, it has been impossible to secure from Hungary the new critical edition of the *Tactica* prepared by Dr. R. Vári, and published by the Budapest Academy as long ago as 1917, while any extensive use of this work in the old editions would be unprofitable. It should be noted, however, that Leo agrees occasionally with F' against all other mss., which would suggest that the tradition represented by F' and not the vulgate was the basis of his paraphrase, a condition apparently somewhat different from that which Wescher, *Poliorcétique grecque*, p. xxxix, presupposes for the tradition of the military technicians.

ONASANDER

SYMBOLS

I give here, in addition to the symbols for the four great mss., those used by Köchly for the mss. from which readings were given by his predecessors. The names Rigaltius, Schwebel, Koraes, and Köchly in the *apparatus* refer to the texts, or notes as the case may be, and those of Sagundinus and Camerarius, to the translations produced respectively by these scholars.

A Parisinus 2522, s. XV, a copy of F. The corrector, A m², is derived from R, or a very closely related ms. (Köchly.)

B Bernensis 97, s. XV-XVI, a copy of F but with some emendations. (Köchly.)

C Morellanus, once in the possession of F. Morellus at Paris. It seems to be descended from F but has many deviations and peculiar readings. (Rigaltius.)

D An inferior sixteenth century ms. (Koraes.)

E In the library at Munich in the eighteenth century; it agrees closely with the late mss. of Rigaltius. (Schwebel.)

F Florentinus LV. 4, s. X, collated by Prof. Dott. Enrico Rostagno for this edition. The symbol F is used by Köchly for a very few readings from a Florentine ms. (presumably LV. 4) furnished Schwebel by Dom. Mar. Manni. For these the designation "F (*sic*)" is used.

G Vaticanus Graecus 1164, s. XI. See H. Photographs of this ms. were used. Two leaves are missing (for details see *apparatus* on 10. 27 and 35. 3). Some portions, especially of

INTRODUCTION

- fol. 11^r, are illegible. For a description see Wescher, *Poliorcétique grecque*, pp. xxiv ff.
- H Neapolitanus III C 26, s. XI. H and G agree so closely that they are certainly copies of the same archetype, probably uncial. Photographs of this ms. were used.
- K A late and inferior ms. owned by Koraes. (Koraes.)
- M "Cod. Medicus, ex Bibl. Reg. Catharinae", a direct copy of G. (Rigaltius.)
- N A late ms. owned by Joh. Nagel, agreeing generally with the late mss. of Rigaltius. (Schwebel.)
- P Parisinus 2442, s. XI, collated for Köchly by Jakob Huntziker. For a description see Wescher, *Poliorcétique grecque*, pp. xxvi f. (Köchly.)
- R A late and extensively interpolated ms. of Rigaltius, the probable source of the readings of the second hand of A. (Rigaltius.)
- V "Vet. Membranae" or "Vetusta Macrocola," seldom reported upon. (Rigaltius.)
- v Vulgate reading of the mss. used by Köchly and his predecessors. With this A m² (although Köchly quotes the latter separately) nearly always agrees, and when it does so is included under that symbol. Because of its age and importance P is cited separately, even if agreeing with v, when specially reported by Köchly.
- Ω All mss. or all other mss. (including FGH).

NOTE.—The quoted phrases "alii codd. ut vid.", "ceteri codd. ut vid.", etc., are taken from Köchly's *apparatus* (based upon inferences from the earlier editions), unless some other authority is cited.

ΟΝΑΣΑΝΔΡΟΥ¹

ΣΤΡΑΤΗΓΙΚΟΣ

ΠΡΟΟΙΜΙΟΝ

Ἰππικῶν μὲν λόγων ἢ κυνηγετικῶν ἢ ἀλιευτικῶν τε αὖ καὶ γεωργικῶν συνταγμάτων προσφώνησιν ἡγοῦμαι πρέπει² ἀνθρώποις, οἷς πόθος ἔχουσι τοιῶνδε ἔργων, στρατηγικῆς δὲ περὶ θεωρίας, ᾧ Κόϊντε Οὐηράνιε, Ῥωμαίοις καὶ μάλιστα Ῥωμαίων τοῖς τὴν συγκλητικὴν ἀριστοκρατίαν λελογχόσι³ καὶ κατὰ τὴν Σεβαστοῦ Καίσαρος ἐπιφροσύνην ταῖς⁴ τε ὑπάτοις καὶ στρατηγικαῖς ἐξουσίαις κοσμουμένοις⁵ διὰ τε παιδείαν, ἧς οὐκ ἐπ' ὀλίγον ἔχουσιν ἐμπειρίαν, καὶ προγόνων
² ἀξίωσιν. ἀνέθηκα δὲ πρώτοις σφίσι⁶ τόνδε τὸν λόγον οὐχ ὡς ἀπίροις⁷ στρατηγίας, ἀλλὰ μάλιστα τῆδε θαρρήσας, ἧ⁸ τὸ μὲν ἀμαθὲς τῆς ψυχῆς καὶ τὸ⁹ παρ' ἄλλῳ κατορθούμενον ἠγνόησεν, τὸ δὲ ἐν ἐπιστήμῃ τῷ καλῶς ἔχοντι προσεμαρτύρησεν.
³ ὅθεν, εἰ καὶ παρὰ πολλοῖς φανεῖη νενοημένα τὰ παρ' ἐμοῦ συντεταγμένα, καὶ κατὰ τοῦτο ἀνῆσθαι, ὅτι μὴ μόνον στρατηγικὰς συντεταξάμην

¹ F (subscr.): Ὀνησάνδρου D: Ὀνοσάνδρου Ω. See Introd.

² πρέπει GH.

³ λελογχῶσιν GH.

ONASANDER

THE GENERAL

PROOEMIUM

It is fitting, I believe, to dedicate monographs on horsemanship, or hunting, or fishing, or farming, to men who are devoted to such pursuits, but a treatise on military science, Quintus Veranius, should be dedicated to Romans, and especially to those of the Romans who have attained senatorial dignity, and who through the wisdom of Augustus Caesar have been raised to the power of consul or general, both by reason of their military training (in which they have had no brief experience) and because of the distinction of their ancestors. I have dedicated this treatise primarily to them, not as to men unskilled in generalship, but with especial confidence in this fact, that the ignorant soul is unaware even of that in which another is successful, but knowledge bears additional witness to that which is well done. For this reason, if what I have composed should seem to have been already devised by many others, even then I should be pleased, because I have not only

⁴ Koraes : τοῖς vH (G illeg.).

⁵ Corrected from -νης P.

⁶ ENR : φησι GHP.

⁷ ἀπειρος P.

⁸ EN : ἡ GHP.

⁹ Added by Köchly (G illeg.).

ONASANDER

ὑφηγήσεις, ἀλλὰ καὶ στρατηγικῆς ἐστοχασάμην καὶ τῆς ἐν αὐτοῖς φρονήσεως, εὐτυχοίην τ' ἄν, εἰ, ἃ δὴ Ῥωμαίοις δυνάμει καὶ δι' ἔργων πέπρακται,¹ ταῦτ' ἐγὼ λόγῳ περιλαβεῖν² ἱκανὸς εἶναι παρὰ³ τοιούτοις ἀνδράσι δοκιμασθεῖην.

- 4 Τὸ δὲ σύνταγμα θαρροῦντί μοι λοιπὸν εἶπεῖν ὡς στρατηγῶν τε ἀγαθῶν ἄσκησις ἔσται παλαιῶν τε ἡγεμόνων κατὰ τὴν σεβαστὴν εἰρήνην ἀνάθημα, εἰσόμεθά τε καὶ εἰ μηδὲν ἄλλο, παρ' ἣν αἰτίαν οἱ τε πταίσαντες ἐσφάλησαν τῶν στρατηγησάντων, οἳ τε εὐπραγήσαντες ἐγέρθησαν⁴ εἰς δόξαν· μάλιστα δὲ τὴν Ῥωμαίων ἀρετὴν ἐννοήσομεν, ὡς οὔτε βασιλεὺς οὔτε πόλις οὔτε ἔθνος μείζον ἡγεμονίας ἐκρατύνατο μέγεθος, ἀλλ' οὐδ' εἰς ἴσον ἤλασεν,⁵ ὥστε τοσοῦτοις βεβαιώσασθαι χρόνοις ἀκίνητον δυνα-
- 5 στεῖαν. οὐ γὰρ τύχη μοι δοκοῦσιν ὑπεράραντες τοὺς τῆς Ἰταλίας ὄρους ἐπὶ πέρατα γῆς ἐκτεῖναι τὴν σφετέραν ἀρχήν, ἀλλὰ πράξειςι στρατηγικαῖς. συνεπιλαμβάνεσθαι μὲν γὰρ εὐχεσθαι δεῖ καὶ τὴν τύχην, οὐ μὴν τὸ παράπαν οἶεσθαι ταύτην κρατεῖν.
- 6 ἀλλ' ἀνόητοι⁶ οἱ καὶ τὰ σφάλματα⁷ τῆς τύχης ἐγκλήματα μόνης ποιούμενοι,⁸ οὐ τῆς τῶν στρατηγούντων ἀμελείας, καὶ τὰ κατορθώματα ταύτης,⁹ οὐ τῆς ἐμπειρίας τῶν ἡγουμένων· οὔτε γὰρ ἐπιεικὲς ἀνεπιτίμητον οὕτως ἀπολιπεῖν¹⁰ τὸν πταίοντα τοῖς ὄλοις, ὡς πάντων αἰτιᾶσθαι τὴν τύχην, οὔτε δίκαιον ἀμάρτυρον ἐπὶ τοσοῦτον ἐπαίνου τὸν

¹ Kitchly : πραξαί Ω (πρα///// G : πράξαι H).

² GH : περιβαλεῖν v.

³ Kitchly : εἶναι δόξαιμι· εἰ δὴ παρὰ Ω.

⁴ ἐγέρθησαν P : ἠέρθησαν Kitchly.

⁵ ἤλασαν P.

⁶ ἀλλ' ἀνόητοι (the breathing over the second a changed to an accent) H : ἀνόητος von Rohden.

THE GENERAL, PROOEMIUM 3 - 6

compiled precepts of generalship, but have also endeavoured to get at the art of the general and the wisdom that inheres in the precepts. I should be fortunate if I should be considered capable, before such men, of making a summary sketch of what the Romans have already accomplished by their mighty deeds.

It remains for me to say with good courage of my work, that it will be a school for good generals, and an object of delight for retired commanders in these times of holy peace; and we shall know, if nothing else, for what reason some generals have stumbled and fallen, but others have prospered and been raised to fame; and we shall consider above all the valour of the Romans, how that neither king, nor state, nor nation has held a greater position of leadership, nor even equalled them in the establishment of a dominion, unshaken through so many years. For it is not by chance, as it seems to me, that they have overrun the boundaries of Italy and extended their sway to the limits of the earth, but by deeds of generalship. For it is necessary to pray to Fortune to do its share, but not to consider that Fortune has entire control. Stupid are those who make disasters chargeable to Fortune alone, rather than to the negligence of commanders, as well as those who attribute successes to her, and not to the skill of the generals. It is neither reasonable simply to dismiss without punishment a general who has met with complete disaster, on the ground that Fortune is responsible for all things, nor is it just to

⁷ σφάλματα G: σφάλματα H. ⁸ ποιούμενας von Rohden.

⁹ With this word F (and its copies A and B) begins.

¹⁰ ἀπολείπειν v.

ONASANDER

κατορθούντα περιορᾶν, ἐφ' ὅσον ἀπάντων ἀνατιθέναι τῇ τύχῃ τὴν χάριν.

- 7 Ἐπειδὴ δὲ φύσει πάντες ἄνθρωποι τοῖς μὲν δι' ἐμπειρίας συντετάχθαι δοκοῦσι, κἂν ἀσθενῶς ἀπαγγέλληται,¹ τὸ πιστὸν εἰς ἀλήθειαν ἀπονεμουσιν, τοῖς δὲ ἀπίροις,² κἂν ἢ δυνατὰ³πραχθῆναι, διὰ τὸ ἀδοκίμαστον ἀπιστοῦσιν, ἀναγκαῖον ἡγοῦμαι περὶ τῶν ἐν τῷδε τῷ λόγῳ στρατηγημάτων ἡθροισμένων τοσοῦτο⁴ προειπεῖν, ὅτι πάντα διὰ πείρας ἔργων ἐλήλυθεν καὶ ὑπὸ ἀνδρῶν τοιούτων, ὧν ἀπόγονον ὑπάρχει Ῥωμαίων ἅπαν τὸ γένει καὶ ἀρετῇ⁵ μέχρι τοῦ δεῦρο πρωτεῦον. οὐθὲν γὰρ ἐσχεδιασμένον ἀπολέμῳ καὶ νεωτέρα γνώμη τόδε περιέχει τὸ σύνταγμα, ἀλλὰ πάντα διὰ πράξεων καὶ ἀληθινῶν ἀγώνων κεχωρηκότα μάλιστα μὲν⁶ Ῥωμαίοις· ἃ τε γὰρ ποιήσαντες⁷ ἐφύλαξαν⁸ παθεῖν καὶ δι' ὧν ἐμηχανήσαντο⁹ δρᾶσαι, πάντα μοι συνείλεκται. καίτοι οὐκ¹⁰ ἠγνόηκα, ὅτι μᾶλλον ἂν τις εἴλετο¹¹ πάνθ' ἑαυτοῦ καὶ τῆς ἰδίας ἀγχινῶας τὰ στρατηγήματα δοκεῖν εἶναι, πλείονα θηρώμενος ἔπαινον τῶν πιστευσάντων, ἢ ἀπὸ¹² τῆς ἀλλοτρίας ἐπινοίας· ἐγὼ δὲ οὐ παρὰ τοῦτ' ἐλαττοῦσθαι δοκῶ. καθάπερ γάρ,¹³ εἴ τις ἐν πολέμοις αὐτὸς στρατευσάμενος¹⁴ συντετάξατο τοιόνδε λόγον, οὐκ ἂν παρὰ τοῦτο ἤττονος ἡξιούτο μαρτυρίας, ὅτι μὴ μόνον φυσικῆς

¹ ἀπαγγέλληται GH.

² ἀπειράτοις GH Koracs.

³ εἰ δύναται GHv.

⁴ τοσοῦτον GHv.

⁵ τῷ γένει καὶ ἀρετῇ v: τῷ γένει· καὶ ἀρετῇ GH.

⁶ Oia. vGH Kschly.

⁷ πολεμήσαντες Köchly.

⁸ ἐφύλαξαν τὸ P.

⁹ ἐμαχήσαντο GH: δίκαιον ἐμαχήσαντο EF'(sic)N "aliquie codd." (Schwebel) A m².

THE GENERAL, PROOEMIUM 6 - 10

leave the successful general so far without recognition that gratitude for everything is offered to Fortune.

Now since all men naturally give credit for truthfulness to those who appear to write with professional experience, even though their style be feeble, while for inexperienced writers, even though their teachings are practicable, they feel distrust on account of their lack of reputation, I consider it necessary to say in advance, about the military principles collected in this book, that they have all been derived from experience of actual deeds, and, in fact, of exploits performed by those men from whom has been derived the whole primacy of the Romans, in race and valour, down to the present time. For this treatise presents no impromptu invention of an unwarlike and youthful mind, but all the principles are taken from authentic exploits and battles, especially of the Romans. For the expedients they used in order to avoid suffering harm, and the means by which they contrived to inflict it, all this I have collected. Nor have I failed to perceive that a writer, seeking greater praise from credulous readers, would prefer to have it appear that the source of all the military stratagems he described was himself and his own shrewdness rather than the sagacity of others. But I do not think that the latter diminishes one's glory. For if a general after experience in the field had composed such a work, it would not be considered of less value because he introduced and commemorated in his

¹⁰ γ' von Rohden.

¹¹ εἴλατο GHA m².

¹² Köchly: ἀπὸ τῶν πιστευσάντων ἢ τῆς Γ': ἀπὸ τ. π. ἢ ἀπὸ τῆς vGH.

¹³ OIII. v.

¹⁴ αὐτοστρατευσάμενος vGH.

ONASANDER

ἀγχινοίας ἰδίαν εὕρεσιν εἰσηνέγκατο στρατηγημάτων, ἀλλὰ καὶ τὰ δι' ἄλλων εὖ πραχθέντα μνήμη παραθέμειος εἰς σύνταξιν ἤγαγεν, οὕτως οὐδ' ἔμαντὸν οἶομαι τοῦλαττον ἐπαίνων οἶσεσθαι παρὰ τοῦθ', ὅτι μὴ πάντα τῆς ἐμῆς ὁμολογῶ συνέσεως εἶναι,¹ τούναντίον δὲ προεἶληφα τὸν τ' ἐπαινον ἀνεπίφθονον ἔξειν καὶ τὴν πίστιν ἀσυκοφάντητον.

I. [Περὶ αἰρέσεως στρατηγοῦ²]

Φημὶ τοίνυν αἰρεῖσθαι τὸν στρατηγὸν οὐ κατὰ γένη κρίνοντας, ὥσπερ τοὺς ἱερέας, οὐδὲ κατ' οὐσίας, ὡς τοὺς γυμνασιάρχους,³ ἀλλὰ σώφρονα, ἐγκρατῆ, νήπτην, λιτόν, διάπονον, νοερόν, ἀφιλάργυρον, μῆτε νέον μῆτε πρεσβύτερον, ἂν τύχη καὶ πατέρα παίδων, ἰκανὸν λέγειν, ἔνδοξον.

2 [α']⁴ σώφρονα μὲν, ἵνα μὴ⁵ ταῖς φυσικαῖς ἀνθελκόμενος ἡδοναῖς ἀπολείπη τὴν ὑπὲρ τῶν μεγίστων φροντίδα.

3 [β'] ἐγκρατῆ δέ, ἐπειδὴ⁶ τηλικαύτης ἀρχῆς μέλλει τυγχάνειν· αἱ γὰρ ἀκρατεῖς⁷ ὄρμαι προσλαβοῦσαι τὴν τοῦ δύνασθαί τι¹ ποιεῖν ἐξουσίαν ἀκατάσχετοι γίνονται πρὸς τὰς ἐπιθυμίας.

¹ Om. vGH.

² Not in FGH. F has no indication of any break between the prooemium and the first chapter, but only after § 1 of the chapter. GH have in the body of the text ἀρχὴ τοῦ στρατηγικοῦ. All the titles date from different periods subsequent to the original composition; that of Chap. ix, because of ἀπληκτα, castra, must be assigned to Byzantine times.

³ γυμνασιάρχας A m³ vGH.

⁴ These marginal paragraph letters are not in F but they appear in GH (and apparently most of the later mss., to 374

work, not only the personal discoveries of his native wit, but also the brilliant deeds of other generals; in the same way I do not consider that I myself shall win less praise, because I admit that not everything I write springs from my own intelligence. On the contrary, I have chosen the opposite course, that I may have praise without reproach and trust without slander.

I. [*The Choice of a General*]

I believe, then, that we must choose a general, not because of noble birth as priests are chosen, nor because of wealth as the superintendents of the gymnasia, but because he is temperate, self-restrained, vigilant, frugal, hardened to labour, alert, free from avarice, neither too young nor too old, indeed a father of children if possible, a ready speaker, and a man with a good reputation.

The general must be temperate in order that he may not be so distracted by the pleasures of the body as to neglect the consideration of matters of the highest importance.

He must be self-restrained, since he is to be a man of so great authority; for the licentious impulses, when combined with the authority which confers the power of action, become uncontrollable in the gratification of the passions.

judge from the silence of Köchly). In F the first line of each subdivision begins with a red letter, and in nearly every instance an interval is left between each pair of subdivisions.

⁵ ταῖς φυσικαῖς μὴ vGH.

⁶ ἐπει vGH.

⁷ ἐγκρατεῖς corr. to ἀκρατεῖς P.

ONASANDER

- 4 [γ'] νήπτην δ', ὅπως ἐπαγρυπνῆ ταῖς μεγίσταις πράξεσιν· ἐν νυκτὶ γὰρ ὡς τὰ πολλὰ ψυχῆς ἡρεμούσης στρατηγοῦ γνώμη τελειοῦται.
- 5 [δ'] λιτὸν δέ, ἐπειδὴ κατασκελετεύουσιν¹ αἱ πολυτελεῖς θεραπείαι δαπανῶσαι χρόνον ἄπρακτον εἰς τὴν τῶν ἡγουμένων τρυφήν.
- 6 [ε'] διάπονον δ', ἵνα μὴ πρῶτος τῶν στρατευομένων, ἀλλ' ὕστατος² κάμνη.
- 7 [ς'] νοερὸν δέ·³ ὄξυν γὰρ εἶναι δεῖ τὸν στρατηγὸν ἐπὶ πᾶν ἄττοντα δι' ὠκύτητος ψυχῆς κατὰ τὸν Ὀμηρον

ὡσεὶ πτερὸν ἠὲ νόημα.⁴

πολλάκις γὰρ ἀπρόληπτοι⁵ ταραχαὶ προσπεσοῦσαι σχεδιάζειν ἀναγκάζουσι τὸ συμφέρον.

- 8 [ζ'] ἀφιλάργυρον δέ· ἢ γὰρ⁶ ἀφιλαργυρία δοκιμασθήσεται καὶ πρώτη· τοῦ γὰρ ἀδωροδοκίτης καὶ μεγαλοφρόνως προϊστασθαι τῶν πραγμάτων αὐτῆ⁷ παραίτια· πολλοὶ γάρ, κἂν διὰ⁸ τὴν ἀνδρίαν ἀσπίσι πολλαῖς καὶ δόρασιν ἀντιβλέψωσιν, περὶ τὸν χρυσὸν ἀμαυροῦνται· δεινὸν γὰρ πολεμίοις ὄπλον τοῦτο καὶ δραστήριον εἰς τὸ νικᾶν.
- 9 [η'] οὔτε δὲ νέον οὔτε πρεσβύτερον, ἐπειδὴ ὁ μὲν ἄπιστος,⁸ ὁ δ' ἀσθενής·⁹ οὐδέτερος γὰρ¹⁰ ἀσφαλής, ὁ μὲν νέος, ἵνα μὴ τι¹¹ διὰ τὴν ἀλόγιστον πταίση τόλμαν, ὁ δὲ πρεσβύτερος, ἵνα μὴ τι¹²
- 10 διὰ τὴν φυσικὴν ἀσθένειαν ἐλλείπη.¹³ κρατίστη

¹ κατασκελετεῦσιν F.

² Köchly: ὕστερος FGHEN: ὕστερον P.

³ Om. F. ⁴ ἢ ἐννόημα GH. ⁵ ἀπροσδόκητοι vGH.

⁶ Schwebel supported by Leo, *Tactica*, ii. 8: συμφέρον· (interval) ἢ δ' ἀφιλαργυρία Ω.

⁷ αὐτῆ vGH.

⁸ Ω def. Koracs: ἀλόγιστος Köchly.

THE GENERAL, I. 4 - 10

Vigilant, that he may spend wakeful nights over the most important projects; for at night, as a rule, with the mind at rest, the general perfects his plans.

Frugal, since expensive attendance upon the luxurious tastes of commanders consumes time unprofitably and causes resources to waste away.

Hardened to labour, that he may not be the first but the last of the army to grow weary.

Alert, for the general must be quick, with swiftness of mind darting at every subject—quick, as Homer says, “as a bird, or as thought.”¹ For very frequently unexpected disorders arise which may compel him to decide on the spur of the moment what is expedient.

Free from avarice; for this quality of freedom from avarice will be valued most highly, since it is largely responsible for the incorruptible and large-minded management of affairs. For many who can face the shields and spears of a host with courage are blinded by gold; but gold is a strong weapon against the enemy and effective for victory.²

Neither too young nor too old; since the young man does not inspire confidence, the old man is feeble, and neither is free from danger, the young man lest he err through reckless daring, the older lest he neglect something through physical weakness. The ideal lies between the two, for physical

¹ *Odyssey*, vii. 36.

² The Romans of this period enjoyed among the Greeks a singularly evil reputation for greed; see especially a striking passage in Diodorus Siculus xxxi. 26.

⁹ ἐπειδή . . . ἀσθενής del. von Rohden.

¹⁰ δὲ Koraes (δ' Köchly): οὐδ' ἔτιμος F(GH).

¹¹ Om. vGH.

¹² B: om. Ω.

¹³ ἑλλητη Koraes.

THE GENERAL, i. 10 - 13

vigour is found in the man who has not yet grown old, and discretion in the man who is not too young. Those who value physical strength without discretion, or discretion without physical strength, have failed to accomplish anything. For a weak mind can contribute no valuable ideas, nor can strength unsupported bring to completion any activity. Moreover, a man of good reputation is of no slight assistance to those who choose him; for if men have a spontaneous and natural love for their general, they are quick to obey his commands, they do not distrust him, and they coöperate with him in case of danger.

I should prefer our general to be a father, though I would not refuse a childless man, provided he be a good man. For if he happens to have young children, they are potent spells to keep his heart loyal, availing to bind him to the fatherland, a powerful and keen incentive to a father, capable of arousing his heart against the foe. And should his children have reached manhood, they will become advisers and aides, faithful guardians of his secrets, and they will help him to bring the affairs of state to a successful issue.

A ready speaker¹; for I believe that the greatest benefit can accrue from the work of a general only through this gift. For if a general is drawing up his

¹ Thus Homer felt that the great leader must be *μύθων τε ῥητῆρ' ἔμεναι προκτῆρὰ τε ἔργων* (*Iliad*, ix. 443), and the harangue before battle was a necessary formality, which a Cæsar felt must be delivered even to his tenth legion and in the crisis of the unexpected attack of the Nervii (*Bellum Gallicum*, ii. 21. 1 f.). Compare also Cicero, *Philippica*, iv. 5.

ONASANDER

- λόγου παρακέλευσις τῶν μὲν δεινῶν ἐποίησε καταφρονεῖν, τῶν δὲ καλῶν ἐπιθυμεῖν, καὶ οὐχ οὕτως ἀκοαῖς ἐνηχοῦσα σάλπιγξ ἐγείρει ψυχὰς εἰς ἄμιλλαν μάχης, ὡς λόγος εἰς προτροπὴν ἀρετῆς ἐναγωνίου¹ ῥηθεῖς αἰχμάζουσας² ἀνέστησε πρὸς τὰ δεινὰ τὴν διάνοιαν, ἂν τέ τι³ συμβῆ πταῖσμα περὶ τὸ στρατόπεδον, ἢ τοῦ λόγου παρηγορία τὰς ψυχὰς ἀνέρρωσε, καὶ πολὺ δὴ χρησιμώτερός ἐστι στρατηγοῦ λόγος οὐκ ἀδύνατος ὥστε παραμυθεῖσθαι τὰς ἐν στρατοπέδοις⁴ συμφοράς, τῶν ἐπομένων
- 14 τοῖς τραυματίαις ἰατρῶν· οἱ⁵ μὲν γὰρ ἐκείνους μόνους⁶ τοῖς φαρμάκοις θεραπεύουσιν, ὁ δὲ καὶ τοὺς κάμνοντας εὐθυμοτέρους ἐποίησεν καὶ τοὺς
- 15 ἐρρωμένους ἀνέστησε.⁷ καὶ ὥσπερ τὰ ἀόρατα νοσήματα τῶν ὀρωμένων δυσχερεστέραν ἔχει τὴν θεραπείαν, οὕτως ψυχὰς ἐξ ἀθυμίας ἰάσασθαι λόγῳ παρηγορήσαντα δυσκολώτερον, ἢ σωματῶν
- 16 φανεράν ἐξ ἐπιπολῆς⁸ θεραπεῦσαι⁹ νόσον. οὐδὲ χωρὶς στρατηγῶν¹⁰ οὐδὲ μία¹¹ πόλις ἐκπέμψει στρατόπεδον, οὐδὲ δίχα τοῦ δύνασθαι λέγειν αἰρήσεται στρατηγόν.
- 17 [ια'] τὸν¹² δὲ ἐνδοξον, ὅτι τοῖς ἀδόξοις ἀσχάλλει τὸ πλῆθος ὑποταττόμενον· οὐθεῖς¹³ γὰρ ἐκῶν ὑπομένει τὸν αὐτοῦ¹⁴ χείρονα κύριον ἀναδέχεσθαι
- 18 καὶ ἡγεμόνα. πᾶσα δὲ ἀνάγκη τὸν τοιοῦτον

¹ ἐν ἀγωνί vGH.

² Om. vGH.

³ ἰατρῶν μὲν F.

⁴ ἐν στρατοπέδοις vGH.

⁵ ἀκμάζουσας vGH.

⁶ τοῖς στρατ. vGH.

⁷ μόνους PR.

⁸ Köchly's suggestion that the order might be τοὺς κάμνοντας ἀνέστησε καὶ τοὺς ἐρρωμένους εὐθυμοτέρους ἐποίησεν perhaps derives some support from F's forms ἐποίησεν and ἀνέστησε, but Leo, *Tactica*, ii. 14, as Köchly himself observed, had clearly the present order in the text before him.

THE GENERAL, I. 13 – 18

men before battle, the encouragement of his words makes them despise the danger and covet the honour; and a trumpet-call resounding in the ears does not so effectively awaken the soul to the conflict of battle as a speech that urges to strenuous valour rouses the martial spirit to confront danger. Should some disaster befall the army, an encouraging speech will give the men's souls new strength; and a not unskilful address by the commander is far more useful in counteracting the despondency of an army in the hour of defeat than the physicians who attend to the wounded. For the physicians with their medicines care only for the wounded, whereas the eloquent general not only heartens the disabled but also sets the well on their feet again. Just as hidden diseases are harder to cure than those with external symptoms, so it is more difficult by a consoling speech to cure a heart of its despondency than to minister to an obvious and manifest disease of the body. No city at all will put an army in the field without generals nor choose a general who lacks the ability to make an effective speech.

The general should be a man of good reputation, because the majority of men, when placed under the command of unknown generals, feel uneasy. For no one voluntarily submits to a leader or an officer who is an inferior man to himself. It is absolutely

⁸ ἐπιπολλῆς P: ἐπιστολῆς (in marg. γρ. ἐπιπολλῆς) GH.

⁹ θεραπεύει GH: θεραπεύειν v.

¹⁰ στρατηγού Koraes and Köchly.

¹¹ FGH (though the testimony of GH on such a point is practically worthless): οὐδεμία Köchly.

¹² τὸ GH.

¹³ οὐδεὶς vH (οὐ δεῖς G).

¹⁴ αὐτοῦ F'GH.

ONASANDER

ὄντα καὶ τοσαύτας ἀρετὰς ἔχοντα ψυχῆς,¹ ὅσας εἴρηκα,² καὶ ἔνδοξον εἶναι.

- 19 Φημί δὲ μήτε τὸν πλούσιον, εἰάν ἐκτὸς ἦ τούτων, αἰρεῖσθαι στρατηγὸν διὰ τὰ χρήματα, μήτε τὸν πένητα, εἰάν ἀγαθὸς ἦ, παραιτεῖσθαι διὰ τὴν ἔνδειαν· οὐ μὴν χρή γε τὸν πένητα οὐδὲ τὸν πλούσιον, ἀλλὰ καὶ τὸν πλούσιον καὶ τὸν πένητα.³ οὐδ' ἕτερον⁴ γὰρ οὐθ' αἰρετόν⁵ οὐτ' ἀποδοκιμαστέον διὰ τὴν τύχην, ἀλλ' ἐλεγκτέον⁶ διὰ
- 20 τὸν τρόπον. οὐδέ⁷ πλούσιος ἀγαθὸς ὢν τοσοῦτῳ⁸ διοίσει τοῦ γενναίου πένητος, ὅσον αἱ ἐπάργυροι καὶ κατάχρυσοι πανοπλῖαι τῶν καταχάλκων καὶ σιδηρῶν—αἱ μὲν γὰρ⁹ τῷ κόσμῳ πλεονεκτοῦσιν, αἱ δ' αὐτῷ¹⁰ τῷ δραστηρίῳ διαγωνίζονται¹¹—, εἴ γε μὴ χρηματιστῆς εἴη.¹² τὸν δὲ χρηματιστήν, οὐδ' ἂν πλουσιώτατος ὢν τύχη,¹³ συμβουλευσῶ ποτὲ αἰρεῖσθαι· λέγω δὲ ὀβολοστάτην,¹⁴ μετάβολον, ἔμπορον ἢ τοὺς παραπλήσιόν τι τούτοις πράττοντας· ἀνάγκη γὰρ τοὺς τοιοῦτους μικρόφρονας εἶναι καὶ περὶ τὸ κέρδος ἐπτοημένους καὶ μεμεριμνημένους¹⁵ περὶ τὸν πορισμὸν τῶν χρημάτων ὄλως μηδὲν¹⁶ ἐσχηκέαι τῶν καλῶν ἐπιτηδευμάτων.
- 21 Προγόνων δέ¹⁷ λαμπρὰν¹⁸ ἀξίωσιν ἀγαπᾶν μὲν δεῖ προσοῦσαν, οὐ μὴν ἀποῦσαν ἐπιζητεῖν, οὐδὲ ταύτη¹⁹ τινὰς κρίνειν ἀξίους ἢ μὴ²⁰ τοῦ στρατηγεῖν,

¹ τῆς ψυχῆς B Köchly.

² εἴρηκε F.

³ καὶ τὸν πένητα οἰμ. F.

⁴ FGH Rigaltius Schwebel: οὐδέτερον Köchly.

⁵ F: αἰρετέον GH Köchly.

⁶ ἐλεγκτέον vGH.

⁷ ὁ δὲ FvGH: corr. AB (οὐ δὲ C: οὐκ δὲ R).

⁸ τοσοῦτον vGH.

⁹ After γὰρ vGH add καί.

¹⁰ After αὐτῷ vGH add μόνῳ.

¹¹ διαγωνίζονται GH.

¹² χρηματιστῆ εἴη F, which marks a break at this point.

¹³ ἂν τύχει F: ἂν τύχει R.

essential, then, that a general be such a man, of such excellent traits of character as I have enumerated, and besides this, that he have a good reputation.

A wealthy man in my opinion must not be chosen general on account of his wealth, if he has not these qualities; nor must a poor man, provided that he be competent, be rejected on account of his poverty. It is not necessary that the general be rich or poor; he may be the one or the other. Neither the one nor the other must be chosen nor rejected on account of his fortune in life, but must be tested by the standard of character. Even the wealthy general who is good will surpass the noble but poor general only in the same degree that armour inlaid with gold and silver surpasses that of bronze and iron—the former have the advantage in ornamentation but the latter prove superior in efficiency—provided that he is not a man who deals in money. Were he the richest man in the world, I should not ever advise choosing a man who deals in money. I mean by this expression a usurer, a trader, a merchant, or those who are in a similar business. For these men must have petty minds; excited over gain and worried about the means of getting money, they have acquired absolutely none of the noble habits of a general.

An illustrious family name we should welcome, if it be present, but if lacking it should not be demanded, nor should we judge men worthy or unworthy of commands simply by this criterion; but

¹⁴ ὀβολογιατήν RG (ὀβ-) H (ὀβ-) P (corr. to ὀβολοστάτην).

¹⁵ μεμορημένους GH.

¹⁷ Koræes: τε Ω.

¹⁹ οὐδ' ἐκ ταύτης vGH.

¹⁶ ὄλωσ δὲ μηδὲν GH.

¹⁸ λαμπρῶν Kœchly.

²⁰ Kœchly: εἰμή F: εἶναι vGH.

ONASANDER

ἀλλ' ὡσπερ τὰ ζῶα ἀπὸ τῶν ἰδίων πράξεων ἐξε-
 τάζομεν, ὅπως εὐγενείας ἔχει, οὕτω χρῆ σκοπεῖν
 22 καὶ τὴν τῶν ἀνθρώπων εὐγένειαν. καὶ γὰρ ἀ-
 περιόπτου,¹ τί τοῖς ἔμπροσθεν ἐπράχθη καλόν, ἐξ-
 ετάζειν, οὐ τί ποιήσουσιν οἱ νῦν αἰρεθέντες· ὡσπερ
 τῶν πάλαι γεγονότων σώζειν ἡμᾶς δυναμένων καὶ
 τὰ νῦν, καὶ² τὰ πρόσθεν τηρησόντων ἐκείνων. ἔτι
 δὲ πῶς³ οὐκ ἀπαίδευτον τοὺς μὲν στρατιώτας
 τοῖς ἀριστείοις τιμᾶν, οὐ τοὺς ἐκ πατέρων⁴
 λαμπρῶν,⁴ ἀλλὰ τοὺς αὐτοὺς τι γενναῖον ἐργασα-
 μένους, τοὺς δὲ στρατηγούς διὰ τοὺς προγόνους
 αἰρεῖσθαι, κἂν ὦσιν ἄχρηστοι,⁵ μὴ διὰ τὴν σφῶν
 23 αὐτῶν ἀρετὴν, κἂν μὴ γένει λαμπρύνωνται; προσ-
 όντων μὲν δὴ τούτων ἐκείνοις εὐτυχῆς ὁ στρατηγός,
 ἀπόντων δ' ἐκείνων, κἂν παρῆ ταῦτα, ἄ-
 24 πρακτος. ἐλπίσαι δ' ἂν τις τάχα καὶ ἀμείνους
 ἔσεσθαι στρατηγούς τοὺς οὐκ ἔχοντας ἐνσεμνύ-
 νεσθαι προγόνους· οἱ μὲν γὰρ ἐπὶ πατράσι κυ-
 δαινόμενοι, κἂν ἐλλίπωσιν,⁶ οἰόμενοι τὴν ἐκ τῶν
 πρόσθεν εὐκλειάν σφισι φυλάττεσθαι πολλὰ καὶ
 ῥαθυμότερον διοικοῦσιν, οἷς δ' οὐδεμία προὔπ-
 ἀρχει δόξα προγόνων, οὗτοι τὴν ἐκ πατέρων³
 ἐλάττωσιν ἐθέλοντες⁷ ἀναπληρῶσαι τῇ σφετέρᾳ
 προθυμίᾳ φιλοκινδυνότερον ἐπὶ τὰς πράξεις ἀμιλ-
 25 λῶνται· καὶ καθάπερ οἱ πενέστεροι τῶν εὐπο-
 ρωτέρων ταλαιπωρότερον ἐπὶ τὴν τοῦ βίου κτῆσιν
 ὤρμηται τὸ ἐλλεῖπον ἀναπληρῶσαι τῆς τύχης
 σπεύδοντες, οὕτως, οἷς μὴ πάρεστι κληρονομου-

¹ ἂν περιόπτου F, corr. C: ἀνόητον vGH.

² Köchly: καὶ πρόσθεν (τὰ πρόσθεν CRDFNA m²): τήρησον
 θάπτον ἐκείνον ὅτε πῶς F: καὶ πρόσθεν. ἐκείνο δὲ πῶς vGH.

³ FGH: προγόνων v.

⁴ λαμπροὺς vGH.

just as we test the pedigrees of animals in the light of the things they actually do, so we should view the pedigrees of men also. For it is dangerous to consider what fine thing a general's ancestors have done, rather than what the generals now chosen will do, as if those long dead could still protect us, and as if they would maintain us in our former possessions. As a matter of fact, is it not sheer stupidity to honour soldiers for valour, not those of famous families but those who have done some noble deed themselves, but on the other hand to select generals, even if they are incompetent, on account of their ancestors and not on account of their own worth, even if their families are unknown? Of course, if a general has birth in addition to these other qualities, he is fortunate, but even if he has a famous name without the other qualities, he is useless. It might perhaps be expected that those men who cannot take pride in their ancestors would become even better generals; for men who glory in their forefathers, even if they are themselves failures, believing that the fame of their family is theirs forever are often too careless as administrators, whereas those who have no ancestral renown to begin with, desiring to make up for the obscurity of their lineage by their own zeal, are more eager to take part in dangerous enterprises. Just as the poor man, eager to supply what fortune omitted, will endure more than the rich man in getting a start to make his fortune, so the man who can avail himself of no inheritance

⁵ FC: χρηστοι Ω (including P).

⁶ ελλείπωσι vGH.

⁷ FCD: ελθόντες vGH.

ONASANDER

μένη πατέρων¹ ἀποχρήσασθαι δόξῃ, τὴν ἀρετὴν
ιδιόκτητον οἰκειώσασθαι προαιροῦνται.

II. [Περὶ ἀγαθοῦ στρατηγοῦ διαίρεσις]²

Ζηλούσθω³ μὲν δὴ ἡμῖν ὁ στρατηγὸς ὁ ἀγαθὸς⁴
εὐγενὴς καὶ⁵ πλούσιος, μὴ ἀποδοκιμαζέσθω δὲ
πένης μετὰ ἀρετῆς, εἰ καὶ μὴ⁶ ἀπὸ λαμπρῶν.
2 αἰρεθεὶς δ' ὁ στρατηγὸς ἔστω χρηστός, εὐπρο-
ήγυρος, ἔτοιμος, ἀτάραχος, μὴ οὕτως ἐπικεικὴς
ὥστε καταφρονεῖσθαι, μήτε φοβερὸς ὥστε μι-
σεῖσθαι, ἵνα μήτε ταῖς χάρισιν ἐκλύσῃ τὸ στρα-
3 τόπεδον μήτε τοῖς φόβοις ἀλλοτριώσῃ. λοχαγοὺς
δὲ καθιστάτω καὶ ταξιάρχους⁷ καὶ χιλιάρχους,⁸
καὶ εἴ τινων ἄλλων ἡγεμόνων προσδεῖν αὐτῷ δόξαι,⁹
τοὺς εὐνουστάτους τῇ πατρίδι, πιστοτάτους,¹⁰ εὐ-
ρωστοτάτους, ἔνθεν δ'¹¹ οὐδὲν ἂν κωλύοι¹² καὶ
4 τοὺς εὐπορωτάτους καὶ τοὺς εὐγενεστάτους· οὐ
γάρ, ὡς ὀλίγους αἰρουμένους¹³ στρατηγοὺς ἐκ
τρόπου δοκιμάσαι ῥᾶον, κἂν ἀπῆ ὁ τῶν χρημάτων¹⁴
μετ' εὐγενείας ὄγκος, οὕτως που καὶ λοχαγῶν καὶ
5 ταξιαρχῶν πλήθος. ὅθεν τὸ μὲν εὐγενές ἐπὶ τού-
των προκριτέον εἰς πρόχειρον ἐν ὅξει καιρῷ δοκι-
μασίαν,¹⁵ τὸ δὲ ἐν εὐπορίᾳ,¹⁶ ἐπειδὴ¹⁷ ἀναλώσαι
τε καὶ δοῦναι στρατιώταις οἱ ἐκ περιουσίας δυ-
νατοί, χορηγία δ' ἀπὸ τῶν ἡγουμένων ὀλίγη πρὸς

¹ FGHR: προγόνων v.

² In text GH (v?): om. F: C puts it after § 1 where it really belongs, since § 1 is properly the conclusion of the preceding chapter.

³ Ζητεῖσθω Koraes.

⁴ F: ἡμῖν στρατηγὸς ὁ ἀγαθὸς GH: στρατηγὸς ἀγαθὸς v: δὴ στρατηγὸς ἡμῖν ἀγαθὸς von Rohden.

⁵ Om. Ω.

⁶ εἰ μὴ καὶ vGH.

⁷ ταξιάρχας GH.

⁸ καὶ χιλιάρχους FC: om. vGH.

⁹ δόξει vGH.

THE GENERAL, I. 25 - II. 5

of ancestral glory determines to make his own the virtue which he himself acquires.

II. [*The Characteristics of a good General*]

So that general is to be praised who is good, wealthy, and well-born, but the excellent general who is not wealthy is not to be rejected, even if of humble family. The general when chosen must be trustworthy, affable, prompt, calm, not so lenient as to be despised, nor so severe as to be hated, so that he may neither through favours loosen the bonds of discipline, nor estrange the army through fear. He must appoint as lieutenants, captains, and colonels, as well as other officers, if it seems necessary, men who are most loyal to their country, most faithful, and most vigorous—though there is nothing to prevent their being of the greatest wealth and nobility. As the number of generals to be chosen is small, they may be easily judged from their characters, even if the dignity of wealth and birth is lacking; but this is not the case with the multitude of subordinate officers. And so by off-hand judgement required at a crucial moment the nobility have to be preferred, but when there is no urgency, the wealthy, since those who have abundant means can spend money on the soldiery and make them gifts; for a slight expenditure by the officers

¹⁰ καὶ πιστοτάτους vGH: πιστοτάτους τε καὶ C.

¹¹ Om. vGH. ¹² κωλύη v: κωλύη GH. ¹³ αἰρουμένοις F.

¹⁴ Köchly: ἀπὴ χρημάτων F: ἀπὸ χρημάτων GH: ἀπὸ (ομι. τῶν?) v: ἀπὴ τῶν χ. μετ' οὐ ἀπὴ τῶν χ. ὁ μετ' von Rohden.

¹⁵ καιρὸν δοκιμασίας GH: καιρῶ δοκιμασίας FNRA m².
After δοκιμασίαν an interval in F.

¹⁶ ἀπορία Rigaltius.

¹⁷ ἐπειδὴ γ' von Rohden.

ONASANDER

τοὺς ὑποταττομένους¹ εὐνούστερα παρασκευάζει τὰ πλήθη· καὶ ἀσφαλεῖς αἱ² μειζόνων πίστεις³ πραγμάτων τοῖς περὶ πλειόνων κινδυνεύουσιν, εἰ μὴ⁴ πάνυ τὸ πιστόν, ὡς ἂν εἰ στρατηγοῖ τις,⁴ ἐκ τοῦ τρόπου παρέχοιτο.

III. [Περὶ τοῦ ἔχειν τὸν στρατηγὸν βουλευτάς⁵]

Αἰρείσθω δὲ ἤτοι⁶ συνέδρους, οἳ⁷ μεθέξουσιν αὐτῷ πάσης βουλῆς καὶ κοινωνήσουσι γνώμης αὐτοῦ⁸ οἱ⁹ τούτου εἵνεκα¹⁰ ἀκολουθήσοντες,¹¹ ἢ ἐξ αὐτῶν τῶν ἡγεμόνων τοὺς ἐντιμοτάτους μεταπεμπόμενος συνεδρευέτω, ὡς,¹² ἂν γέ τις ἂν ἐννοήσῃ μὲν μόνος, ὡς τὰ αὐτοῦ, οὐ βεβαίως¹² οἰκειοῦται.

² γνώμη γὰρ ἢ μὲν ἀνεπικούρητος μονουμένη παπταίνει¹³ περὶ τὴν ἰδίαν εὔρεσιν,¹⁴ ἢ δὲ ὑπὸ τῶν πέλας ἐπιμαρτυρηθεῖσα πιστοῦται τὸ μὴ σφαλερόν.

³ οὐ μὴν ἀλλὰ μῆθ' οὕτως ἄστατος ἔστω τὴν διάνοιαν, ὡς αὐτὸν αὐτῷ¹⁵ πάμπαν ἀπιστεῖν, μῆθ' οὕτως ἀθάδης, ὡς μὴ τι καὶ παρ' ἄλλω τοῦ παρ' αὐτῷ¹⁶ κρεῖττον οἶεσθαι νοηθῆναι· ἀνάγκη γὰρ τὸν τοιοῦτον ἢ πᾶσι¹⁷ προσέχοντα καὶ μηδὲν αὐτῷ¹⁸ πολλὰ καὶ ἀσύμφορα πράττειν, ἢ μηδ' ὀλίγ' ἄλλων¹⁹ ἀκούοντα, πάντα δ' αὐτοῦ,²⁰ πολλὰ καὶ δεινὰ²¹ διαμαρτάνειν.²²

¹ ὑποτεταγμένους vGH.

² F C: ἀσφάλεια vGH.

³ πίστις GH.

⁴ F: εἰ πάνυ στρατηγὸς ἐκ vGH.

⁵ Om. F which has not even an interval between II and III.

⁶ F: δὲ αὐτὸν καὶ vGH.

⁷ οἳ καὶ vGH.

⁸ αὐτῷ Koraes.

⁹ ἢ vGH. ¹⁰ F': ἕνεκα Ω Kóchly.

¹¹ Del οἱ . . . ἀκολουθήτοντες von Rohden.

¹² Kóchly: ὡς ἂν γέ τις ἐννοήσῃ μὲν μόνος τὰ αὐτοῦ βεβαίως F':

THE GENERAL, II. 5 – III. 3

for the benefit of their men makes the rank and file better disposed; and the pledges of greater rewards can be depended upon when made by those who have more at stake—that is, if the confidence a general ought to inspire is not altogether furnished by his character.

III. [*The General's advisory Council*]

The general should either choose a staff to participate in all his councils and share in his decisions, men who will accompany the army especially for this purpose, or summon as members of his council a selected group of the most respected commanders, since it is not safe that the opinions of one single man, on his sole judgement, should be adopted. For the isolated decision of one man, unsupported by others, can see no farther than his own ingenuity, but that which has the additional testimony of councillors guarantees against mistake. However, the general must neither be so undecided that he entirely distrusts himself, nor so obstinate as not to think that anyone can have a better idea than his own; for such a man, either because he listens to every one else and never to himself, is sure to meet with frequent misfortune, or else, through never listening to others but always to himself, is bound to make many costly mistakes.

ὥστε (ὥστε τε PD) δεῖ ἃ ἐννοῆσαι μὲν μελετᾶν μόνος δὲ οὐ τὰ αὐτοῦ βεβαίως PDGH: von Rohden objects to οὐ.

¹³ πταλεῖ vGH.

¹⁴ ἀλρεσιν vGH.

¹⁵ Köchly: αὐτὸν αὐτῷ F: αὐτὸς αὐτῷ vGH (αὐτῷ GH).

¹⁶ Köchly: αὐτῷ F: αὐτὸν vGH.

¹⁷ πάσῃ F.

¹⁸ Köchly: αὐτῷ FGH: αὐτῷ v.

¹⁹ Köchly: ὀλίγων Ω.

²⁰ Koræes: δ' αὐτοῦ FC: δι' αὐτοῦ PGH.

²¹ Köchly: om. Ω.

²² ἁμαρτανειν \ G (ἀμ-) H.

ONASANDER

IV. [Περὶ τοῦ ὅτι δεῖ τὴν ἀρχὴν τοῦ πολέμου ἐξ εὐλόγου αἰτίας ἐπάγειν]¹

Τὰς δ' ἀρχὰς τοῦ πολέμου μάλιστα φημι χρῆ-
ναι φρονίμως συνίστασθαι καὶ μετὰ τοῦ δικαίου
πᾶσι φανερόν γίνεσθαι πολεμοῦντα· τότε γὰρ καὶ
θεοὶ συναγωνιστὰι τοῖς στρατεύουσιν εὐμενεῖς
καθίστανται,² καὶ ἄνθρωποι προθυμότερον ἀντι-
2 τάττονται τοῖς δεινοῖς.³ εἰδότες γάρ, ὡς οὐκ
ἄρχουσιν ἀλλ' ἀμύνονται,⁴ τὰς ψυχὰς ἀσνει-
δήτους κακῶν ἔχοντες ἐντελῆ⁵ τὴν ἀνδρείαν⁶ εἰσ-
φέρονται, ὡς, ὅσοι γε νομίζουσι νεμεσήσειν⁷ τὸ
θεῖον ἐπὶ τῷ παρὰ τὸ δίκαιον ἐκφέρειν πόλεμον,
αὐτῇ τῇ οἰήσει, κἂν μὴ τι δεινὸν ἀπὸ τῶν πολεμίων
3 ἀπαντήσειν μέλλη,⁸ προκατορρωδοῦσιν. διὰ τοῦτο
δεῖ τὸν στρατηγόν, ὧν τε βούλεται τυχεῖν καὶ ὧν
μὴ παραχωρῆσαι, λόγῳ καὶ πρεσβείαις προ-
καλεῖσθαι⁹ πρῶτον, ἢ ἐν τῷ μὴ συγκαταβαίνειν
τοῖς ἀξιουμένοις τοὺς ἐναντίους¹⁰ ἀνάγκῃ δοκῆ,¹¹
καὶ μὴ προαιρέσει τὴν δύναμιν ἐξάγειν πολεμή-
σουσαν,¹² ἐπιμαρτυράμενος¹³ τὸ θεῖον, ὡς οὔτε
καταφρονῶν ὧν συμβαίνει τοὺς πολεμοῦντας
πάσχειν, ἀνεμεσήτως ἔπεισιν, οὔτε ἐκ παντὸς
4 λεμίου.¹⁴ εἰδέναι δὲ χρή, καθότι οὐ μόνον οἰκίας

¹ Title om. F.

² θεὸς συναγωνιστῆς τοῖς στρατεύμασιν εὐμενῆς καθίσταται vGH
(a Christian interpolation).

³ ἐναντίοις Kōchly.

⁴ ἀμύνονται PGH.

⁵ ἐντελεῖ corr. to ἐντελῆ F m²(?): ἐντελεῖ AB.

⁶ ἀνδρίαν v.

⁷ μὴ νεμεσήσειν vGH.

⁸ Koraes: μέλλει Ω.

⁹ F (also conj. by Schwebel): προσκαλεῖσθαι vGH.

¹⁰ FCGH: τοὺς ἀξίους τοῖς ἐναντίοις ENPRV.

THE GENERAL, iv. 1 - 4

IV. [*The Necessity of a reasonable Cause for War*]

The causes of war, I believe, should be marshalled with the greatest care; it should be evident to all that one fights on the side of justice. For then the gods also, kindly disposed, become comrades in arms to the soldiers, and men are more eager to take their stand against the foe.¹ For with the knowledge that they are not fighting an aggressive but a defensive war, with consciences free from evil designs, they contribute a courage that is complete; while those who believe an unjust war is displeasing to heaven, because of this very opinion enter the war with fear, even if they are not about to face danger at the hands of the enemy. On this account the general must first announce, by speeches and through embassies, what he wishes to obtain and what he is not willing to concede, in order that it may appear that, because the enemy will not agree to his reasonable demands, it is of necessity, not by his own preference, that he is taking the field. He should call heaven to witness that he is entering upon war without offence, since he has not failed to consider the dangers that fall to the lot of combatants, and is not deliberately seeking, in every possible manner, to ruin the enemy. He should know that not only is a firm foundation

¹ Something of a commonplace even in antiquity; for typical expressions see Thucydides ii. 74; Xenophon, *Cyropædia*, i. 5. 13-14; Dionysius of Halicarnassus ii. 72. 30.

¹¹ δοκεῖ ν (incl. P) GH.

¹² F (also conj. by Koraes): πολυμοῦσαν νGH.

¹³ ἐπιμαρτυρόμενος νGH.

¹⁴ FC: προσηρημένους τοῖς πολεμίοις GH: προσηρημένοι τοῖς πολεμίοις Pν.

ONASANDER

καὶ τείχους ἐδραιότερον ὑφίστασθαι δεῖ τὸν θε-
 μέλιον, ὡς ἀσθενούς γε ὄντος¹ συγκαταρρησο-
 μένων² καὶ τῶν ἐποικοδομουμένων, ἀλλὰ καὶ πο-
 λέμου τὰς³ ἀρχὰς δεῖ κατασκευασάμενον ἰσχυ-
 ρῶς καὶ κρηπίδα περιθέμενον ἀσφαλείας,⁴ οὐ-
 τως ἐξάγειν τὰς δυνάμεις· ὧν γὰρ ἀσθενῆ τὰ πράγ-
 ματὰ ἐστίν, ἐπειδὴν οὗτοι μέγα βάρος ἀναλάβωσιν
 5 πολέμου, ταχὺ θλίβονται καὶ ὑστεροῦσιν. ὅθεν,
 ὡσπερ ἀγαθὸν κυβερνήτην ἐκ λιμένος ἐξαρτυσά-
 μενον τὸ⁵ σκάφος καὶ τὰ παρ' αὐτῶ⁶ ἅπαντα
 ποιήσαντα, τότε ἐπιτρέπει⁷ χρῆ τῇ τύχῃ, ὡς
 αἰσχιστόν γε⁸ καὶ σφαλερόν ὑποδείξαντα πολέμου
 κίνησιν, ὥστε καὶ διὰ θαλάττης ἤδη καὶ διὰ γῆς
 ἄγειν τὸ στράτευμα, κἄπειτα πρύμναν κρούεσθαι.⁹
 6 τῆς μὲν γὰρ ἀνοίας καὶ προπετείας ἕκαστος κατ-
 εγέλασεν, τῆς δ' ἀσθενείας κατεφρόνησεν,¹⁰ οἱ δ'
 ἐχθροί, οἷτινές ποτ' ἂν ὦσιν, κἂν μὴ πάθωσιν, ὡς
 οὐχὶ μὴ βουλευθέντας¹¹ ἀλλ' οὐ δυνηθέντας δια-
 θεῖναι τι¹² δικαίως ἐμίσησαν.

V. [Περὶ τοῦ ἐξιλεοῦσθαι πρῶτον ὑπὲρ τῶν ἀμαρ-
 τιῶν τὸ θεῖον¹³ ὁ στρατηγὸς ἐξάγων εἰς πόλεμον]¹⁴

Ἐξαγέτω δὲ τὰς δυνάμεις ὁ στρατηγὸς καθαρὰς
 ἢ οἷς νόμοι¹⁵ ἱεροὶ ἢ οἷς μάντις ὑφηγοῦνται κα-

¹ FENRGH: *δυνας* PA m² and "quidam libri" (Schwebel).

² A m² GH (v?): *συγκαταρτισομένων* F.

³ PGH: *τοῦ πολέμου τὰς v: πολεμοῦντας* F.

⁴ Köchly suggests *ἀσφαλῶς*.

⁵ Om. vGH.

⁶ Köchly: *αὐτῶ* ENR: *αὐτῶν* vGH: *αὐτὸν* F: *παρ' αὐτῶ*
 περι αὐτὸ von Rohden.

⁷ F (and Leo, *Tactica*, xx. 170 ἐπιτρέπε): *ἐπιτρέχειν* vGH.

⁸ τε vGH.

THE GENERAL, IV. 4 - V. 1

necessary for houses and walls—for if this is weak the superstructures will also collapse—, but that in war also it is only after one has prepared a firm beginning, and has laid a safe foundation, that he should take the field. For those whose cause is weak, when they take up the heavy burden of war, are quickly crushed by it and fail. Just as a careful ship-captain, after he has given his ship a thorough overhauling and outfitting while in harbour, and has done everything within his own power, must then commit his craft to Fortune, so it is most disgraceful and dangerous for a general, after he has given intimations of a beginning of war, implying an immediate advance of his forces by both land and sea, then to back out. For while every one laughs at folly and rashness, we despise weakness, and the enemy—whoever they may be—even if they experience no harm, have good reason to hate the would-be invaders, as men who have not lacked the will, but lacked the ability to put a matter through.

V. [*Propitiation of the divine Power by the General before leading the Army into Battle*]

Before the general leads out his army he must see that it is purified, by such rites as either the laws or

⁹ Ω: κροΐσασθαι Köchly, after the emendation in A.

¹⁰ κατεφρόνησαν F, followed by an interval, as though a chapter ended here, with the first letter of μη rubricated.

¹¹ βουλευθέντες^α G: βουλευθέντα H. ¹² Added by Köchly.

¹³ τὸ θεῖον GH: om. v.

¹⁴ Om. F (whole title): in text GH.

¹⁵ ὡς νόμοι PGH: ὡς οἱ νόμοι ENR.

ONASANDER

θαρσίοις, πᾶσαν, εἴ τις ἢ δημοσίᾳ¹ κηλὶς ἢ ἰδίου μολύσματος² ἐκάστω σύνεστιν, ἀποδιοπομπούμενος.

VI. [Περὶ τοῦ ἄγειν ἐν τάξει τὸ στρατόπεδον]³

Ἀγέτω δὲ τὸ στράτευμα πᾶν ἐν τάξει, κἂν μήπω μέλλῃ συμβάλλειν, ἀλλὰ διὰ μακρᾶς ὁδοῦ περαιοῦσθαι καὶ πολλῶν ἡμερῶν ἀνύειν πορείαν, καὶ ἐν τῇ φιλίᾳ καὶ ἐν τῇ πολεμίᾳ· διὰ μὲν τῆς φιλίας,⁴ ἵνα ἐθίζηται⁵ τὰ στρατεύματα μένειν ἐν τάξει καὶ συμφυλάττειν τοὺς ἰδίους λόχους καὶ ἔπεσθαι τοῖς ἡγεμόσιν, διὰ δὲ τῆς πολεμίας πρὸς τὰς ἐξαίφνης ἐπιβουλὰς⁶ γιγνομένας, ἵνα μὴ ἐν ὀξείῳ καιρῷ⁷ θορυβούμενοι καὶ⁸ ἐπαναθέοντες καὶ ἄλλοι πρὸς ἄλλους φερόμενοι⁸ μηδὲν μὲν ἀνύσωσι φθασθέντες,⁹ πολλὰ δὲ καὶ¹⁰ δεινὰ πάθωσιν, ἀλλ' ἅμα καὶ εἰς πορείαν¹¹ ὧσιν ἐπιδέξιοι καὶ εἰς μάχην εὐτρεπεῖς,¹² ἔχοντες καὶ τὸ σύνθημα¹³ καὶ ἄλ-
² λήλους ἐν τάξει βλέποντες.¹⁴ συστέλλειν δὲ πειράσθω τὴν πορείαν¹⁵ τοῦ στρατεύματος, ὡς ἐνὶ μάλιστα, πρὸς ὀλίγον, καὶ διὰ τοιούτων, ἂν δυνατὸν ἦ, χωρίων ἀγέτω τὰς τάξεις, δι' ὧν οὐκ ἂν ἐκθλιβόμεναι στεναὶ καὶ οὐκ ἔχουσαι πλάτος
³ ἐκ πλευρᾶς ἐπὶ μήκιστον ἐκταθεῖεν· καὶ γὰρ εὐπαθέστεραι¹⁶ γίνονται¹⁷ πρὸς τὰς αἰφνιδίους τῶν

¹ δημοσία Ω.

² Köchly: ἢ (or ἢ F) διαμολύσματος FPGH: διαμόλισμα R.

³ Om. F (whole title): in text GH.

⁴ FC (καὶ πολεμία): καὶ ἐν τῇ π. . . . φιλίας om. vPGH.

⁵ FCENR: ἐθίζεται PGH: ἐθίζεσθαι v.

⁶ ἐπιβουλὰς Schwebel. ⁷ καιροῦ vGH.

⁸ Om. καὶ . . . φερόμενοι CH (added in margin by m¹ [?]).

⁹ φθάσαντες vGH.

THE GENERAL, v. 1 – VI. 3

soothsayers direct, and must avert whatever taint there is in the state or in any citizen, by expiatory sacrifices.

VI. [*On Maintaining Military Formation*]

The general must lead his entire army in military formation, even if he is not on the point of battle, but is completing a long journey and a march of many days through either a friendly or a hostile country; through a friendly country, that the soldiers may become accustomed to remaining in rank, to keeping to their own companies, and to following their own leaders; through a hostile country, to guard against sudden attacks from ambush, that the soldiers may not be thrown into disorder at a critical moment, running against and stumbling over one another, and so accomplishing nothing but rather suffering severe loss; they must proceed, prepared at the same time for marching and for battle, remembering their watchword and keeping their eyes on their comrades in the ranks. The general must attempt to make the marching order of his army as compact as possible, and should lead his troops through such a country—so far as he is able—that the ranks may not be so cramped, being narrow and having no width, that they cannot be deployed to a considerable distance laterally. For lines so disposed suffer more

¹⁰ Om. H (end of line).

¹¹ ἐς πορείαν v: εὐπορείαν GH.

¹² FC: εὐπρεπεῖς vGH.

¹³ In GH in marg. περι τοῦ ἔχειν σύνθημα τὸν λαόν (which Rigaltius found in three mss. and which appears also in A m²), absurd as a chapter heading.

¹⁴ βλέποντας F.

¹⁵ FC: στρατεῖαν vPGH.

¹⁶ εὐπαθέστερον R: εὐπαθέστεροι v.

¹⁷ γίγνονται GH.

ONASANDER

πολεμίων ἐπιφανείας αἱ τοιαῦται καὶ ἤκιστα δρα-
στήριοι· ἄν τε γὰρ σφισι κατὰ μέτωπον ὑπαντή-
σωσιν οἱ πολέμιοι πλατύτεροι τεταγμένοι, ῥαδίως
αὐτοὺς τρέπονται, καθάπερ οἱ τοὺς ἐπὶ κέρως
ὄντας ἐν ταῖς μάχαις κυκλούμενοι, ἄν τε κατὰ
μέσσην τὴν δύναμιν ἐκ πλευρᾶς ἐπιβάλωσι,¹ ταχὺ
διέσπασαν αὐτῶν τὴν πορείαν καὶ διέκοψαν — ἐπι-
στρεψάντων γὰρ αὐτῶν εἰς φάλαγγα πρὸς ἄμυναν
ἀσθενῆς ἢ μάχη γίνεται² καὶ οὐκ ἔχουσα βάθος—,
ἐάν³ τε τοῖς κατόπιν, ἢ⁴ κατὰ νότου μάχη δεινῆ⁵
καὶ προφανῆ τὸν ὄλεθρον ἔχουσα, κἂν ἐπιστρέψαι
δὲ τολμήσωσιν εἰς μέτωπον, ἢ αὐτῇ⁶ γίγνεται
μάχη τοῖς ἐν τῇ πρωτοπορεία τεταγμένοις· ταχὺ
⁴ γὰρ αὐτοὺς περιστήσονται. συμβαίνει δὲ καὶ τὰς
παραβοηθείας δυσχερεῖς καὶ ἀπράκτους γίνεσθαι.⁷
τῶν γὰρ ἀπὸ τῆς οὐραγίας τοῖς εἰς τὴν πρωτο-
πορείαν βουλομένων⁸ βοηθεῖν ἢ τῶν πρώτων τοῖς
κατόπιν βραδεῖα ἢ ἄφιξις καὶ οὐ κατὰ καιρὸν⁹
γίγνεται, διὰ πολλῶν, ὧν ὑστεροῦσιν ἢ προηγούν-
ται, σταδίων ἰεναὶ προθυμουμένων.

⁵ Ἡ δὲ συνεσταλμένη πορεία καὶ τετράγωνος ἢ μὴ
πάνυ¹⁰ παραμῆκης εἰς πάντα καιρὸν εὐμεταχείρι-
στός¹¹ ἐστὶ καὶ ἀσφαλής. ἔστι δ' ὅτε καὶ¹²
συνέβη τι τοιοῦτον¹³ ἐκ τῶν ἐκτεινομένων στρα-
τευμάτων, ὥστε¹⁴ Πανικὰ καὶ πτοίας¹⁵ ἀμφι-

¹ F: ἐπιβάλλωσιν vGH: ἐπιβάλωσιν Koraes (Köchly).

² F: γίγνεται GH Köchly. ³ ἐάν . . . ἔχουσα om. R.

⁴ ἢ F.

⁵ Köchly: δεινὴ μάχη κ. π. τ. ὁ. ἔ. βάθος· κἂν F: δεινὴ
μάχη ὁμοίως κ. π. ποιεῖται τ. ὁ. ὡσαύτως (ὡς αὐτως G, ὡς αὐτως
H) οὐκ ἔχουσα βάθος κἂν vGH. The order δεινὴ μάχη ἰς
defended by von Rohden. ⁶ αὐτῇ GH.

⁷ FGH: γίνεσθαι A m² Köchly.

⁸ βουλομένοις R.

under sudden attacks of the enemy and are least effective; should the enemy with a more extended front encounter the head of the column, they would easily put it to flight, just as in battle one army, by outflanking an enemy advancing in column formation, routs it. Should the enemy attack the centre of the column from the flank, they would quickly pierce it and cut through—for if the column wheels to meet the enemy, forming a phalanx, even this, lacking depth, will make but a weak resistance—; and, finally, should the enemy attack the rear of the column, the fighting with back to the foe would be dangerous and entail obvious destruction; and even if the soldiers in the column venture to face about and form a new front, the battle would amount to the same thing as the previous attack on the advance guard, *i.e.*, the enemy would quickly surround them. Furthermore, assistance is difficult to give and ineffectual, for when those in the rear desire to give aid to the head of the column, or those at the head to those in the rear, their arrival is delayed and ill-timed, however eager they may be to cover the many stades which separate them from the van or the rear respectively.

A marching formation that is compact and rectangular—not very much longer than its width—is safe and easy to manage for every emergency. A too greatly extended line of march may at times produce panic and apprehension due to uncertainty,

⁹ *καίρων* F. ¹⁰ *ἢ μὴ πάνυ* C (Capps): *ἢ περ ἢ πάνυ* vGH.

¹¹ *εὐμεταχείρισσ* F.

¹² Köchly: *τι* F: *οἰ.* vGH.

¹³ *τοσοῦτων* F.

¹⁴ *Om.* vGH.

¹⁵ Köchly: *om.* AB(F?): *πύας ποιάς* PGH: *πανικὰς πτοίας* R: *πανικὰ καὶ ποίαν τινὰς* FN.

ONASANDER

δόξους ἐμπίπτειν· ἐνίοτε γὰρ οἱ πρῶτοι καταβιβηκότες ἐξ ὄρειων εἰς ψιλὰ καὶ ἐπίπεδα χωρία¹ θεασάμενοι τοὺς κατόπιν ἐπικαταβαίνοντας ἔδοξαν εἶναι πολεμίων ἔφοδον, ὥστε μελλῆσαι² προσβάλλειν ὡς ἐχθροῖς, τινὰς δὲ καὶ εἰς χεῖρας ἐλθεῖν ἤδη.

8 Λαμβανέτω δὲ τὴν θεραπείαν καὶ τὰ ὑποζύγια καὶ τὴν ἀποσκευὴν ἅπασαν ἐν μέσῃ τῇ³ δυνάμει καὶ μὴ χωρὶς· ἂν δὲ μὴ τὰ κατόπιν ἀσφαλῆ πάνυ καὶ εἰρηναῖα νομίζῃ, καὶ τὴν οὐραγίαν ἐκ τῶν ἐρρωμενεστάτων καὶ ἀνδρειοτάτων συνιστάσθω, μηθὲν⁴ διαφέρειν αὐτὴν οἰόμενος πρὸς τὰ συμβαίνοντα τῆς πρωτοπορείας.

7 Προπεμπέτω δὲ ἱππεῖς τοὺς διερευνησομένους τὰς ὁδοὺς, καὶ μάλισθ', ὅτ' ἂν ὑλῶδεις καὶ περικεκλασμένας⁵ λόφοις ἐρημίας διεξίῃ· πολλάκις γὰρ ἐνέδραι πολεμίων ὑποκαθέζονται,⁶ καὶ λαθοῦσαι μὲν ἔστιν ὅτε τὰ ὅλα συνέτριψαν τῶν ἐναντίων πράγματα, μὴ λαθοῦσαι δὲ διὰ μικρᾶς φροντίδος φρόνησιν μεγάλην ἐμαρτύρησαν τῷ πολεμίῳ⁷

8 στρατηγῷ. τὴν μὲν γὰρ πεδιάδα καὶ ψιλὴν ἢ πάντων ὄψις ἱκανὴ προερευνήσασθαι⁸ καὶ γὰρ κονιορτὸς ἀναφερόμενος⁹ μεθ' ἡμέραν¹⁰ ἐμήνυσεν τὴν τῶν πολεμίων ἔφοδον, καὶ πυρὰ καιόμενα¹¹ νύκτωρ ἐπύρσευσεν¹² τὴν ἐγγὺς στρατοπεδείαν.

9 Ἀγέτω δὲ¹³ τὰς δυνάμεις, μὴ μέλλων μὲν ἐκ-

¹ χωρεῖα GH.

² μελλῆσαι vGH.

³ δυνάμει . . . οὐραγίαν Köchly (in part after Schwebel and Koraes): δυνάμει χωρὶς ἂν μὴ τὰ κατόπιν (κατόπιν F) ἀσφαλῆ πάλιν καὶ εἰρηναῖα νομίζῃ (νομίζῃ F) εἰ δὲ καὶ μὴ (μὴ καὶ F) τὴν οὐραγίαν Ω. ⁴ F: μηδὲν vGH.

⁵ περικεκλεισμένους v: περικεκλεισμένας GH.

⁶ FC: ὑπερκαθέζονται GH.

THE GENERAL, VI. 5 - 9

for sometimes the leaders, after descending from mountains into treeless and level regions, observing those in the rear still descending, have thought the enemy were attacking, so that they have been on the point of marching against their own men as enemies, and some have even come to blows.

The general must place his medical equipment, pack animals, and all his baggage in the centre of his army, not outside. Should he consider that his rear is not quite secure and undisturbed he should form his rear guard of the most vigorous and courageous soldiers, realizing that, in the light of experience, the rear is no less important than the front.

He must send ahead cavalry as scouts to search the roads, especially when advancing through a wooded country, or a wilderness broken up by ridges. For ambushes are frequently set by the enemy, and sometimes failure to detect them brings complete disaster to the opposing side, while their discovery, by a slight precaution, attests to the general of the enemy great prudence on the part of his adversary. For in a level and treeless country a general survey is sufficient for a preliminary investigation; for a cloud of dust announces the approach of the enemy by day, and burning fires light up a near-by encampment at night.

If the general is not about to form his line of

⁷ F (τῶ πολεμίῳ) πολεμίῳ vGH: τῶ τῶν πολεμίῳ Köchly.

⁸ FC: ψιλὴν πάντων ὄψις (ὄψις GH) καὶ μὴ προερευνησαντὸς τινος (-νήσαντος τινὸς GH) ἐδήλωσεν vGH.

⁹ FCD: ἀναφαινόμενος vGH.

¹⁰ FC: καθ' ἡμέραν vGH.

¹¹ FC: πυρακτούμενα vGH.

¹² F: ἐπύρσευσαν A m² GH (v?) Köchly.

¹² δὴ F.

ONASANDER

τάξειν εἰς μάχην, ἐὰν¹ ἐπείγηται τι φθάνειν συντομώτερον, εἰ ἀσφαλές εἶναι νομίζοι, καὶ νύκτωρ μέλλων δὲ κρίνειν ἅμα² τῷ³ σύνοπτον⁴ γενέσθαι τοῖς πολεμίοις εὐθύς⁵ τὰ πράγματα διὰ μάχης σχολῆ⁶ προῖτω καὶ μὴ πολλὴν ἀνυέτω· πολλάκις⁷ γὰρ πρό τῶν κινδύνων ὁ κόπος ἔδαπάνησεν τὴν ἀκμὴν⁸ τῶν σωμάτων.

- 10 Διοδεύων δὲ συμμαχίδα γῆν παραγγελλέτω τοῖς στρατεύμασιν ἀπέχεσθαι τῆς χώρας, καὶ μὴτ' ἄγειν τι μῆτε⁹ φθειρεῖν· ἀφειδές γὰρ πλῆθος ἅπαν ἐν ὄπλοις, ὅτ' ἂν ἔχη τὴν τοῦ δύνασθαι τι ποιεῖν ἐξουσίαν, καὶ ἢ ἐγγύς ὄψις ἀγαθῶν¹⁰ δελεάζει τοὺς ἀλογίστους ἐπὶ πλεονεξίαν· μικραὶ δὲ προφάσεις¹¹ ἢ ἀπηλλοτριώσαν συμμαχούς ἢ καὶ
- 11 παντελῶς¹² ἐξεπολέμωσαν. τὴν δὲ τῶν πολεμίων φθειρέτω καὶ καιέτω καὶ τεινέσθω¹³ ζημία γὰρ χρημάτων καὶ καρπῶν ἔνδεια μειοῖ πόλεμον, ὡς περιουσία¹⁴ τρέφει. προανατεινέσθω¹⁵ μέντοι πρῶτον, ὃ μέλλει ποιεῖν· πολλάκις γὰρ ἢ τοῦ μέλλοντος ἔσεσθαι δεινοῦ¹⁶ προσδοκία συνηνάγκασε, πρὶν ἢ παθεῖν, ὑποσχέσθαι τι τοὺς κινδυνεύοντας ὧν πρότερον οὐκ ἐβουλήθησαν¹⁷ ποιεῖν· ἐπειδὰν δ' ἅπαξ πάθωσιν, ὡς¹⁸ οὐδὲν ἔτι χεῖρον ὀψόμενοι τῶν λοιπῶν
- 12 καταφρονουσιν. εἰ δὲ πολὺν ἐν τῇ πολεμίᾳ μέλλει¹⁹

¹ F: μάχην μεθ' ἡμέραν (μεθ' ἡμέραν G) ἐὰν δὲ ἐπείγηται vGH.

² FC: εὐθύς ENAm²GH and the mss. of Rigaltius.

³ τὸ R. ⁴ σύνοπτος F corr. by AB.

⁵ FC: om. ENA m² GH and the mss. of Rigaltius.

⁶ σχολῆ GH and the mss. of Rigaltius.

⁷ With this word F indicates the beginning of a new section instead of after σωμάτων below. ⁸ ἀγμὴν GH.

⁹ μὴ θίγειν (θήγειν GH) τινὸς μηδὲ vGH.

¹⁰ τῶν ἀγαθῶν vGH.

THE GENERAL, vi. 9 - 12

battle, but is hurrying to be the first to arrive at a given point, he should lead his army by night marches also, provided he thinks it safe. But if he intends to decide the issue by battle as soon as he comes in sight of the enemy, he should at once advance slowly and not try to march too far; for in many cases, before the actual fighting, fatigue lessens men's physical fitness.

When passing through the country of an ally, the general must order his troops not to lay hands on the country, nor to pillage or destroy; for every army under arms is ruthless, when it has the opportunity of exercising power, and the close view of desirable objects entices the thoughtless to greediness; while small reasons alienate allies or make them quite hostile. But the country of the enemy he should ruin and burn and ravage, for loss of money and shortage of crops reduce warfare, as abundance nourishes it. But first he should let the enemy know what he intends to do; for often the expectation of impending terror has brought those who have been endangered, before they have suffered at all, to terms which they previously would not have wished to accept; but when they have once suffered a reverse, in the belief that nothing can be worse they are careless of future perils. If he intends to

¹¹ Kœchly: ἐπιπλέον ἔξει αἱ μακρὰι δὲ προφάσεις F: ἐπὶ πλεονεξία· μικρᾶ (μικρὰ GH) δὲ προφάσει vGH.

¹² ἢ (ἢ GH) παντελῶς vGH.

¹³ τεμνέτω vGH.

¹⁴ ὥσπερ ἡ οὐσία vGH.

¹⁵ ENP (margin) V (margin) G (margin) H (margin): πρὸς ἀναταυθίσθω F: προανατιθέσθω P: πρὸ ἀνατιθέσθω GH.

¹⁶ δεινοῦ ἔσσεσθαι vGH.

¹⁷ οὐκ ἔβουλήθησαν vGH.

¹⁸ FC: om. vGH.

¹⁹ ἂν . . . μέλλη (μέλλη GH) vGH.

ONASANDER

καταστρατοπεδεύειν χρόνον, τοσαῦτα καὶ τοιαῦτα φθειρέτω¹ τῆς χώρας ὧν αὐτὸς οὐχ ἔξει χρείαν, ἅττα δὲ ἀναγκαῖα² φυλαχθέντα τοῖς φιλίοις³ ἔσται, τούτων φειδέσθω.⁴

13 Τῶν δὲ δυνάμεων ἐκπεπληρωμένων μήτ' ἐπὶ τῆς ἰδιοκτητήτου⁵ μήτ' ἐπὶ τῆς ὑπηκόου μήτ' ἐπὶ τῆς συμμαχίδος καθεζόμενος ἐγχρορίζετω χώρας· τοὺς γὰρ ἰδίους ἀναλώσει καρπούς καὶ ζημιώσει πλεόν τοὺς φίλους ἢ τοὺς πολεμίους· μεταγέτω⁶ δ' ὡς θάπτον, ἐὰν ἀκίνδυνα ἦ τὰ οἴκοι,⁷ τὰς δυνάμεις· ἐκ γὰρ τῆς πολεμίας, εἰ μὲν εἶη δαμιλῆς καὶ εὐδαίμων, τροφήν ἔξει καὶ ἄφθονον,⁸ εἰ δὲ μή, τήν γε φιλίαν⁹ οὐ λυμανεῖται, πολλὰ δ' ὁμως¹⁰ καὶ ἀπὸ λυπρᾶς¹¹ τῆς ἀλλοτρίας ἔξει πλεονεκτήματα.

14 Φροντιζέτω δὲ περί τε ἀγορᾶς καὶ τῆς τῶν ἐμπόρων καὶ κατὰ γῆν καὶ κατὰ θάλατταν παραπομπῆς,¹² ἢν' ἀκινδύνου τῆς παρουσίας σφίσιν οὕσης¹³ ἀόκνως παρακομίζωσι¹⁴ τὸν εἰς τὰ ἐπιτήδεια φόρτον.

VII. [Περὶ τοῦ ὅταν¹⁵ διὰ στενῶν μέλλη τὸ στρατόπεδον ἄγειν]¹⁶

Ἐπειδὴν δὲ ἦτοι¹⁷ διὰ στενῶν μέλλη¹⁸ ποιέσθαι τήν¹⁹ πάροδον ἢ δι' ὀρεινῆς καὶ δυσβάτου

¹ φθειρέσθω v.

² ἀν καὶ δ F.

³ FC: φίλοις vGH.

⁴ Köchly: φειδέσθαι Ω.

⁵ FC: μήτ' ἐπὶ τῆς ἰδιοκτητήτου om. vGH: μήτ' ἐπὶ τῆς ὑπηκόου om. R.

⁶ With this word F indicates the beginning of a new section.

⁷ ἀκίνδυνον ἢ οἴκοι vPGH.

encamp for some time in the enemy's country, he must destroy only things of such a number and sort as he himself will not need ; whatever, if preserved, will be of advantage to his friends he should spare.

When the army is recruited to full strength, he must not settle down and stay either in his own country, or in that of a subject nation, or in that of an ally ; for he will consume his own crops, and do more damage to his friends than to his enemies. He should lead out his forces over the frontier as soon as possible, if matters are safe at home ; for from the enemy's country, if it is fertile and wealthy, he will have abundant provisions, but if it is not, he will at least not be injuring a friendly country, and he will still derive great gain even from the distress of the hostile country.

He should consider the matter of supplies, and the conveying of his merchants by land and sea, that they may arrive safely at his base of supplies, and that they may without hesitation transport their cargoes of provisions.

VII. [*On Leading an Army through narrow Defiles*]

Whenever the general intends to march through a narrow pass, or to lead his army over mountainous

⁸ τρυφήν . . . ἀφθονίαν vPGH.

⁹ τὴν τελέαν R.

¹⁰ δι' ὁμως RGH.

¹¹ λαμπρᾶς EFNPRH (λαμπρὰς G) Saguntinus and Camerarius.

¹² ἢ καταθάλατταν ἢ παραπομπης F.

¹³ οὕτως P : οὕτω EN.

¹⁴ παρακομίζουσι PGH.

¹⁵ ὅτε v.

¹⁶ Title om. by F : in marg. GH.

¹⁷ εἶτε \GH.

¹⁸ Köchly (v ?) : μέλλει FGH.

¹⁹ Added by Koraes.

ONASANDER

χώρας ἄγειν τὸν στρατόν,¹ ἀναγκαῖον προεκπέμποντά τι μέρος τῆς δυνάμεως προκαταλαμβάνεσθαι τὰς τε ὑπερβολὰς καὶ τὰς τῶν στενῶν παρόδους, μὴ φθάσαντες οἱ πολέμιοι καὶ καταστάντες ἐπὶ τῶν ἄκρων κωλύσωσι τὴν διεκβολὴν ² ποιεῖσθαι. τὸ δ' αὐτὸ πεφροντίσθω,² κἂν αὐτὸς³ δεδίη πολεμίων εἰσβολὴν· οὐ γὰρ δὴ⁴ δρᾶσαι μὲν χρήσιμον, φυλάξασθαι δὲ παθεῖν⁵ οὐκ ἀναγκαῖον, οὐδὲ φθάσαι μὲν αὐτοὺς εἰσβαλόντας⁶ εἰς τὴν πολεμίαν ἐπεῖγον, ἀποκλείσαι⁷ δὲ⁸ τοὺς ἐναντίους⁹ ἐπὶ σφᾶς ἰόντας οὐ προνοητέον.

VIII. [Περὶ τοῦ ποιεῖν χάρακα]¹⁰

Ἐν δὲ δὴ¹¹ τῇ τῶν ἐχθρῶν καταστρατοπεδεύων¹² χάρακα περιβαλέσθω¹³ καὶ τάφρον, κἂν¹⁴ ἐφ' ἡμέραν μέλλη τὴν παρεμβολὴν θήσειν· ἀμετανόητος γὰρ ἢ τοιαύτη καὶ ἀσφαλῆς¹⁵ στρατοπεδεῖα διὰ τὰς αἰφνιδίους καὶ ἀπρολήπτους¹⁶ ἐπιβολὰς.¹⁷ καθιστάτω δὲ φύλακας,¹⁸ κἂν μακρὰν εἶναι νομίζῃ τοὺς πολεμίους, ὡς ἐγγὺς ὄντων.¹⁹ ² ὅποι²⁰ δ' ἂν μέλλη²¹ πολυχρόνιον τίθεσθαι τὴν παρεμβολὴν οὐκ ἀντεπιόντων²² τῶν πολεμίων, ἐπὶ²³ τῷ φθείρειν τὴν χώραν ποιούμενος τὴν μονὴν²⁴ ἢ καὶ²⁵ καιροῖς ἐφεδρεύων²⁶ βελτίοισιν,²⁷

¹ FGH: στρατηγὸν P and "mss. quidam" Schwebel.

² πεφροντήσθω or -είσθω F¹ m¹ corr. by m².

³ FC and perhaps others: om. FGH.

⁴ FEN and perhaps others: δεῖ GH (v?).

⁵ μὴ παθεῖν vGH.

⁶ F (and conj. by Koraes): εἰσβάλλοντας vGH Köchly.

⁷ ἀποκλείσθαι Mm²: ἀποκεκλείσθαι EN. ⁸ μὲν F.

⁹ πολεμίους vGH.

¹⁰ Title om. F: in margin GH.

¹¹ Om. F.

¹² καταστρατοπεδεύωντων F.

and difficult country, he must send ahead part of his force to occupy the mountain-passes and the defiles, lest the enemy, coming first, make a stand on the summits and prevent the army from crossing. This he should observe even if fearing an attack by the enemy. For naturally it is not advantageous to take the initiative, without also recognizing the necessity of taking precautions against injury; nor is it necessary to outstrip the enemy in making an invasion into his country, without taking measures to prevent the enemy from marching against one's own country.

VIII. [*On Making a palisaded Camp*]

When encamping in the territory of the enemy, the general should fortify his camp with a palisade and a ditch, even if planning to remain in camp but one day; for on account of sudden and unexpected attacks, a fortified camp of this sort will be safe and never regretted. He should place guards, even if he believes the enemy to be at a great distance, just as if they were at hand. Whenever the enemy are not attacking, and he intends to encamp for some time, either for the purpose of ravaging the country, or to await a more advantageous time for

¹³ περιβαλλέσθω vGH.

¹⁴ F (and conj. by Koraes): αν vGH.

¹⁵ ἀσφαλείς H.

¹⁶ ἀπροσλήπτους C: ἀπροσδοκίτους vGH.

¹⁷ F (and conjecture of Schwabel): ἐπιβουλὰς Ω.

¹⁸ φυλακάς Koraes and Köchly.

¹⁹ FC: δυναίς vGH.

²⁰ σπου vGH.

²¹ R: μέλλοι Ω.

²² οὐ κατεπιόντων P: οὐκατεπιόντων G: οὐ | κατέπιόντων H: οὐ κατεπιόντων EN.

²³ ἢ ἐπὶ vGH.

²⁴ νομήν ENR.

²⁵ FPGH: οἰν. v.

²⁶ ἐφεδρευόντων F.

²⁷ βελτίσον H.

ἐκλεγέσθω χωρία μὴ ἐλώδη¹ μηδὲ νοτερά·² τὰ γὰρ τοιαῦτα ταῖς ἀναφοραῖς καὶ ταῖς ἀπὸ τῶν τόπων δυσωδίαις νόσους καὶ λοιμοὺς ἐμβάλλει στρατεύμασι,³ καὶ πολλῶν μὲν ἐκάκωσε τὰς εὐξίας, πολλοὺς δὲ ἀπώλεσεν, ὥστε μὴ μόνον ὀλίγον, ἀλλὰ καὶ ἀσθενὲς ἀπολείπεσθαι στρατεύμα.⁴

IX. [Περὶ τοῦ συνεχῶς ὑπαλλάσσειν τὰ ἀπληκτα]⁵

Χρήσιμον δὲ που καὶ σωτήριον στρατοπέδω μηδ' ἐπὶ τῆς αὐτῆς μένειν παρεμβολῆς, εἴαν μὴ χειμαδεύῃ καὶ τοῖς σκηνώμασι διὰ τὴν ὥραν τοῦ καιροῦ πεπολισμένη τυγχάνῃ· αἱ γὰρ⁶ τῶν ἀναγκαίων ἐκκρίσεις⁷ ἐπὶ τῶν αὐτῶν γιγνόμεναι⁸ χωρίων ἀτμοὺς διεφθορότας ἀναπέμπουσαι συμμεταβάλλουσι καὶ τὴν τοῦ περιέχοντος ἀέρος² χύσιν. ἐν δὲ ταῖς χειμασίαις⁹ γυμναζέτω τὰ στρατόπεδα καὶ πολεμικὰ καὶ σύντροφα¹⁰ ποιείσθω τοῖς δευνοῖς, μήτ' ἀργεῖν ἐῶν¹¹ μήτε ῥαθυμεῖν· ἢ μὲν γὰρ ἀργία τὰ σώματα μαλθακὰ καὶ ἀσθενῆ κατεσκεύασεν, ἢ δὲ ῥαθυμία τὰς ψυχὰς ἀνάνδρους καὶ δειλὰς ἐποίησεν· αἱ γὰρ ἠδοναὶ δελεάζουσαι τῷ καθ' ἡμέραν συνήθει τὰς ἐπιθυμίας διαφθεῖ-
³ρουσι καὶ τὸν εὐτολμότατον.¹² ὅθεν οὐ μακρὰν ἀπάγειν¹³ τοὺς ἄνδρας τῶν πόνων· ἐπειδὴν γὰρ μετὰ χρόνον ἀναγκάζονται¹⁴ πρὸς τὰ πολεμικὰ χωρεῖν, οὐθ'¹⁵ ἠδέως ἐξίσιν οὐτ' ἐπὶ πολὺ

¹ FEN: ἐλώδη PRGH.

² Kschly: μηδὲ (μὴ δὲ FGH) νοτερά· Ω.

³ τοῖς στρατεύμασιν vGH.

⁴ τὸ στρατεύμα vGH.

⁵ Title om. by F; in margin GH. ἀπληκτον is a Byzantine word unknown earlier; see Du Cange and Sophocles.

THE GENERAL, VIII. 2 - IX. 3

battle, he must choose a locality that is not marshy, nor damp; for such places by their rising vapours and rank smell bring disease and infection to the army, and both impair the health of many and kill many, so that the soldiers are left few in number and weakened in strength.

IX. [*On continually Changing Camp*]

The general will find it advantageous and healthful for his army not to remain long in the same camp, unless it is winter and the army happens to be in huts on account of the time of year; for the necessary bodily excrement, deposited in the same place, gives off rank vapours and taints all the surrounding air. In winter quarters he should exercise his army and train it to be skilled in war and accustomed to danger, permitting no idleness nor relaxation; for idleness makes the body soft and weak, while relaxation makes the soul cowardly and worthless; since pleasures, capturing the passions by the enticement of daily habit, corrupt even the most courageous man. For this reason the soldiers must never be without occupation. When after some time spent in idleness they are compelled to go against the enemy, they do not go willingly nor

⁶ Om. P.

⁷ FCEN: ἐγκρήσεις P: ἐκρήσεις GH: ἐπικρήσεις R.

⁸ γιγνόμενοι F.

⁹ B and Schwebel: χειμαδiais Ω: τοῖς χειμαδίοις Koracs.

¹⁰ σύστροφα vGH. ¹¹ ἐκόντα R: ἔχων corr. to ἔκων A m².

¹² εὐτολμώτατον P.

¹³ ἐπάγειν ENM (margin): ἐπείγειν PGH. Köchly suggests the addition of δεῖ.

¹⁴ ἀναγκάζονται GH.

¹⁵ οὐχ vGH.

ONASANDER

μένουσιν,¹ ἀλλ' ἐκδεδιτημένοι² ταχὺ μὲν ὄρρω-
δοῦσι, πρὶν ἢ καὶ πειρᾶσαι τὰ δεινά, ταχὺ δὲ
καὶ³ πειράσαντες ἀποχωροῦσιν, οὐτ' ἐλπίζειν
οὔτε φέρειν τοὺς κινδύνους δυνάμενοι.

X. α'. [Περὶ τοῦ δεῖν⁴ γυμνάζειν τὸν στρατὸν⁵
ἀδείας οὔσης⁶]

Διόπερ ἀγαθοῦ στρατηγοῦ καὶ τὰ χρήσιμα τότε
κατασκευάζειν, ὅτ' οὐκ ἐπείγουσιν αἱ τῶν ἐκ
παρατάξεως ἀγώνων ἀνάγκαι, καὶ τὰ ἄχρηστα διὰ
τὴν τῶν σωμάτων ἄσκησιν ἐπιτάττειν. ἰκανὴ
γάρ στρατοπέδοις ἄνεσις, κἂν⁷ σφόδρα ταλαίπωροι
ᾧσιν,⁸ ἢ⁹ μὴ διὰ τῶν δεινῶν εἰς τὸ ἀληθινὸν ἀγώ-
νισμα πείρα.⁹ γυμναζέτω δὲ⁸ τοιοῖσδέ τισι¹⁰
τρόποις.

2 Ἐκταπτέτω πρῶτον ἀναδοὺς τὰ ὄπλα πᾶσιν, ἢ⁹
ἐν μελέτῃ¹¹ σφίσιν ἢ τὸ μένειν ἐν τάξει, καὶ ταῖς
ὄψεσι καὶ τοῖς ὀνόμασι συνήθεις ἀλλήλοις γιγνώ-
μενοι,¹² τίς ὑπὸ τίνα καὶ ποῦ καὶ μετὰ πόσους,¹³
ὑπ' ὅξυ¹⁴ παράγγελμα πάντες ᾧσιν¹⁵ ἐν τάξει·
καὶ τὰς τε ἐκτάσεις καὶ συστολὰς καὶ ἐγκλίσεις
ἐπὶ λαιὰ καὶ δεξιὰ,¹⁶ καὶ λόχων μεταγωγὰς καὶ
διαστήματα καὶ πυκνώσεις, καὶ τὰς δι' ἀλλήλων
ἀντεξόδους καὶ εισόδους, καὶ τὰς κατὰ λόχους

¹ μενοῦσιν F.

² FEN (and M by conj.): ἐκδεδιτημένοι P: ἐκδεδιτη-
μένοι GH: ἐκδεδιττομένοι R. ³ Om. vGH.

⁴ δεῖ ENRGH.

⁵ στρατηγὸν ENR.

⁶ Title om. F: in margin GH.

⁷ κἂν μὴ Capps.

⁸ ταλαίπωρῶσιν von Rohden.

⁹ εἰ . . . πειρᾶ ENRA m².

¹⁰ FGH: τοίοις δέ τισι v.

¹¹ ἐκ μελέτης vGH.

do they long stand their ground, but because they have departed from their former habits, they quickly become dismayed, even before making trial of danger, and even if they do make trial, they quickly retreat, being incapable either of feeling hope or of sustaining the stress of battle.

X. (1) [*The Need for Drilling the Army in Time of Peace*]

On this account it is the duty of a good general to prepare what is useful for war, when the necessity of a pitched battle is not pressing. He should also assign unproductive tasks to keep the army in good condition. For it is sufficient relaxation for soldiers, even if they are very weary, to exercise in arms without the dangers involved in a real battle. The general should train his troops in some such manner as the following.

First arming the soldiers, he should draw them up in military formation that they may become practised in maintaining their formation; that they may become familiar with the faces and names of one another; that each soldier may learn by whom he stands and where and after how many. In this way, by one sharp command, the whole army will immediately form ranks. Then he should instruct the army in open and close order; in turning to the left and right; the interchange, taking distance, and closing up of files; the passing and re-passing of files through files; the division into files; the

¹² γιγνόμεναι καὶ GH: γιγνόμεναι· καὶ P: γίγνωνται a MS. of Scaliger.

¹³ πύσων C.

¹⁴ ὑπὸ τι R.

¹⁵ σῶσιν GH.

¹⁶ λαῖα καὶ δεξιὰ V.

ONASANDER

διαιρέσεις, καὶ τὰς¹ κατατάξεις καὶ τὴν² ἐπὶ φάλαγγα ἐκτείνουσαν² καὶ τὴν ἐπὶ βάθος ὑποστέλλουσαν,³ καὶ τὴν ἀμφιπρόσωπον μάχην, ὅτ' ἂν οἱ κατ' οὐρὰν ἐπιστρέψαντες πρὸς τοὺς κυκλουμένους μάχωνται,⁴ καὶ τὰς ἀνακλήσεις ἐκδιδασκέτω.

3 Καθάπερ γὰρ ἐπὶ τῶν μουσικῶν ὀργάνων οἱ μὲν⁵ ἀρχὴν ἔχοντες τοῦ μανθάνειν ἐπιτιθέντες τοὺς δακτύλους ἐπὶ τε τὰ τρήματα⁶ τῶν αὐλῶν καὶ διαστήματα τῶν χορδῶν πολλάκις ἄλλον ἔθεσαν ἐπ' ἄλλην⁷ καὶ οὐ κατὰ τὴν ἀρμονικὴν διάστασιν, εἶτα μόλις ἐπεκτείναντες⁸ βραδὺ μὲν αἴρουσι⁹ τοὺς δακτύλους, βραδὺ δὲ τιθέασιν, οἱ δ' ἐν μελέτῃ τῆς μουσικῆς ἀνεπιτηδεύτως ἤδη¹⁰ ἐρρυθμισμένη¹¹ τῇ χειρὶ δι' ὀξύτητος μεταφέρουσιν, ὅπη τε βούλονται παραθλίψαι τῆς ἀναπνοῆς καὶ ἀνοῖξαι καὶ παραψῆλαι¹² χορδῆς· τοῦτον δῆπου τὸν τρόπον οἱ μὲν ἀσυνήθεις καὶ ἀνάσκητοι τῆς τάξεως διὰ ταραχῶν πολλοῦ μόλις ἀλλήλων διαμαρτάνοντες ἐγκατατάσσονται¹³ πολὺν ἀναλίσκοντες χρόνον, οἱ δὲ συγκεκριτοημένοι διὰ τάχους, ὡς εἰπεῖν αὐτόματοι, φέρονται πρὸς τὴν τάξιν ἐναρμόνιον τινα καὶ καλὴν ἐκπληροῦντες¹⁴ ὄψιν.

4 Εἶτα διελὼν τὰ στρατεύματα πρὸς ἀλλήλους ἀσιδήρῳ μάχῃ συναγέτω νάρθηκας ἢ στύρακας ἀκοντίων ἀναδιδούς, εἰ δέ τινα καὶ βεβωλασμένα

¹ Om. vGH.

² Om. F.

³ After ὑποστέλλουσαν vGH add καὶ τὴν ἐπὶ μήκος ἐκτείνουσαν (μήκος GH), obviously a gloss on ἐπὶ φάλαγγα ἐκτείνουσαν which means the same thing.

⁴ μάχονται vGH.

⁵ μὲν γὰρ R.

⁶ τρήματα PGH.

⁷ RA m²: ἐπ' ἄλλη F: ἐπ' ἄλλη vGH (ἐπάλλη GH).

THE GENERAL, x. 2 - 4

arrangement and extension of files to form the phalanx; withdrawing of files for greater depth of the phalanx; battle formation facing in two directions, when the rear guard turns to fight an encircling enemy; and he should instruct them thoroughly in the calls for retreat.

For just as those who begin to learn to play a musical instrument, in placing their fingers on the stops of the pipe or on the strings of the lyre, often set one finger on one and then another on another, without observing the interval that produces harmony, and then, with great effort, extending their fingers, they lift them slowly and slowly place them again; whereas practised players, no longer giving any evidence of care, with disciplined hand swiftly change from one note to another, lightly checking or opening the flow of air at will or lightly plucking the strings; in just this manner men unpractised and inexperienced in military formations, with great confusion and failure to find one another, will only after loss of much time take their places; but those who are well trained in formations quickly—indeed automatically, so to speak—rush to their stations, presenting a harmonious, I may say, and beautiful sight.

Next after dividing the army into two parts he should lead them against each other in a sham battle, armed with staves or the shafts of javelins; if there should be any fields covered with clods, he

⁸ FC: ἐπεκτείνουσι vGH.

⁹ αἴρουσι F.

¹⁰ Deleted by von Rohden.

¹¹ FCE: βερυθμισμένη PGH: ἀρρυθμισμένη R.

¹² παραψίλαι PGH.

¹³ ἐγκατάσσονται corr. το ἐγκατατάσσονται G.

¹⁴ FC: ἀποπληροῦντες vGH.

ONASANDER

πεδία εἴη, βώλους¹ τε κελεύων² αἴροντας³ βάλλειν⁴ ὄντων δὲ καὶ ἰμάντων ταυρείων⁵ χρήσθων⁶ ἐπὶ τὴν μάχην· δείξας δ' αὐτοῖς καὶ λόφους ἢ βουνούς ἢ ὀρθίους τόπους⁷ κελευέτω σὺν δρόμῳ καταλαμβάνεσθαι· ποτὲ δὲ καὶ ἐπιστήσας ἐπὶ αὐτῶν τινὰς τῶν στρατιωτῶν καὶ ἀναδοὺς ἅ μικρῶ πρόσθεν ἔφη ὄπλα, τούτους ἐκβαλοῦντας⁸ ἑτέρους ἐκπεμπέτω· καὶ ἦτοι⁹ τοὺς μείναντας¹⁰ ἐπαινείτω καὶ μὴ ἐκπεσόντας ἢ τοὺς ἐκβαλόντας.¹¹

5 ἐκ γὰρ τῆς τοιαύτης ἀσκήσεως καὶ γυμνασίας ὑγαιίνει μὲν τὸ στράτευμα, πᾶν δ'¹² ὃ τι οὖν ἦδιον ἐσθίει καὶ πίνει,¹³ κἂν λιτὸν ἦ,¹⁴ πολυτελέστερον οὐθὲν¹⁵ ἐπιζητοῦν· ὁ γὰρ ἀπὸ τῶν πόνων λιμὸς καὶ τὸ δίψος ἰκανὸν ὄψον ἐστίν¹⁶ καὶ γλυκὺ κρᾶμα, καὶ¹⁷ στερρότερα τε τὰ σώματά σφισι¹⁸ γίγνεται καὶ ἄκμητα,¹⁹ καὶ συνεθίζεται τοῖς μέλλουσι δεινοῖς, ἰδρῶτι καὶ πνεύματι καὶ ἄσθηματι²⁰ καὶ θάλπειν ἀσκιάστοις καὶ κρυμοῖς²¹ ὑπαίθροις ἐγγυμαζόμενα.²²

6 Παραπλησίως δὲ γυμναζέτω καὶ τὸ ἵππικὸν ἀμίλλας ποιούμενος²³ καὶ διώγματα καὶ συμπλοκάς καὶ ἀκροβολισμοὺς ἐν τοῖς ἐπιπέδοις καὶ²⁴ περὶ αὐτὰς τὰς ρίζας τῶν λόφων, ἐφ' ὅσον δυνατόν ἐστι καὶ τῶν τραχέων ἐπιψαύειν· οὐ γὰρ οἶον

¹ καὶ βελόνας (space for nine letters) εἴη βώλους F: βεβολασμένα παιδία εἴη βώλους GH (παιδία PR and βόλους P).

² τὲ καὶ λεύων H.

³ αἴροντας F.

⁴ βαλεῖν vGH.

⁵ DFKN: καὶ ταυρείων F: ἐκ ταυρείων vGH. Köchly suggests ταυρείων καὶ τούτοις.

⁶ χρήσθω vGH.

⁷ Köchly after Saguntinus: ἢ ὀρθίους βουνούς τόπους F: ἢ ὀρθίους βουνούς ἢ τόπους vGH.

⁸ ἐκβάλλοντας K: ἐκβάλλοντας C: ἐκβάλλοντας vGH.

⁹ ἦ vGH.

¹⁰ μείνοντας PGH: μένοντας EN.

¹¹ ἐκβάλλοντας F.

¹² δι' GH.

¹³ ἐσθίη καὶ πίνει F.

THE GENERAL, x. 4 - 6

should command them to throw clods; if they have any leather straps, the soldiers should use them in the battle.¹ Pointing out to the soldiers ridges or hills or steep ascents, he should command them to charge and seize these places; and sometimes arming the soldiers with the weapons I have just mentioned, he should place some on the hill-tops and send the others to dislodge them. He should praise those who stand firm without retreating, and those who succeed in dislodging their opponents. For from such exercise and training the army is kept in good health, eating and drinking everything with heartier appetite, even if the fare is plain, desiring nothing more luxurious. For the hunger and thirst derived from toil are a sufficient relish and a sweet draught, and muscles become harder and untiring; and trained by sweating, puffing, and panting, and exposed to summer heat and the bitter cold under the open sky, the soldiers become accustomed to future hardships.

In the same way the general should train his cavalry, arranging practice battles, both pursuits and hand-to-hand struggles and skirmishes in the plain and around the base of the hills, as far as it is possible to go in the broken country;

¹ This passage is derived from Xenophon, *Cyropaedia*, ii. 3. 17-18. Compare the Introduction.

¹⁴ Κοραες: ἀν λιτὸν ἢ FGH: ἀντὶ λητὸν ἢ P: ἀντὶ λιτὸν ἢ EN: σι τε λιτὸν ἢ R: ἀν τε λιτὸν ἢ C: ἀντιληττὸν ἢ A π².

¹⁵ FGH: οὐδὲν v.

¹⁶ ποιεῖ vGH.

¹⁷ Added by Köchly.

¹⁸ σφίσι Ω.

¹⁹ ἀγμητὰ PGH: ἀκμητὰ DEN.

²⁰ σώματι καὶ πνεύματι v'FGH.

²¹ κρημνοῖς EN.

²² συγγυμναζόμενα vGH.

²³ ποιουμένοις F: ποιούμενον R.

²⁴ Om. vGH.

ONASANDER

τε βιάζεσθαι πρὸς ἀνάντη καὶ κατὰ πρανοῦς¹
ἱππάζεσθαι.²

β'. [Περὶ προνομῶν]³

7 Σωφρονεῖτω δὲ περὶ τὰς προνομὰς καὶ μὴ ἐφίετω
ταῖς δυνάμεσιν,⁴ ἐπειδὴν εἰς εὐδαίμονα πολε-
μίων εἰσβάλλῃ⁵ χώραν, ἀτάκτως φέρεσθαι πρὸς
τὰς ὠφελίας.⁶ αἱ γὰρ μέγισται συμφοραὶ κἂν
τοιιοῖσδε⁷ γίνονται.⁸ πολλάκις γὰρ ἀτάκτοις καὶ
σποράσι περὶ τὴν λείαν σεσοβημένοις⁹ ἐπιπε-
σόντες οἱ πολέμοιοι καὶ διὰ τὸ ἀσύντακτον τοῦ
πλήθους καὶ διὰ τὸ βαρεῖς εἶναι¹⁰ τοὺς ἀποχω-
ροῦντας ταῖς ὠφελείαις οὔτε τοῖς ὅπλοις χρῆσθαι
δυναμένους οὔτ'¹¹ ἀλλήλοις ἐπικουρῆσαι πολλοὺς
8 διέφθειραν. εἰ δέ τις δίχα τοῦ τὸν στρατηγὸν
κελεύσαι προνομεύοιεν,¹² οὔτοι κολαζέσθων.¹³ αὐτὸς
γε μὴν¹⁴ ὅτ' ἂν ἐπὶ τὴν λείαν ἐκπέμπῃ,¹⁵ τοῖς
ψιλοῖς καὶ ἀνόπλοις συνταπτέτω¹⁶ μαχίμους ἱππεῖς
καὶ πεζοὺς, οἳ¹⁷ περὶ μὲν τὴν λείαν οὐκ ἀσχο-
λήσονται,¹⁸ μένοντες δὲ ἐν τάξει παραφυλά-
ξουσι¹⁹ τοὺς προνομεύοντας, ἵν' ἤ σφισιν ἀσφαλῆς
ἢ ἀποχώρησις.²⁰

¹ πραμοῦς A m².

² ἱππάζεσθαι GH: ὑπτάζεσθαι A m².

³ Title om. FGH: τῶν προνομῶν A.

⁴ F puts the break here.

⁵ εἰσβάλλῃ GHK (εἰσβάλλῃ GH).

⁶ ὠφελείας GH Kōschly (v?).

⁷ τοῖς τοιοῖσδε vGH Kōschly: om. C.

⁸ γίνωνται F.

⁹ σεσοβημαίνους GH.

¹⁰ διὰ τὸ ἀσύντακτον . . . εἶναι om. R.

for it is not possible to charge uphill nor to ride downhill.

(2) [*Foraging Expeditions*]

The general should be cautious in the matter of foraging expeditions, and not allow troops, when invading a rich hostile country, to search for plunder in an undisciplined manner; for the greatest misfortunes befall men acting in this way, since it has often happened that the enemy, falling on men scattered and without order in their eager search for booty, on account of this lack of order and the fact that they were loaded with their booty have killed many as they were retreating, unable to give aid to their comrades or to use their arms. If any men do plundering without the command of the general, they should be punished. When the general himself sends out foraging parties, he should send with the light-armed and unarmed men guards, both horse and foot, who shall have nothing to do with the booty but are to remain in formation and guard the foragers, that the return to camp may be safely accomplished.

¹¹ δυναμένοις ὅτε vGH.

¹² προνομεύειν ἐπιχειρήσωσιν vGH: ἐπιχειρήσουσιν Koraes.

¹³ κολαζέσθωσαν vGH.

¹⁴ αὐτὸ γέ μιν CR.

¹⁵ πέμπη vGH (πέμπη GH).

¹⁶ FKRGH: ἐνταττέτω v.

¹⁷ οἱ F.

¹⁸ ἀσχυλῆσονται Jos. Scaliger reports from an old ms.

¹⁹ παραφυλάξωσι v.

²⁰ ὑποχώρησις Koraes.

ONASANDER

γ'. [Περὶ κατασκόπων]¹

- 9 Εἰ δὲ συλλάβοι ποτὲ κατασκόπους, μὴ μιᾷ κε-
 χρήσθω γνώμη· ἀλλ', ἐὰν μὲν ἀσθενέστερα τὰ ἴδια
 ἤπερ² τὰ παρὰ τῶν πολεμίων εἶναι νομίζη,³
 κτεινάτω⁴ τούτους, ἂν⁵ δὲ καὶ ὄπλισμῶ καλῶ
 κεχρημένος ἢ καὶ παρασκευαῖς ἐντελέσει⁶ καὶ
 δυνάμει πολλῇ καὶ εὐεξίᾳ σωμάτων καὶ πειθηνίῳ
 στρατεύματι καὶ ἡγεμόσιν ἀρίστοις καὶ ἐμπειρίᾳ
 μεμελετημένῃ, παραλαβὼν τοὺς κατασκόπους καὶ
 ἐν κόσμῳ τὴν στρατιάν⁷ ἐπιδειξάμενος οὐκ ἂν
 ἀμάρτοι ποτὲ καὶ ἀθώους ἀποπέμψας.⁸ τὰ μὲν
 γὰρ πλεονεκτήματα τῶν ἀντιπολέμων⁹ ἀγγελλό-
 μενα φοβεῖσθαι συνηνάγκασεν, τὰ δ' ἐλαττώματα
 θαρρεῖν παρεστήσατο.

δ'. [Περὶ νυκτοφυλάκων]¹

- 10 Φύλακας δὲ καταταπτέτω καὶ πλείους, ἵν'¹⁰ ἐν
 μέρει διελόμενοι¹¹ τὴν τῆς νυκτὸς ὥραν οἱ μὲν
 ὑπνοῦν¹² οἱ δὲ γρηγορεῖν¹³ αἰρῶνται.¹⁴ οὔτε γὰρ
 ἀναγκαστέον οὔθ' ὑπισχνουμένοις πιστευτέον ὄλην
 ἀγρυπνήσειν¹⁵ νύκτα τοὺς αὐτούς.¹⁶ εἰκὸς γάρ¹⁷
 ποτε¹⁸ καὶ παρὰ γνώμην ἐνδιδόντων τῶν μελῶν
 11 αὐτόματον ὕπνον ἐπελθεῖν. ὀρθοὶ δ' ἐστῶτες
 φυλαττόντων.¹⁹ αἱ γὰρ καθέδραι καὶ ἀναπτώσεις

¹ Title om. FGH.

² τὰ ἴδια ἤπερ om. F: εἰ ENP: ἤπερ GH.

³ ἴσως παραχρῆμα after νομίζη A m² in margin.

⁴ κτεινάτω R.

⁵ ἐὰν ν (ἐὰν GH) ἂν F.

⁶ ἐντελέσει G: ἐν τελέσι H.

⁷ Schwebel: στρατείαν Ω.

⁸ ἀποπέμψαι F.

⁹ ἀντιπάλων νGH.

THE GENERAL, x. 9 - 11

(3) [*Spies*]

If the general should at any time capture spies, he should not employ any one single method in dealing with them. If he considers that his own army is weaker than that of the enemy, he should kill them, but if he has complete equipment of arms, thorough preparation for war, a powerful army, vigorous and disciplined, excellent officers, all trained by experience, he will make no mistake if, after making the spies examine his army drawn up in battle array, he occasionally even sends them away unharmed; for reported superiority of the enemy necessarily causes fear, but reported inferiority brings courage.

(4) [*Guards by Night*]

The general should appoint guards and a rather large number of them, that, by dividing the night into watches, some may sleep and some stand guard. Men must not be compelled to stand guard the entire night, nor even if they volunteer to do so must they be trusted; for it is only reasonable that sometimes, when the body is tired, sleep will come of its own accord, even against one's will. The guards must remain standing while on duty; for seats and

¹⁰ FEN: ἡ PGH: ἦν R.

¹¹ διελλόμενοι GH.

¹² ἕπνον vGH.

¹³ ἐγρήγορσιν vGH.

¹⁴ αἰροῦνται "quidam libri mss." (Schwebel).

¹⁵ ἀγρυπνήσαι vGH.

¹⁶ τοῦτοις for τοὺς αὐτοὺς F.

¹⁷ γὰρ ἂν vGH.

¹⁸ Om. R.

¹⁹ τῶν φυλασσόντων vPGH.

ONASANDER

συνεκλύουσαι¹ τὰ σώματα μαραίνουσιν εἰς ὕπνον, ἢ δ' ἀνάστασις² καὶ ὁ τόνος τῶν σκελῶν³ ἐγγρηγορσιν ἐντίθησι τῇ διανοίᾳ. καιόντων δ' οἱ φύλακες πυρὰ⁴ πορρωτέρω τῆς στρατοπεδείας· οὕτως γὰρ τοὺς μὲν προσιόντας⁵ διὰ τοῦ φωτὸς ἐκ πολλοῦ συνόψονται, τοῖς δ' ἐκ τοῦ φωτὸς ἐν σκότῳ τυγχάνοντες οὐκ ἀθρήσονται, μέχρις ἂν εἰς χεῖρας ἔλθωσιν.

ε'. [Περὶ λαθραίας ἀναχωρήσεως τοῦ στρατεύματος]⁶

13 Εἰ δὲ βούλοιτό ποτε⁷ νύκτωρ ἀναστήσαι τὸ στρατεύμα λανθάνων τοὺς πολεμίους, ἢ τόπους προκαταλαβέσθαι προαιρούμενος⁸ ἢ τοὺς ὄντας φεύγων⁹ ἢ μηδέπω¹⁰ βουλόμενος¹¹ εἰς ἀνάγκην ἐλθεῖν τοῦ μάχεσθαι, πυρὰ πολλὰ καύσας ἀναχωρεῖτω· βλέποντες μὲν¹² γὰρ οἱ πολέμοιοι τὰ φῶτα δοκοῦσι κατὰ χώραν αὐτὸν μένειν, ἀφωτίστου δὲ μεταξὺ¹³ γενομένης τῆς παρεμβολῆς ὑπόνοιαν ἀναλαβόντες,¹⁴ ὡς φεύγουσιν, ἐνέδρας¹⁴ τε προεκπέμπουσι καὶ διώκουσιν.

ς'. [Περὶ στρατηγῶν κοινολογουμένων τοῖς τῶν ἐναντίων στρατηγοῖς]⁶

14 Ἐὰν δ' ἐπὶ τῶν αὐτῶν μένων εἰς ὄψιν ἔρχηταί ποτε τῷ τῶν¹⁵ πολεμίων στρατηγῷ,¹⁶ κοινολογη-

¹ συλλύουσαι vGH: συλλύονται A m².

² δ' ἀνάστασις FG: δὲ ἀνάστασις H.

³ FGH: τῶν σκελῶν καὶ ὁ τόνος v.

⁴ FC (δὲ C): δὲ τῶν φυλάκων πυρὰ (πρὸ P) vPGH.

⁵ Schwebel: ἰόντας C: ὄντας Ω.

THE GENERAL, x. 11 - 14

reclining positions, relaxing the body, are conducive to sleep, but standing erect and keeping the legs stretched makes the mind wakeful. The guards must build fires at some distance from the camp. Thus because of the light they will see at a distance men advancing toward the camp, but those who come from the light will not perceive the guards, who are in the dark, until they fall into their hands.¹

(5) [*Secret Retreat of the Army*]

If the general desires to withdraw his army by night without the knowledge of the enemy, either to be the first to occupy a certain position or to escape from the position he is in, or to avoid the present necessity of battle, he should retreat leaving many fires burning; for as long as the enemy see the fires they believe that the army is remaining in the same place, but if the camp becomes dark while the retreat is going on, the enemy will suspect their flight, send ahead ambushes, and follow in pursuit.

(6) [*Parleys with the Generals of the Enemy*]

But if, while keeping his army in the same spot, he should come to a conference with the opposing

¹ This precept also derives apparently from Xenophon, *Cyropaedia*, iii. 3. 25. Compare Thucydides iii. 23. 3-4.

⁶ Title om. FGH. ⁷ παρὰ R. ⁸ προαιρουμένους R.
⁹ φ (space for five letters) P and "veteres membranæ"
(V? Rigaltius).
¹⁰ μὴ δέ πω F: μὴδὲ vGH: μὴ καὶ RA m².
¹¹ FEN: βουλομένοις PGH (v?).
¹² Om. vGH. ¹³ λαβόντες vGH.
¹⁴ ἐνέδρας . . . διώκουσιν' om. R.
¹⁵ N: om. τῶ F: om. τῶν Ω. ¹⁶ στρατηγῶν F.

ONASANDER

σόμενος, ὡς αὐτὸς εἰπεῖν ἢ ἀκοῦσαί τι βουλό-
 μενος, ἐκλεξάμενος¹ τοὺς κρατίστους καὶ ἀξιο-
 πρεπεστάτους τῶν νέων, εὐρώστους καλοὺς μεγά-
 λους, ὄπλοις² διαπρεπέσι κοσμήσας ἔχων² περὶ
 αὐτὸν³ ἀπαντάτω· πολλάκις γὰρ τοιόνδε τὸ
 πᾶν ἀπὸ μέρους ὀφθέντος⁴ ἠλπίσθη,⁵ καὶ οὐκ ἐξ
 ὧν ἤκουσεν ὁ στρατηγὸς ἐπέισθη, τί δεῖ ποιεῖν,
 ἀλλ' ἐξ ὧν εἶδεν⁶ ἐφοβήθη.

ζ'. [Περὶ αὐτομόλων]⁷

- 15 Τῶν δὲ αὐτομόλων εἶ τινας ἢ καιρὸν ἀφικ-
 νοῦνται μνηύσοντες ἢ ὥραν ἐπιθέσεως, ἢ ὁδὸν
 ἐπαγγέλλονται καθηγήσασθαι⁸ καὶ διὰ σκοπῶν⁹
 ἀοράτων τοῖς¹⁰ πολεμίοις ἄξειν, δήσας αὐτοὺς
 ἀγέτω,¹¹ τοῦτο ποιῶν σφισι¹² φανερόν, ὡς, εἴαν μὲν
 ἀληθεύσωσι καὶ ἐπὶ σωτηρίᾳ καὶ νίκη πάντα
 ποιήσωσι τοῦ στρατεύματος, λύσει τέ σφας καὶ
 δωρεὰς δώσει καταξίους,¹³ εἴαν δ' ἐξαπατήσωσι
 καὶ ψεύσωνται¹⁴ τοῖς σφετέροις ἐγχειρίσαι¹⁵ βου-
 λόμενοι τὸ στρατεύμα, παρ' αὐτὸν ἐκείνον τὸν
 καιρὸν ὄντες¹⁶ ἐν δεσμοῖς ὑπὸ τῶν κινδυνευόντων
 κατασφαγήσονται· πίστις γὰρ αὐτομόλου τι μνηύον-
 τος αὕτη βεβαιοτάτη, τὸ μὴ αὐτὸν εἶναι τῆς
 αὐτοῦ¹⁷ ψυχῆς κίριον, ἀλλὰ τοὺς ὀδηγουμένους.¹⁸

¹ Om. H.

² Köchly suggests *καὶ* before *ὄπλοις* and *καὶ οὕτως* before *ἔχων*.

³ Köchly: *αὐτὸν* FEMN: *αὐτῶν* PGH and "quidam mss." (Schwebel).

⁴ Köchly: *ὀφθὲν* Ω.

⁵ *ἐλπισθέν* F'.

⁶ *ἶδεν* F'.

⁷ Title om. FGH. ⁸ *ἢ ὥραν . . . καθηγήσασθαι* om. R.

⁹ *διασκοπῶν* F: *διὰ σκόπων* R: *ἴσως τύπων* C margin: *στῖβων* or *στενῶν* conij. Koraes.

THE GENERAL, x. 14 – 15

general, either to make or to receive some proposal, he should choose as an escort the strongest and finest-looking of the younger soldiers, stalwart, handsome and tall men, equipped with magnificent armour, and with these about him he should meet the enemy. For often from the view of a part the whole is judged to be like it, and a general does not determine his course of action by what he has heard, but is terrified by what he has seen.

(7) [*Deserters*]

If any deserters arrive in camp to tell of a suitable opportunity or hour for attack, or if they offer to act as guides over a road and assert that they will lead the army along it, unseen by the enemy, the general should lead these deserters with him securely bound, making it plain to them that, if they are truthful and bring safety and victory to the army, he will set them free and present them with fitting rewards, but that if they attempt to deceive him and wish to betray his army into the hands of their own friends, at that same 'suitable opportunity' they will be slain in their bonds by the endangered army. Confidence may be most safely placed in the word of a deserter, when he knows that his life is not in his own hands, but in the hands of those whom he leads.

¹⁰ Om. R. ¹¹ ἀγέτωι GH. ¹² FC: om. vGH.

¹³ FC: κατ' ἀξίαν v (καταξίαν GH). F indicates a break at this point. ¹⁴ ψεύσονται GH.

¹⁴ An old ms. reported by Scaliger: ἐγχειρήσαι Ω.

¹⁶ Om. vGH. ¹⁷ Köchly: αὐτοῦ F: ἐαυτοῦ vGH.

¹⁸ FC: ἡγουμένους vGH.

ONASANDER

γ'. [Περὶ τοῦ ὄραν καὶ τὴν τῶν πολεμίων
παρεμβολήν]¹

- 16 Ὀράτω δὲ καὶ τὴν τῶν πολεμίων παρεμβολὴν ἐμπείρως· μήτε γάρ, ἐὰν ἐν³ ἐπιπέδῳ καὶ κατὰ κύκλον ἴδη³ κείμενον βραχὺν τὴν περίμετρον καὶ συνεσταλμένον χάρακα,⁴ δοκίτω τοὺς πολεμίους ὀλίγους⁵ εἶναι — πᾶς γὰρ κύκλος ἐλάττω τὴν τοῦ σχήματος ὄψιν ἔχει τῆς ἐξ ἀναλόγου στερεομετρομένης θεωρίας, καὶ πλείους δύναται δέξασθαι τὸ ἐν αὐτῷ⁶ περιγραφόμενον εὖρος, ἢ ἰδῶν ἂν⁷ τις ὄψει τεκμήραιτο —, μήτε, ἂν αἱ πλευραὶ τοῦ χάρακος ἐπὶ μῆκος ἐκτείνωσι⁸ καὶ κατὰ τι μέρος στεναὶ τυγχάνωσιν ἢ σκολιαὶ καὶ πολυγώνιοι καὶ ὀξυγώνιοι,⁹ πολὺ πλῆθος ἐλπίζέτω· τῆς¹⁰ μὲν γὰρ στρατοπεδείας ἢ ὄψις μεγάλη φαίνεται, τοὺς δ' ἐν αὐτῇ περιειλημμένους ἄνδρας οὐ πάντως πλείονας ἔχει τῶν ἐν κύκλῳ περι-
- 17 γραφομένων. οἱ δ' ἐπὶ τῶν ὄρων καὶ λόφων χάρακες, ἐὰν μὴ συμφυεῖς¹¹ ὦσι πάντῃ, μείζους μὲν ὄρωνται τῶν ἐν τοῖς ἐπιπέδοις, ἐλάττους δὲ ἢ κατὰ τὴν ὄψιν ἄνδρας περιέχουσιν· πολλὰ γὰρ ἀνθρώπων ἐντὸς ἀπολείπεται γυμνὰ μέρη· τῶν γὰρ τοιούτων τόπων ἀνάγκη πολλὰ μὲν εἶναι βάραθρα, πολλὰ δὲ κρημνώδη¹² καὶ τραχέα καὶ ἀκατασκήνωτα, τοῦ δὲ χάρακος πρὸ τῶν ἀνθρώπων τιθεμένου, τούτου τὸ¹³ μῆκος εὐλόγως ἐπεκτε-
- 18 νεταί.¹⁴ μῆτ' οὖν, ἐπειδὴν ἴδη βραχὺν¹⁵ καὶ

¹ Title om. FGH.

² CEMN: om. FPGH.

³ ἦδη R.

⁴ κειμένην τάχα ἐν περιμέτρῳ καὶ συνεσταλμένῳ χάρακι vGH.

⁵ ἐλάττους vGH: om. πολεμίους R.

⁶ τὸν ἐαυτῷ F.

THE GENERAL, x. 16 - 18

(8) [*On the Inspection of the Enemy's Camp*]

The general should skilfully inspect the camp of the enemy. If he sees a circular palisade contracted into a small circumference, lying in a plain, he should not conclude that the enemy are few in number; for every circle appears to contain less than it actually does by the theory of proportionate geometrical contents,¹ and the space enclosed within a circle can hold more men than one would think to see it. If the sides of the palisade happen to be long and close together in certain parts, or crooked with many acute angles, he should not conclude that the camp contains a great number of men; for this type of camp appears large but has no more men within its walls in every case than circular camps have. Palisades on hills and mountains, unless compact in every respect, appear greater than those in plains, but they contain fewer men than the eye judges; for many parts of such camps are bare of men, since there must be many ravines in them and many steep and precipitous banks unsuitable for pitching tents, and as the palisade is built to defend the men, its length must be accordingly greater. The general, therefore, judging merely the position and shape of a camp,

¹ The author seems to be using of a plane figure a term properly applicable only to a solid.

⁷ Added by Koraes: om. Ω: *τις πάντως* R may retain a suggestion of it.

⁸ *ἐκτείνουσι* F.

⁹ *καὶ ὀξυγώνιοι* om. vGH.

¹⁰ *ἦς* F.

¹¹ *συνφυσῆς* H.

¹² Om. vGH.

¹³ *τοῦτο τὸ* vGH: *τοῦ* R: *τοῦ* A m².

¹⁴ *ἐπεκτείνουσι* vGH.

¹⁵ *ἐπειδὴν ἰδὴ βραχὺν* F: *ἐπει δὴν ἰδὴ βραχὺ* GH: *βραχὺ* vP.

ONASANDER

συνεσταλμένον, καταφρονείτω συλλογιζόμενος καὶ τὸν τόπον καὶ τὸ σχῆμα, μήτ', ἂν καὶ παραμήκη, κιταπληττέσθω.

- 19 Ταῦτα μέντοι γινώσκων¹ εὐκαίρῳ ποτὲ στρατηγία χρησάσθω, καὶ καταστρατοπεδεύσας ἐν ὀλίγῳ κατὰ τὸ προειρημένον σχῆμα, καί, εἰ δέοι, καὶ συνθλίψας τὸ στράτευμα μὴ προαγέτω μήτε² δεικνύτω³ τοῖς ἀντεστρατοπεδευκόσι,⁴ καὶ δὴ προκαλουμένοις εἰς μάχην μὴ⁵ ἔξαγέτω· δοκεῖτω
- 20 δὲ καὶ δεδιέναι. πολλάκις γὰρ οἱ πολέμοιοι καταφρονήσαντες ὡς ὀλίγων⁶ ὄντων τῶν ἐναντίων, ὄψει καὶ οὐκ ἐμπειρία⁷ στρατηγικῇ τὰ πράγματα κρίνοντας,⁸ ῥαθυμότερον ἀνεστράφησαν, ἀφυλάκτως καὶ ἀτάκτως τῆς ἰδίας προϊόντες⁹ παρεμβολῆς, ὡς οὐ τολμησόντων σφίσι τῶν πολεμίων ἐπέξελευσέσθαι, ἢ καὶ τῷ χάρακι περιστάντες¹⁰ πολιορκούσιν ἀπροσδόκητοι¹¹ τοῦ μέλλοντος ἐκχυθήσθαι πλήθους· ἢ δ' ἀνελπιστία τῶν δεινῶν ἀμελεστέροισ ἐποίησε τοὺς στρατιώτας. ἔνθα δεῖ¹² τὸν καιρὸν ἀρπάσαντα¹³ κατὰ πολλὰς ἐκδραμόντα¹⁴ τοῦ χάρακος πυλίδας ἐν τάξει τῶν ὑποκειμένων ἀνδρείως ἔχεσθαι πραγμάτων.
- 21 Ὁ δὲ εἰδὼς οὕτως στρατηγεῖν εἴσεται, κἂν ὑπὸ τῶν πολεμίων ἐν τοῖς αὐτοῖς καταστρατηγηθῆται, καὶ δρᾶσαι τι φρόνιμος ἔσται καὶ φυλάξασθαι προμηθής· ἐξ ὧν γὰρ αὐτὸς εἴσεται, τί δεῖ ποιεῖν, ἐκ τούτων ἑτέρου ποιούντος γινώσεται, τί χρῆ μὴ

¹ γινώσκων F. ² εἴτε F: μηδὲ Koracs.

³ Om. P "alii codices" (Schwebel).

⁴ ἀντεστρατοπεδευκόσι F: ἀντιστρατοπεδευκόσι v.

⁵ καὶ vGH. ⁶ FFNRGH: ὀλίγων P "alii codd."

⁷ οὐκ εμπειρία F: ἐκπειρία H. ⁸ κρίναντες K Koracs.

THE GENERAL, x. 18 – 21

should not be emboldened at the sight of a small contracted camp nor downhearted at the sight of an extended one.

With this knowledge he should make use of opportune strategy. Stationing his army in a small camp, according to the above-mentioned plan, and if necessary, even crowding the soldiers together, he should not lead them from the camp nor show them to the enemy encamped opposite, nor lead them into battle if the enemy challenge, but he should even give the impression that he is afraid. For often the enemy, growing bold in the belief that their opponents are few, judging by sight and not by strategic experience, behave thoughtlessly. They go forth from their camp carelessly and without discipline, believing that their opponents will not dare to come out and attack; or they even surround and blockade the palisade, unaware of the multitude of men about to pour forth upon them; and with no expectation of danger soldiers become heedless. Then, seizing a favourable opportunity, the army must rush forth from the many little gates of the palisade, and in battle array courageously grapple with the task before them.

The general, having this knowledge, will know how to do his part, and even if he is out-generaled in these same matters, will be both wise in action and prudent in devising protection; for from the knowledge that instructs him in what he must do, he will know, when his opponent is trying to do this to him, what he must not himself suffer, since

⁹ προϊώντας R.

¹¹ ἀπροσδόκητον F.

¹² δὴ F.

¹⁰ FC: om. vGH.

¹³ ἀπ'άσσαντας vFGH.

¹⁴ FFGH: ἐκδραμόντας v.

ONASANDER

παθεῖν· αἱ γὰρ ἴδιαι πρὸς τὸ λυπεῖν ἐμπειρίαι καὶ τὰς τῶν πέλας ἐπινοίας τεκμαίρονται.

θ'. [Περὶ ἀπορρήτων]¹

- 22 Προάγειν δ' εἰ δέοι² νύκτωρ ἢ μεθ' ἡμέραν ἐπὶ τι τῶν ἀπορρήτων, ἢ φρούριον³ ἢ πόλιν ἢ ἄκρα⁴ ἢ παρόδους καταληψόμενον⁵ ἢ τι τῶν ἄλλων⁶ δράσοντα,⁷ ἃ⁸ διὰ τάχους λαθόντα⁹ τοὺς πολεμίους, ἄλλως δ' οὐκ ἔστι πρᾶξι, μηδενὶ προλεγέτω, μήτ' ἐπὶ τί μήτε τί ποιήσων ἄγει¹⁰ τὴν στρατιάν, εἰ μή¹¹ τισι τῶν ἡγεμόνων ἀναγκαῖον εἶναι νομίζοι
- 23 προειπεῖν. γενόμενος δ' ἐπ' αὐτῶν τῶν τόπων ἐγγὺς ὄντος τοῦ παρ' ὃν δράσαι τι δεῖ καιροῦ¹² διδότην τὸ παράγγελμα καὶ τί δεῖ πράττειν σημαίνετω· ταχὺ δὲ τοῦτο ἔστω¹³ καὶ δι' ὀλίγης ὥρας· ἅμα γὰρ οἱ ἡγεμόνες ἀκούουσι καὶ οἱ ὑποτε-
- 24 ταγμένοι τούτοις¹⁴ ἴσασι. ἄφρων δὲ καὶ ἀτελής, ὅστις ἂν πρὸ τοῦ δέοντος εἰς τὸ πλῆθος ἀνακοινώσῃται τὴν πρᾶξιν· οἱ γὰρ πονηροὶ μάλιστα περὶ¹⁵ τοὺς τοιούτους αὐτομολοῦσι καιρούς, παρ' οὓς ἐροῦντές τι καὶ¹⁶ μηνύσοντες οἴονται τιμῆς καὶ δωρεᾶς τεύξεσθαι¹⁷ παρὰ τῶν πολεμιῶν· οὐκ ἔστιν δ' ἀφ' οὗ στρατεύματος οὐκ ἀποδιδράσκουσι πρὸς ἀλλήλους δοῦλοὶ τε καὶ ἐλεύθεροι κατὰ πολλὰς προφάσεις, ἅς¹⁸ ἀνάγκη παρέχεσθαι πόλεμον.

¹ Title om. FGH.

³ φρουρίων F.

⁵ καταλειψόμενον H.

⁷ δράσαντα FPGH (corr. A?).

⁹ λαθεῖν vGH.

² δὲ ἤδη vGH; δ: K.

⁴ ἀκραν vGH.

⁶ ἕλων D.

⁴ Added by Koraes.

¹⁰ FC: ἄγειν vPGH.

¹¹ εἰ δὲ μή F.

personal experience in inflicting damage warns of the designs of others.

(9) [*Secret Plans*]

If the general must make a march by night or by day for some secret purpose, to seize a fortress, city, height, or pass, or to do anything else that must be done quickly without the knowledge of the enemy, which otherwise could not be done at all, he must tell no one beforehand against what place or for what purpose he is leading his army, unless he considers it necessary to warn some of the higher officers in advance. But when he has reached the spot and the moment is near at hand when he must act, he must give his orders and point out what is to be done. These orders must be quick and brief, for at the same instant that the leaders receive instructions their subordinates also know them. Thoughtless and futile is he who communicates his plan to the rank and file before it is necessary; for worthless scoundrels desert to the foe especially at critical times, when, by revealing and disclosing secrets, they believe they will receive honour and reward from the enemy. There is no army in which both slaves and freemen do not desert to the other side on the many occasions that war necessarily affords.

¹² Koræes: *ὄντων τὸ παρὸν δράσαι τί δέῃ καιροῦ* Ω: *ὄντων, παρ' ὃν δράσαι τί δέῃ καιρὸν* Schwebel after Scaliger.

¹³ Koræes: *ἔσται* Ω.

¹⁴ F: *τούτους οἱ ὑποταγμένοι* PR: *τούτοις οἱ ὕ. ν: οἱ ὕ. τούτους* GH.

¹⁵ AB Köchly: *παρὰ* Ω.

¹⁶ *καιροῦς' ἀρρῶνται ἔτι καὶ* F.

¹⁷ *τεύξασθαι* EN "alii codd." GH.

¹⁸ Om. vGH.

ONASANDER

ι'. [Περὶ τῆς πρὸ μάχης ἐπισκέψεως τῶν ἱερῶν]¹

- 25 Μήτε δὲ εἰς πορείαν ἐξαγέτω τὸ² στράτευμα
 μήτε πρὸς μάχην ταττέτω, μὴ πρότερον θυσάμενος·
 ἄλλ' ἀκολουθούντων αὐτῷ³ θύται⁴ καὶ μάντεις.
 ἄριστον μὲν γὰρ καὶ αὐτὸν ἐμπείρως ἐπι-
 σκέπτεσθαι δύνασθαι τὰ ἱερά·⁵ ῥᾶστόν γε μὴν
 ἐν τάχει μαθεῖν ἔστιν καὶ αὐτὸν αὐτῷ⁶ σύμ-
 26 βουλον ἀγαθὸν γενέσθαι. γενομένων δὴ καλῶν
 τῶν ἱερῶν ἀρχέσθω πάσης πράξεως καὶ καλείτω
 τοὺς ἡγεμόνας πάντας ἐπὶ τὴν ὄψιν τῶν ἱερῶν, ἵνα
 θεασάμενοι τοῖς ὑποταττομένοις⁷ θαρρεῖν λέγοιεν
 ἀπαγγέλλοντες,⁸ ὡς οἱ θεοὶ κελεύουσι μάχεσθαι·
 πάνυ γὰρ ἀναθαρροῦσιν αἱ δυνάμεις, ὅτ' ἂν μετὰ
 τῆς τῶν θεῶν γνώμης ἐξίεναι νομίζωσιν ἐπὶ
 τοὺς κινδύνους· αὐτοὶ γὰρ ὀπιπεύονται⁹ κατ' ἰδίαν
 ἕκαστος καὶ σημεῖα καὶ φωνὰς παρατηροῦσιν,
 ἧ δ' ὑπὲρ πάντων καλλιέρησις καὶ τοὺς ἰδία
 27 δυσθυμοῦντας¹⁰ ἀνέρωσεν. εἰ δ' ἐπὶ τούναν-
 τίον τὰ ἱερά γένηται,¹¹ μένει ἐπὶ τῶν αὐτῶν, κἂν
 σφόδρα τι ἐπείγῃ, πᾶν ὑπομένειν τὸ δύσχρηστον
 —οὐθὲν γὰρ δύναται παθεῖν χεῖρον, ὧν προμηνύει
 τὸ δαιμόνιον—, ὡς, ἂν γέ τι κρεῖττον¹² ἔσεσθαι
 μέλλῃ τῶν παρόντων,¹³ ἀνάγκη καλλιερεῖν, θύεσθαι
 δὲ τῆς αὐτῆς ἡμέρας πολλάκις· ὦρα γὰρ μία καὶ
 ἀκαρῆς χρόνος ἢ φθάσαντας ἐλύπησεν¹⁴ ἢ ὑστε-
 28 ρήσαντας.¹⁵ καὶ μοι¹⁶ δοκεῖ τὰς κατ' οὐρανὸν

¹ Title and break om. FGH.

² Om. F.

³ αὐτῶν R.

⁴ θύσαι R.

⁵ F indicates a break here.

⁶ Köchly: αὐτῷ Ω (αὐτῷ GH): αὐτον αὐτῷ F.

⁷ τοὺς ὑποταττομένους vGH: τοὺς ὑποτεταγμένους D.

⁸ ἀπαγέλον . . R.

(10) [*Taking the Omens before Battle*]

The general should neither lead his army on a journey, nor marshal it for battle, without first making a sacrifice; in fact, official sacrificers and diviners should accompany him. It is best that the general himself be able to read the omens intelligently; it is very easy to learn in a brief time, and thereby become a good counsellor to himself. He should not begin any undertaking until the omens are favourable, and he should summon all his officers to inspect the offerings, that, after seeing, they may tell the soldiers to be of good courage, since the gods command them to fight. Soldiers are far more courageous when they believe they are facing dangers with the good will of the gods; for they themselves are on the alert, every man, and they watch closely for omens of sight and of sound, and an auspicious sacrifice for the whole army encourages even those who have private misgivings. But if the omens are unfavourable, he must remain in the same place, and if he is hard pressed for time he must patiently submit to every inconvenience—for he can suffer nothing worse than what Fate indicates beforehand,—since, if his condition is going to improve, he must have favourable signs in a sacrifice and he must sacrifice several times on the same day; one hour, even one minute, ruins those who start too soon or too late. And it seems to me that the

⁹ ὅτι τεύξονται KA m^d GH and all Schwebel's mss.

¹⁰ δυσφημοῦντας vGH (-μοῦντας H).

¹¹ γίνηται GH: γίγνηται vA m^d.

¹² From κρείτ. το ὁ στρατηγός XIII. 1 is missing in G.

¹³ τῶν παρόντων μέλλη vH.

¹⁴ ἐαυτῆς ἐν F.

¹⁵ στερήσαντας R.

¹⁶ ὑστερήσαντάς μοι F.

ONASANDER

ἀστέρων κινήσεις καὶ ἀνατολὰς καὶ δύσεις καὶ σχημάτων ἐγκλίσεις¹ τριγώνων καὶ τετραγώνων καὶ διαμέτρων ἢ θυτική διὰ σπλάγγνων ἀλλοιομόρφω θεωρία προσημαίνει, ὧν αἱ παρὰ μικρὸν διαφοραὶ καὶ δυνάμεις καὶ ἀποθειώσεις² ἐν ἡμέρᾳ μιᾷ μᾶλλον δέ³ ὥρα καὶ βασιλεῖς ἐποίησαν καὶ αἰχμαλώτους.

XI. α'. [Περὶ τοῦ ὅτι δεῖ τῶν πολεμίων σχηματιζομένων φεύγειν μὴ ἀπλῶς καὶ ὡς ἔτυχεν ἔχεσθαι τῆς διώξεως]⁴

Ἐπειδὴ δὲ πολλάκις θυομένοις ὡς μὲν εἰς μάχην καλὰ γίνεται τὰ ἱερά, διὰ δὲ μάχης ὄλον ἐνίοτε στρατευμάτων ὄλεθρον προσημαίνει, τῶν ἀναγκαιοτάτων⁵ ἡγοῦμαι περὶ⁶ τούτου φράσαι. τῆς γὰρ συμπάσης οἰκουμένης πολλὰς καὶ παντοίας εἶναι συμβέβηκεν ἰδέας τόπων, ἀδηλον δέ, ἐν ὁποίοις⁷ ἕκαστοι πολεμήσουσιν· καὶ τῆς μὲν σφῶν⁸ αὐτῶν ἐμπειρίαν ἔχουσι⁹ χώρας ἀνθρωποι,¹⁰ τὴν δ' ἄλλοτρίαν οὐκ ἴσασι.¹¹ πολλάκις δ' εἰ¹² στρατηγὸς ἀκούσας μιᾶς ἡμέρας ὁδὸν ἀπέχειν τοὺς πολεμίους ἀναστήσας ἄγει τὸν στρατόν, ἐπειγόμενος διὰ μάχης ἐλθεῖν τοῖς πολεμίοις,¹³ τῶν δ' ὑποχωρούντων ἐπίτηδες καὶ μὴ μενόντων,¹⁴ ὡς κατορρωδοῦσιν ἔπεται, τῶν δέ¹⁵ ταῦτό¹⁶ τοῦτο ποιοούντων, ἕως¹⁷ ἔλθωσιν εἰς δυσχωρίας καὶ

¹ ἐκκλίσεις R: ἐκλίσεις A m².

² ἀποθεώσεις K: ἀποθέσεις Koraes.

³ δ' Köchly.

⁴ Title om. FP: in margin in HAPRM (and therefore in G) after the first line of § 4.

⁵ ἀναγκαίων vH.

⁶ Koraes suggested καὶ before περὶ.

motions of the heavenly bodies, their risings and settings, and their positions—trine, square, and in opposition—are indicated by the art of extispicy, through another form of observation, and that trifling differences in these things have, in a single day, or rather in a single hour, led to power and deification, and have made both kings and captives.

XI. (1) [*Pursuit of an apparently fleeing Enemy must not be careless and haphazard*]

Since frequently the omens from a sacrifice are favourable for battle and yet sometimes foretell the complete destruction of the army through battle, I have considered it of the utmost necessity to say a few words on this point. The topography of the inhabited world differs widely in its various parts, and it is impossible to foresee in what sort of country a war will occur. Every man is well acquainted with his own country but not with foreign countries. Often a general, on hearing that the enemy are but a day's march distant, will call out his troops and lead them forward, hurrying to come to close quarters with the enemy, who, purposely retreating, do not make a stand against him; and so he assumes that they are afraid and pursues them. This continues until they come into a broken country,

⁷ τοίοις v: ποίοις H.

⁸ σαφῶς Rigaltius and "alii codd. ut vid."

⁹ ἔχουσιν H.

¹⁰ οἱ ἄνθρωποι A m².

¹¹ Ἰσασιν HA m² (v?), but F' writes Ἰσασι πολλάκις without a stop.

¹² δ' ἢ F': corr. A: δὲ v: δὴ H.

¹³ FC: ἀναστήσας . . . πολεμίοις om. vH Saguntinus Camerarius.

¹⁴ κενόντων R.

¹⁵ δὴ F.

¹⁶ ταυτὸ F': αὐτὸ vH.

¹⁷ Kornes conj. ἕως ἄν.

ONASANDER

περικεκλεισμένους ὄρεσι τόπους, ἐπίκειται μηδὲν
 ὑφορώμενος, εἶτα ἐμβαλῶν¹ εἰς τοὺς τόπους
 ὑπὸ τῶν πολεμίων ἀπεκλείσθη τῆς εἰσβολῆς,²
 ἢ³ τὸ στράτευμα εἰσῆλθε, καὶ καταλαβόμενοι
 τὰς τε εἰς τοῦμπροσθεν⁴ διόδους καὶ κύκλῳ τὰ
 μετέωρα πάντα κατασχόντες, ὥσπερ ἐν ζωγρείῳ⁵
 τινὶ συνεπέδησαν μὲν⁶ τοὺς πολεμίους,⁷ ὁ δὲ
 παριῶν⁸ μὲν ὑπὸ τῆς ὀρμῆς ἐφέρετο δοκῶν ἐπι-
 κείσθαι φυγομαχοῦσι τοῖς πολεμίοις, οἷς⁹ προσ-
 ελθῶν¹⁰ οὐκ ἔγνω, μετὰ δὲ ταῦτα περιβλεψάμενος
 τὰ τε¹¹ πρόσω καὶ ὀπίσω καὶ παρὰ πλευράν,
 καὶ πάντα πλήρη θεασάμενος πολεμίων ἢ συνη-
 κοντίσθη μετὰ τοῦ στρατεύματος, ἢ ἀπομάχεσθαι
 μὴ δυνάμενος καὶ μὴ παραδιδούς λιμῶ διέφθειρεν
 πάντας, ἢ παραδοὺς κυρίους ἐποίησε τοὺς πολεμίους
⁴ τοῦ ὅ τι¹² βούλονται διαθεῖναι. δεῖ τοίνυν τὰς
 ὑποχωρήσεις ὑφορᾶσθαι τῶν πολεμίων καὶ μὴ
 ἀπειροκάλως ἔπεσθαι καὶ¹³ περιβλέπεσθαι δὲ μᾶλ-
 λον τοὺς τόπους ἢ τοὺς πολεμίους καὶ δι' ὧν
 ἄγει χωρίων¹⁴ ὄραν, ἐπιλογίζεσθαι¹⁵ δ'¹⁶ ὅτι ταύτη
 πάλιν ὑποστρέψαι δεῖ, καὶ ἦτοι¹⁷ μηδ' εἰσβάλλειν,
 ἀλλ' ἀποτρέπεσθαι τῆς πορείας, ἢ εἰσβάλλοντα
 προορᾶν καὶ εἰς¹⁸ τὰς ὑπερβολὰς καὶ τοὺς συνάπτον-
 τας αὐχένας τῶν ὄρων ἀπολείπειν¹⁹ τοὺς παρα-
 φυλάττοντας, ἢ ἀσφαλῆς²⁰ σφισιν ἢ ἀνακομιδῇ

¹ βαλῶν F.

² Kœhly: ταῖς εἰσβολαῖς Ω.

³ (v?) Kœhly: ἢ F¹H.

⁴ εἰστοῦμπροσθεν F: εἰς τοῦνομα πρόσθεν R.

⁵ NRE, (margin) Saguntinus: ζωρωτινὶ F: ζωγῶγρω P (in marg. ζωρωῦ): ζωγῶγρω H (in marg. ζωρωῦ? very faint): ζωγραφείω E (text). Rigaltius also quotes ζωρωῦ from the margin of "veteris membr." (= V?). ⁶ Om. vH.

⁷ F leaves after this word space for three or four letters.

surrounded by mountains on all sides, and the general, unsuspecting, still attacks them; next, as he marches against their positions, he is cut off by the enemy from the road by which he led his army in. They seize the passes in front of him, and all the heights round about, and thus confine their enemies in a sort of cage. But the general is carried away by his impetuosity, in the belief that he is pursuing a fleeing enemy, without noticing whom he is approaching; and later, on looking before and behind and on both sides, and seeing all the hillsides full of the enemy, he and his army will be destroyed by javelins, or, unable to fight and unwilling to surrender, he will cause all to die of hunger, or by surrender enable the enemy to dictate whatever terms they wish. Therefore retreats on the part of the enemy should be suspected and not stupidly followed; the general should observe the country rather than the enemy, and notice through what sort of terrain he is leading his forces; and he should take into consideration that it is necessary to return by the same road by which he came, and should either refrain from advancing and turn aside from the route, or, if he does advance, he should take precautions, leaving forces to hold the mountain passes and connecting defiles in order that his return may

⁸ Kochly: παρών Ω (πυρών H): πρότερον Koræes.

⁹ FCD: ὡς R: ὅς EKN: οἱ H Rigaltius.

¹⁰ FCD: προελθῶν v: προέλθῶν H. ¹¹ τὰ τε om. vH.

¹² Schwebel: τουτὶ F: τοὺς θτι v: τοὺς ὅ τι HR: ἐς θτι E.N.

¹³ ἔχασθαι (om. και) vH.

¹⁴ FCH: χῶρον Pv: χῶρον A m²: δι' ὃν ἀγει χῶρον R.

¹⁵ ὑπολογίζεσθαι vH. ¹⁶ τε Koræes. ¹⁷ εἴτε vH.

¹⁸ ἢ εἰσβάλλοντα προορᾶν and εἰς om. F: εἰσβάλλοντο A m².

¹⁹ ἀπολίπειν PH.

²⁰ ἀσφαλεῖς H.

ONASANDER

5 γίγνηται. ταῦτα δ' εἰρήσθω καὶ τοῦ καταστρα-
τηγεῖν οὕτως εἶνεκα¹ καὶ τοῦ² μὴ καταστρα-
τηγεῖσθαι.³ καλὸν μὲν γὰρ καὶ τὸ λαβεῖν οὕτω
δύνασθαι πολεμίους, ἀναγκαῖον δὲ τὸ μὴ ληφθῆναι.⁴

β'. [Περὶ τοῦ προσίεσθαι τοὺς ἀπαγγέλλοντάς τι]⁵

6 Προσιέσθω δὲ καὶ πάντα τὸν βουλόμενον τι⁶
ἀπαγγέλλειν καὶ δοῦλον καὶ ἐλεύθερον καὶ νύκτωρ
καὶ μεθ' ἡμέραν καὶ ἐν' πορεία καὶ ἐν κατασκηνώσει
καὶ ἀναπαυόμενος καὶ ἐπὶ λουτροῦ καὶ ἐπὶ τροφῆς.⁸
οἱ γὰρ ἀναβαλλόμενοι καὶ δυσπρόσιτοι καὶ τοῖς
ὑπηρέταις τοὺς προσιόντας ἀνακόπτειν⁹ κελεύον-
τες πολλῶν καὶ μεγάλων¹⁰ εἰκότως διαμαρτά-
νουσι πραγμάτων, ἧ καὶ τοῖς ὅλοις ῥαθυμοῦντες
σφάλλονται· πολλάκις γὰρ ἐν ὄξει τὸ δυνάμενον
καιρῶ φθασθῆναι¹¹ πάρεισιν τινες μηνύοντες.

XII. [Περὶ ἀριστοποιίας]¹²

Ἀντιστρατοπεδεύων δὲ πολεμίῳ¹³ χάρακι μηδὲ
τῆς κατὰ καιρὸν ἀριστοποιίας¹⁴ ἀμελείτω.³ εἰάν
μὲν γὰρ ἐφ' ἑαυτῷ νομίζῃ τὸ ὅτε βούλεται τὸ
στράτευμα πρὸς μάχην ἐκτάττειν εἶναι, καὶ¹⁵

¹ F: ἔνεκα vH.

² FH: περὶ τοῦ v: καὶ περὶ τοῦ καταστρατηγεῖν τούτων
ἔνεκα K.

³ F indicates a break here.

⁴ λειφθῆναι F.

⁵ Koraes apparently added the title, for it does not appear
in FH, and even Rigaltius and Schwebel have merely "De
nuntiis admittendis."

⁶ τὸ HRA m².

⁷ Om. vH.

⁸ ἐπιστροφῆς F.

⁹ FH Leo. *Tactica*, xvi. 21: ἀνακόπτειν RA m²: ἀνα-
κάμπτειν DEKN.

¹⁰ μεγάλων καὶ vH.

THE GENERAL, XI. 5 - XII. 1

be safe. This advice is given for the purpose both of outwitting the enemy by these tactics and of not being outwitted oneself; for though it is a fine thing to be able in this fashion to ensnare the enemy, yet it is absolutely essential to avoid being ensnared oneself.

(2) [*Receiving Messengers*]

The general should receive every man who wishes to report anything, whether slave or freeman, by night or day, on the march or in camp, while resting, in the bath, or at table. For generals who procrastinate and are difficult of access, and who order their servants to keep out those who come to see them, naturally either miss many important opportunities or even through their negligence suffer complete ruin; for often men bring information at a critical moment about something that can be frustrated in the nick of time.¹

XII. [*Meal-times*]

The general, if encamped opposite the camp of the enemy, should not be careless of the proper time at which to serve meals. For if he considers that it lies with him to lead out his troops to battle

¹ Alexander, on being asked how he conquered Greece, replied, *μηδὲν ἀναβαλλόμενος*, 'By never putting anything off' (Schol. A on Homer's *Iliad* ii. 435).

¹¹ FH: φασθῆναι v: φρασθῆναι DR Koraes: *πραχθῆναι* conj. Koraes. ¹² Title om. FH.

¹³ *πολεμῶ* F: *πολεμῶν* vH Köchly.

¹⁴ *ἀριστοποσίας* F.

¹⁵ Del. Koraes.

ἡνίκα¹ ἂν ἐθέλη,² παραγγελλέτω ταῖς δυνάμεσιν ἀριστοποιεῖσθαι· ἐὰν δὲ εἰς τοσαύτην ἀνάγκην ἐληλυθὼς τυγχάνη διὰ τινος τόπους ἢ χάρακος ἀσθένειαν ἢ τινος ἄλλας αἰτίας, ὥστ' ἐπὶ τοῖς πολεμίοις ἀπολελεῖφθαι τὸ³ ἐξάγειν ὁπότε προαιροῦνται καὶ τὴν ἀνάγκην σφίσιν ἐπιτιθέναι τοῦ τὰ ὄπλα λαμβάνειν καὶ ἀντιπαρατάττεσθαι, μὴ ὀκνεῖτω καὶ ἔωθεν ἀριστοποιεῖσθαι σημαίνειν, μὴ φθάσωσιν νήσισις ἐπιθέντες οἱ πολέμιοι τὴν
 2 ἀνάγκην τοῦ μάχεσθαι. καὶ τὸ σύνολον οὐκ ἐν μικρῷ⁴ θετέον οὐδὲ παρορατέον τὴν τῶν τοιούτων πρόνοιαν· ἐμφαγόντες γὰρ στρατιῶται μετρίως, ὥστε μὴ πολὺν ἐνφορτίσασθαι⁵ τῇ γαστρὶ κόρον, δυναμικώτεροι πρὸς τὰς μάχας εἰσίν· πολλάκις καὶ⁶ παρὰ τοῦθ' ἠττήθη στρατόπεδα τῆς⁷ ἰσχύος ἐλλειπούσης⁸ διὰ τὴν ἔνδειαν, ὅταν μὴ ἐν⁹ ὄξει καιρῷ κρίνηται τὰ τῆς μάχης, ἀλλὰ δι' ἡμέρας ὄλης λαμβάνη¹⁰ τὸ τέλος.

XIII. [Περὶ τοῦ εἶναι τὸν στρατηγὸν εὖθυμον ἐν ταῖς δυσπραγαίαις]¹¹

· Ὅτ' ἂν δέ τις ἐμπέσῃ δυσθυμία στρατεύμασι¹² καὶ φόβος ἢ συμμαχίας τοῖς πολεμίοις ἀφιγμένης¹³ ἢ προτερήματός σφισι¹⁴ γεγονότος, ὃ¹⁵ στρατηγὸς τότε δῆ¹⁶ μάλιστα τοῖς στρατιώταις ἰλαρὸς καὶ
 2 γεγηθὼς καὶ ἀκατάπληκτος φαινέσθω.¹⁷ αἱ γὰρ ὄψεις τῶν ἡγεμόνων συμμετασχηματίζουσι τὰς

¹ ἡνίκα¹ Köchly.

² θέλη ν (θέλη Η).

³ Om. vH.

⁴ FH: σμικρῷ ν.

⁵ F: ἐνφορτίσαι Η: ἐμφορτίσαι ν: ἐνφορτώσαι R.

⁶ γὰρ καὶ vH.⁴

⁷ τὴν R.

⁸ ἐλλειπούσης (Schwebel) Koraes.

⁹ FC: om. vH.

THE GENERAL, XII. 1 – VIII. 2

whenever he wishes, he may set a meal hour for his troops at whatever time he wishes. But if he should chance to have come into such extremities, because of the terrain, or the weakness of his camp, or for some other reason, that it is left in the power of the enemy to attack whenever they desire, and to compel his army to seize their arms and draw up for defence, he should not hesitate to order the first meal at sunrise, lest the enemy, by a prior attack, force his men to fight while still hungry. On the whole, this matter must not be considered of slight importance nor should a general neglect to pay attention to it; for soldiers who have eaten moderately, so as not to put too great a load into their stomachs, are more vigorous in battle; armies have often been overpowered for just this reason, their strength failing for lack of food—that is, when the decision rests, not on a moment's fighting, but when the battle lasts throughout the entire day.

XIII. [*Courage on the Part of the General when in Adversity*]

Whenever despondency or fear has fallen on an army because the enemy has received reinforcements or gained an advantage, then especially the general should show himself to his soldiers gay, cheerful, and undaunted. For the appearance of the leaders brings about a corresponding change in the minds

¹⁰ λαμβάνει vH.

¹² στρατεύματι Köchly.

¹⁴ εἰς τι vPH.

¹⁶ FFN: δεῖ vPH (a lacuna in G but the top of δ and a circumflex accent can be seen).

¹⁷ Koraes: φαίνεσθαι vGH: om. F.

¹¹ Title om. F: in margin H.

¹³ FENRH: ἀφιγμένοις v.

¹⁵ With this word G resumes.

ONASANDER

ψυχὰς τῶν ὑποταττομένων,¹ καὶ στρατηγοῦ μὲν εὐθυμουμένου² καὶ ἰλαρὸν βλέποντος³ ἀναθαρρεῖ καὶ τὸ⁴ στρατόπεδον ὡς οὐδενὸς ὄντος δεινοῦ,⁵ κατεπτηχότος δὲ καὶ λυπουμένου συγκαταπίπτουσι ταῖς διανοίαις ὡς μεγάλου σφίσι κακοῦ
3 προφαινομένου. διὸ χρή πλέον τῷ σχήματι τοῦ προσώπου στρατηγεῖν τὴν τοῦ πλήθους εὐθυμίαν ἢ τοῖς λόγοις παρηγορεῖν· λόγοις μὲν γὰρ πολλοὶ καὶ⁶ ἠπίστησαν ὡς τοῦ καιροῦ πεπλασμένοι εἶνεκεν,⁷ ὄψιν δὲ θαρσοῦσαν⁸ ἀνυπόκριτον εἶναι νομίζοντες ἐπιστώσαντο τὴν ἀφοβίαν· ἀγαθὴ δὲ⁹ ἢ ἐξ ἀμφοῖν¹⁰ ἐπιστήμη τοῦ τε εἰπεῖν, ἀ¹¹ δεῖ, καὶ ὀφθῆναι, ὅποιον δεῖ.

XIV. α'. [Πότε δεῖ¹² φόβον ἐμβάλλειν τῷ στρατεύματι τῷ ἰδίῳ τὸν ἀπὸ τῶν ἐναντίων]¹³

Καθάπερ γε μὴν ἐν καιρῷ στρατεύματος ἀναθάρσησι¹⁴ ὤνησεν, οὕτως καὶ φόβος ὠφέλησεν. ὅτ' ἂν γὰρ ῥαθυμῇ στρατόπεδον καὶ ἀπειθέστερον ἢ τοῖς ἡγουμένοις, τὸν¹⁵ ἀπὸ τῶν πολεμίων¹⁶ ὑποσημαίνειν δεῖ¹⁷ κίνδυνον, οὐχ ἡκιστα φοβεροποιούντα τὴν ἐκείνων ἐφεδρείαν· οὐ γὰρ δειλοὺς ἔσται¹⁸ ποιεῖν οὕτως, ἀλλὰ ἀσφαλεῖς· ἐν μὲν γὰρ ταῖς δυσθυμίαις θαρρεῖν ἀναγκαῖον, ἐν δὲ ταῖς ῥαθυμίαις φοβεῖσθαι· τοὺς μὲν γὰρ δειλοὺς ἀνδρείους ποιεῖ, τοὺς δὲ θρασεῖς¹⁹ προ-

¹ ὑποτεταγμένων vGH.

² εὐθύμου vGH.

³ FENGH: βλέποντες Pn.

⁴ FGH: om. v.

⁵ ὡς οὐδενὸς ὄντος δεινοῦ om. Camerarius.

⁶ καὶ πολλοὶ R m².

⁷ ἔνεκεν GH Köchly.

⁸ Ω: θάρρους F: θαρροῦσαν Köchly.

⁹ δ' Köchly.

¹⁰ ἀμφοῖς A m².

of the subordinates, and if the general is cheerful and has a joyful look, the army also takes heart, believing that there is no danger; but should he have a frightened, worried appearance, the spirits of the soldiers fall with his, in the belief that disaster is impending. On this account, the general must inspire cheerfulness in the army, more by the strategy of his facial expression than by his words; for many distrust speeches on the ground that they have been concocted especially for the occasion, but believing a confident appearance to be unfeigned they are fully convinced of his fearlessness; and it is an excellent thing to understand these two points, how to say the right word and how to show the right expression.

XIV. (1) [*When one's own Army must be made to fear the Enemy*]

Just as the recovery of courage at a crucial moment benefits an army, so also fear is advantageous. For whenever an army becomes idle and inclined to disobey its officers, the general should suggest the danger from the enemy, especially by representing their reserves to be formidable. It will not be possible thus to make the soldiers cowardly but only steady, since in despondency it is necessary to be of good courage, but in idleness to fear; for fear makes cowards bold and the rash cautious.

¹¹ *στει* vGH: Köchly suggests *οια*. ¹² Om. EN.

¹³ Title om. F: after *ώφέλησεν* GHAP (in text GH).

¹⁴ *αναθάρρησις* vGH. ¹⁵ *των* F.

¹⁶ *πολέμων* F. ¹⁷ Om. R.

¹⁸ *έστι* GH A m². ¹⁹ FKR: *θαρσεΐς* vGH.

ONASANDER

2 μηθεῖς. ἀμφότερα δὲ¹ συμβαίνει στρατοπέδοις, καὶ οὕτως καταπεπληῆχθαι πολεμίους ὥστε μηδὲν ἐθέλειν τολμᾶν, καὶ οὕτως καταφρονεῖν² ὥστε μηδὲν φυλάττεσθαι· πρὸς ἑκάτερον δὲ δεῖ τὸν στρατηγὸν ἡρμόσθαι καὶ εἰδέναί, πότε δεῖ τάντιπαλα ταπεινὰ³ καὶ λόγῳ καὶ σχήματι ποιεῖν, καὶ πότε αὐτὰ⁴ δεινὰ καὶ φοβερώτερα.

β'. [Περὶ τὸ θαρρύνειν τὸ δεδιὸς στράτευμα]⁵

3 Μελλούσης δὲ μάχης, ὅτε ἄδηλον ἔχοντα τὰ στρατεύματα⁶ τὴν κρίσιν τοῦ πολέμου διατετάρακται⁷ τῷ φόβῳ, δυνηθεῖς πη λαβεῖν αἰχμαλώτους ὁ στρατηγὸς⁸ ἢ ἀπὸ ἐνέδρας ἢ διακροβολισάμενος⁹ ἢ καὶ ἀποστατοῦντας τῆς ἰδίας παρεμβολῆς, εἰ μὲν τινας γενναίους¹⁰ τοῖς φρονήμασι καὶ τοῖς σώμασι καταμάθοι, τούτους ἢ ἀποκτεινάτω παραχρῆμα λαβὼν ἢ δήσας παραδότη τῶν ἐπὶ ταῦτα τεταγμένοις φυλάττειν κελεύσας,¹¹ ὅπως μὴ πολλοὶ θεάσωνται τοὺς ἄνδρας, εἰ δὲ ἀσθενεῖς καὶ ἀγεννεῖς¹² καὶ μικροψύχους, ἔτι καὶ προαπειλήσας¹³ σφίσιν ἐπὶ τῆς ἰδίας σκηνῆς καὶ προδουλώσας¹⁴ σφῶν¹⁵ τῷ φόβῳ¹⁶ τὰς ψυχὰς εἰς τὰ πλήθη προαγέτω¹⁷ δακρύνοντας καὶ δεομένους, ἅμα λέγων καὶ ἐνδεικνύμενος¹⁸ τοῖς στρα-

¹ γὰρ vGH.

² ὥστε μηδὲν ἐθέλειν τολμᾶν καὶ οὕτως καταφρονεῖν om. R.

³ δεῖ τὰ ταπεινὰ vGH (δεῖ τὰ ταπεινὰ G).

⁴ Köchly: ποτ' αὖ F: πότε ἂν τὰ vGH.

⁵ Title om. F (but a break is indicated) GH (both without any break); probably composed by Koraes, since Rigaltius and Schwebel print merely the Latin caption "Militum animos ex captivorum adspectu excitari posse."

⁶ ἔχον τὸ στράτευμα vGH.

THE GENERAL, xiv. 2 – 3

These two misfortunes happen to armies, to become so terrified of the enemy that they are unwilling to attempt any offensive, and so bold that they are unwilling to take any precautionary measures. With regard to each the general must arrange his plans, and know when by voice and look he must make the enemy appear weak, and when more threatening and formidable.

(2) [*Encouraging the frightened Army*]

On the eve of battle, when the army, uncertain of the outcome of the war, is distrustful and fearful, the general, if he is able, should manage to capture some prisoners by ambush or skirmishing, or some men who have strayed from their own camp. If he learns that they are strong in courage and in body, he should either kill them on the spot or turn them over, securely bound, to men assigned to this duty, with orders to guard them, so that not many of his own forces may see them; but if they are weak and cowardly and spiritless, after threatening them in the privacy of his own tent and enslaving their minds through fear, he should lead them, weeping and supplicating, before his army, pointing out to

⁷ FDGH: διαπέπρακται “omnes codd.” (Schwebel, meaning probably EN and the mss. of Rigaltius [except M]).

⁸ εἰ δυνήθη (δυνήθη GH, -θεί A m²) ἐφόδῳ λαβεῖν ὁ στρατηγὸς αἰχμαλώτοις vGH. ⁹ δι’ ἀκροβολισάμενος F.

¹⁰ FRGH: γενναίους Rigaltius “ceteri codd. ut vid.”

¹¹ FGH: κελεύσας φυλάττειν v.

¹² ἀγενεῖς PGHv(?). ¹³ προ//////////λήσας G (lacuna).

¹⁴ σφίσι . . . προδουλώσας om. R.

¹⁵ προδουλω//////////ῶν G (lacuna). ¹⁶ τοῦ φόβου F.

¹⁷ προσαγέτω vGH. ¹⁸ FGH: δεικνύμενος vGH.

ONASANDER

τιώταις, ὡς ἀγενεῖς¹ καὶ ταπεινοὶ καὶ οὐδενὸς ἄξιοι, καὶ ὡς πρὸς τοιούτους ἐστὶν ἄνδρας² αὐτοῖς ἢ μάχῃ δεδιότας οὕτως τὸν θάνατον, ἀπτομέ- νους γονάτων καὶ προκυλιομένους τῶν ἐκάστου
 4 ποδῶν. ἐπαναθαρρεῖ γὰρ ἐπὶ τούτοις ὁ στρατὸς ἤδη προκατανενοηκῶς τῶν πολεμίων ὄψεις τε καὶ πάθη ψυχῆς· αἰεὶ³ γάρ, ὃ μηδέπω τις ἐώρακεν, ἐλπίζει⁴ μείζον γενήσεσθαι⁵ τῆς ἀληθείας,⁶ ἔτι καὶ τῷ τοῦ μέλλοντος φόβῳ τὴν ἐλπίδα μετρεῖ πρὸς τὸ χαλεπώτερον.

XV. [Ὅτι διαφοραὶ πολλαὶ τῶν τάξεων]⁷

Τάξις δ' οὐ μία πολέμου,⁸ πολλὰ δὲ καὶ διά- φοροι καὶ παρὰ τοὺς ὀπλισμοὺς καὶ παρὰ τοὺς στρατευομένους⁹ καὶ παρὰ τοὺς τόπους καὶ παρὰ τοὺς ἀντιπολέμους,¹⁰ ὧν τὰς διαφορὰς ὁ στρατηγὸς ἐπ' αὐτῶν εἴσεται τῶν καιρῶν¹¹· ἃ δ' ἂν οὐχ¹² ἦκιστα πολλαῖς ἀρμόζοι¹³ παρατάξεισι δίχα τῶν ἐπ' αὐτῶν τῶν πραγμάτων ἀνάγκην ἐχουσῶν νοεῖσθαι, ταῦθ' ὡς ἐν κεφαλαίῳ δίδειμι.

XVI. [Ὅτι πρὸς τὸ ἀντιπόμενον καὶ τὸ ἴδιον συντάξει]¹⁴

Ἴππεῖς μὲν δὴ στρατηγὸς οὐχ οὕτως, ὡς βού- λεται, μᾶλλον δ' ὡς ἀναγκάζεται, τάξει· πρὸς

¹ ἀγενεῖς PGH.

² ἄνδρας ἐστὶν Rigaltius Schwebel Koraes.

³ εἰ vGHKPA m².

⁴ ἐλπίζειν K.

⁵ Köchly (note): γίγνεσθαι (text): γενέσθαι Koraes: γίνεται vGH: γε F. Perhaps γεγενῆσθαι.

⁶ Schwebel: ταῖς ἀληθείαις Ω.

⁷ Title om. F and no break indicated: in margin GH.

THE GENERAL, XIV. 3 - XVI. 1

his soldiers how base and wretched and worthless they are, and saying that it is against such men that they are to fight, men who are so greatly afraid of death, who cling to the knees and grovel at the feet of every one. The army is emboldened at all this, since they know before the conflict the appearance of the enemy and his state of mind. For what a man has never seen he always expects will be greater than it really is ; so also because of his fear of the future, a man measures his apprehensions by reference to the more grievous outcome.

XV. [*The Difference in Battle Formations*]

Battle formation is not of one but of many and various kinds, with regard to arms and soldiers and terrain and enemies. These differences the general will have to know on the occasions themselves, but what pertains in large part to many formations I shall briefly summarize, without considering the details which, in the actions themselves, must necessarily be understood.

XVI. [*Battle Formation with regard to that of the Enemy*]

The general will arrange his cavalry not as he wishes but rather as he is compelled ; for he will

⁸ FC Leo, *Tactica*, xx. 182: om. vPGH Saguntinus Camerarius.

⁹ F Leo (*l.c.*): στρατευσαμένων vGH.

¹⁰ ἀντιπολεμίους vGH.

¹¹ FCD: αὐτὸν . . . τὸν καιρὸν vGH.

¹² FGH: ἃ δ' οὐχ v.

¹³ ἀρμόζει vGH.

¹⁴ Title om. F: in margin GH: συντάξει. Korais: συντάσσει
GH Rigaltius Schwebel.

ONASANDER

γὰρ τὸ ἀντιπόλεμον ἵππικὸν καὶ τὸ ἴδιον στήσει. ταττέτω δ' ὡς τὰ πολλὰ κατὰ τὰς ἐκ παρατάξεως μάχας ἐπὶ κέρως,¹ ἵνα καὶ² κατὰ πρόσωπον καὶ ἐκ πλαγίων προσβάλλοντες³ καὶ τόπῳ μείζονι χρώμενοι, μεθ' οὓς⁴ οὐκ ἔτ' ἄλλοι τεταγμένοι τυγχάνουσιν, ἔχωσιν ἀποχρῆσθαι τῇ τῆς ἵππικῆς ἐπιστήμῃ.

XVII. [Ἔστι τὸς ψιλὸς ἀκοντιστὰς καὶ τοξότας καὶ σφενδονιστὰς⁵ πρώτους στήσει τῆς φάλαγγος]⁶

Ψιλὸς δέ, ἀκοντιστὰς καὶ τοξότας⁷ καὶ σφενδονήτας,⁸ πρώτους πρὸ τῆς φάλαγγος τάξει⁹ κατόπιν μὲν γὰρ ὄντες πλείονα κακὰ διαθήσουσι τοὺς ἰδίους ἢ τοὺς πολεμίους, ἐν μέσοις δ' αὐτοῖς ἄπρακτον ἔξουσι τὴν ἰδίαν ἐμπειρίαν, οὐθ' ὑποχωρεῖν ἀνὰ πόδα δυνάμενοι κατὰ τὴν ἀνάτασιν¹⁰ τῶν ἀκοντίων, οὐτ' ἐξ ἐπιδρομῆς βαλεῖν¹¹ προηγουμένων ἄλλων καὶ παρὰ ποσὶν ὄντων, οὐδέ μῆν¹² οἱ σφενδονῆται κυκλόσε τὸν δῖνον¹³ ἀποτελεῖν τῆς σφενδόνης παρὰ πλευρὰν ἐστῶτων¹⁴ φιλιῶν¹⁵ ὀπλιτῶν καὶ πρὸς τὸν ῥόμβον ἀντιπταιόντων,¹⁶ οἳ τε τοξόται προΐοντες μὲν τῶν ἄλλων εἰς αὐτὰ τὰ σώματα καὶ κατὰ σκοπὸν ἐκτοξεύουσι τὰ βέλη,¹⁷ μετὰ δὲ τοὺς λόχους ἢ ἐν αὐτοῖς μέσοις¹⁸

¹ ἐκ παρατάξεως . . . ἐπικέρως F.

² κατὰ τὰς . . . ἵνα καὶ om. R and Camerarius.

³ προσβάλλοντες v (?)GH.

⁴ Om. H.

⁵ The ending is too much abbreviated in GH to tell which form is used. See below, § 1.

⁶ Title om. F: in margin GH.

⁷ καὶ τοξότας om. F.

⁸ F (without accent) R: σφενδονιστὰς vGH.

THE GENERAL, XVI. 1 – XVII. 1

oppose his own cavalry to that of the enemy. As a rule, in pitched battles he should arrange his cavalry in column formation, in order that attacking both in front and on the flanks and covering a greater amount of space (if no other soldiers are drawn up in their rear), they may thus be able to make use of their skill in cavalry fighting.

XVII. [*Placing the light-armed Troops, Javelin-throwers, Bowmen and Slingers, before the Phalanx*]

The general will assign his light-armed troops—javelin-throwers, bowmen, and slingers—to a position in front of the phalanx, for if placed in the rear they will do more damage to their own army than to the enemy, and if in among the heavy-armed, their peculiar skill will be ineffectual because they will be unable to take a step backwards in throwing their javelins or to charge forward and cast them, as other soldiers are in front of them and at their heels, nor will the slingers be able to execute the whirling of their slings, as their fellow-soldiers stand at their side and, in their turn, are caused to stumble in trying to avoid the whirling slings. If the bowmen are placed in front of the army, they will shoot their arrows at the enemy as at a target; but drawn up behind the ranks or in among the

⁹ FC: στήσει vGH.

¹⁰ ἀνάστασιν F.

¹¹ βάλλειν vGH Kōchly.

¹² μὲν vGH.

¹³ Kōchly: σφενδονηται κυκλοσε τον δεινον F: σφενδονηται (σφενδονιται GH) κύκλους τῶν λίνων vGH.

¹⁴ παραπλευραν ἔστω τῶν F.

¹⁵ χιλίων R.

¹⁶ Kōchly: ἀντιπαιόντων F: ἀντιπιπτότων vGH.

¹⁷ F indicates a break at this point.

¹⁸ FPGH: τοῖς μέσοις vGH.

ONASANDER

ὄντες εἰς ὕψος¹ τοξεύουσιν,² ὥστε πρὸς μὲν τὴν ἄνω φορὰν τόνον ἔχειν τὸ βέλος, αὐθις δέ, κἂν κατὰ κεφαλῆς πίπτῃ τῶν πολεμίων, ἐκλελύσθαι καὶ μὴ πάνυ τι³ λυπεῖν τοὺς ἐχθρούς.

XVIII. [Περὶ τοῦ ἐν τοῖς τραχέσι τόποις τάττειν τοὺς ψιλοὺς]⁴

Εἰ δὲ συμβαίνοι⁵ γίνεσθαι⁶ τὴν μάχην ἐν χωρίοις τινὰς μὲν χθαμαλοὺς τινὰς δὲ βουνοειδεῖς ἔχουσι τόπους, τότε δὴ μάλιστα τοὺς ψιλοὺς ἐν τοῖς τραχέσιν ταττέτω, καὶ δὴ, κἂν⁷ αὐτὸς τὰ πεδινὰ κατειλημμένος ἦ, τῶν δὲ πολεμίων μέρη τινὰ τῆς φάλαγγος ὀχθώδεις⁸ διακατέχῃ⁹ τόπους, κατὰ τούτους ἐπαγέτω¹⁰ τοὺς ψιλοὺς· ῥᾶόν τε γὰρ βαλόντες¹¹ ὑποχωροῦσιν ἀπὸ τῶν τραχέων, ῥᾶστά τε τοῖς ἀνάντεσιν ἐπαναθέουσιν, ἂν¹² ἐλαφροὶ τυγχάνωσιν.¹³

XIX. [Περὶ τοῦ χωρία ἔχειν τὰς παρατάξεις δι' ὧν ὀφειλοῦσιν οἱ ψιλοὶ ἐντὸς τῶν κοντῶν¹⁴ εἰσερχόμενοι ὑποστέλλεσθαι]⁴

Ἔστω δὲ διαστήματα¹⁵ κατὰ τὰς τάξεις,¹⁶ ἵν', ἐπειδὰν ἐκκενώσωσιν¹⁷ ἔτι προαγόντων¹⁸ τῶν πολεμίων τὰ βέλη, πρὶν εἰς χεῖρας ἐλθεῖν τὰς φάλαγ-

¹ ὕψους R.

² τοξεύουσιν F.

³ FC: πάντη ENPGH Rigaltius "alii codd. ut vid." (but om. καί).

⁴ Title om. F: in margin GH.

⁵ συμβαίνει vGH Kschly.

⁶ FGH: γίνεσθαι v.

⁷ καὶ RA m².

⁸ FGH: ὀχθώδη Pv.

⁹ διακατέχει vGH.

¹⁰ ἀπαγέτω GH Rigaltius "ceteri codd. ut vid."

heavy-armed they will shoot high, so that the arrows have impetus only for their upward flight, and afterwards, even if they fall on the heads of the enemy, will have spent their force and cause little distress to the foe.

XVIII. [*Disposition of light-armed Troops in a broken Country*]

If the battle should happen to be in a country that is level in some places but hilly in others, then the light-armed troops should by all means be stationed in the uneven section, and then, if the general himself should have seized the plain and some part of the enemy's phalanx should possess the heights, he should send against them the light-armed troops; for from the uneven ground they can more easily hurl their weapons and retreat, or they can very easily charge up the slopes, if they are agile.

XIX. [*The Phalanx should leave Intervals for the light-armed Troops to retire through the Ranks*]

There should be intervals within the ranks, so that, when the light-armed troops have discharged their weapons while the enemy is still advancing, before the

¹¹ βάλλοντες vGH.

¹² Om. F.

¹³ FEN: τυγχάνουσιν GH.

¹⁴ κον^{ττ} GH (probably κοντῶν): κτόν VM (a copy of G); άκοντίων K (and others - Koracs). ¹⁵ διάστημα vGH.

¹⁶ FCGH: πράξεις PD: παρατάξεις Koracs.

¹⁷ FGH: έκκενώσας P ("codd. reliqui omnes" Schwebel).

¹⁸ προαγαγόντων vGH.

ONASANDER

γας, ἐπιστρέψαντες ἐν κόσμῳ διεξίωσιν¹ μέσσην τὴν φάλαγγα καὶ ἀταράχως ἐπὶ τὴν οὐραγίαν ἀποκομισθῶσιν· οὔτε γὰρ κυκλεύειν αὐτοὺς ἅπαν τὸ στράτευμα καὶ κάμπτειν² κατὰ κέρας ἀσφαλές ἐστι³ — τάχα γὰρ που φθάσουσιν⁴ αὐτοὺς ἐν τούτῳ συμμίζαντες οἱ πολέμιοι καὶ μέσους ἀπολαβόντες —, οὔτε διὰ τῶν πεπυκνωμένων βιάζεσθαι, καὶ εἰς τὰ ὄπλα ἐμπίπτοντας τάραχον ἐμποιεῖν ταῖς τάξεσιν ἄλλου πρὸς ἄλλον ἐνσεϊόντος.

2 αἱ δὲ κατὰ κέρας ἔφοδοι τῶν ψιλῶν πλείονα λυμαίνονται τοὺς πολεμίους, ἐκ πλαγίων ἀκοντιζόντων καὶ εἰς τὰ γυμνὰ παραβιαζομένων⁵ παίειν.

3 ἢ δὲ τῆς σφενδόνης ἄμυνα χαλεπωτάτη τῶν ἐν τοῖς ψιλοῖς ἐστίν· ὁ τε γὰρ μόλιβδος ὁμόχρους ὦν τῷ ἀέρι λανθάνει φερόμενος, ὥστ' ἀπροοράτως ἀφυλάκτοις⁶ τοῖς τῶν πολεμίων ἐμπίπτειν⁷ σώμασιν, αὐτῆς τε⁸ τῆς ἐμπτώσεως σφοδρᾶς οὔσης καὶ ὑπὸ τοῦ ροίζου⁹ τριβόμενον τῷ ἀέρι¹⁰ τὸ¹¹ βέλος ἐκπυρωθὲν ὡς βαθυτάτῳ δύεται τῆς σαρκός, ὥστε μηδ' ὀράσθαι, ταχὺ δὲ καὶ τὸν ὄγκον ἐπιμύειν.

XX. [Ὅπως δεῖ, ἐὰν ἀπορῇ ψιλῆς συμμαχίας ὁ στρατηγός, οἱ δὲ πολέμιοι εὐπορῶσιν, ἐπιφέρεσθαι αὐτοῖς¹²]

Εἰ δὲ αὐτὸς μὲν ἐνδεὴς εἴη τῆς τῶν ψιλῶν συμμαχίας, οἱ δὲ¹³ πολέμιοι ταύτῃ¹⁴ πλεονεκτοῖεν,

¹ δεῖξωσιν GH: δεῖξωσι v: διεξίωσι Köchly: διήξωσι Korraes.

² κατακάμπτειν vGH.

³ ἐστίν Köchly.

⁴ φθάσωσιν vGH.

⁵ παραβιαζομένειν P and "quidam mss." (Schwebel).

⁶ FCGH: ἀφυλάκτως ἀπροοράτως P Rigaltius A m²: ἀφυλάκτως καὶ ἀπροοράτως EN.

⁷ FC: ἐμπίπτει PGHA m².

two armies come to close quarters, they may about-face, pass in good order through the centre of the phalanx, and come without confusion to the rear. For it is not safe for them to go around the whole army, encircling the flanks—since the enemy would quickly anticipate them in this manœuvre, coming to close quarters and intercepting them on the way—nor is it safe for them to force their way through the closed ranks, where they would fall over the weapons and cause confusion in the lines, one man stumbling against another. Attacks of the light-armed troops on the flanks cause the enemy greater loss, since they cast their javelins from the side and of necessity strike the body where unprotected. The sling is the most deadly weapon that is used by the light-armed troops, because the lead slug is the same colour as the air and is invisible in its course, so that it falls unexpectedly on the unprotected bodies of the enemy, and not only is the impact itself violent, but also the missile, heated by the friction of its rush through the air,¹ penetrates the flesh very deeply, so that it even becomes invisible and the swelling quickly closes over it.

XX. [*How to attack, without light-armed Troops, an Enemy who has many*]

If the general himself should lack an auxiliary force of light-armed troops while the enemy has a

¹ For other testimony as to the heating of the lead *glans* by the rapidity of its flight through the air see Lucretius vi. 306 f. ; Ovid, *Metam.* ii. 727 ff. ; xiv. 825.

⁸ δὲ GH.

¹¹ Om. PGH.

¹³ μὲν F.

⁹ ῥύξου GH.

¹² Title om. F : in margin GH.

¹⁰ ἐν τῷ ἀέρι vGH.

¹⁴ ταύτην vGH.

ONASANDER

οἱ μὲν¹ πρωτοστάται πυκνοὶ πορευέσθων² ἔχοντες ἀνδρομήκεις³ θυρεοὺς, ὥστε σκέπειν ὅλα τὰ σώματα τοῖς μήκεσιν,⁴ οἱ δὲ μετὰ τούτους καὶ οἱ κατόπιν τούτων ἄχρι τῶν τελευταίων ὑπὲρ⁵ κεφαλῆς ἀράμενοι τοὺς θυρεοὺς τέως ἐχόντων, ἄχρι ἂν ἐντὸς γένωνται⁶ βέλους· οὕτως γάρ, ὡς εἰπεῖν,⁷ κεραμωθέντες οὐθὲν πείσονται⁸ 2 δεινὸν ὑπὸ τῶν ἐκηβόλων. εἰ δὲ παρ' ἑκατέρους ἢ τῶν ψιλῶν εἶη βοήθεια, πρῶτοι πρὸ τῆς ἐκ χειρὸς μάχης⁹ ἀκροβολιζέσθων¹⁰ τοῖς ἀντιπάλοις, ἢ μετὰ τὴν συμπλοκὴν τῆς φάλαγγος ἐκ πλαγίων ἐπιθέοντες¹¹ ἀποχρήσθων¹² τοῖς βέλεσιν· συνελαύνονται¹³ γὰρ εἰς ὀλίγον καὶ οὐχ ἤττον θορυβοῦνται τοῖς τοιούτοις ἀμυντηρίοις.

XXI. [Περὶ τοῦ μὴ εἰς πολὺ μῆκος ἐκτείνειν τὴν φάλαγγα τὰς κυκλώσεις τῶν ἐναντίων φοβουμένου¹⁴]

Τὰς δὲ κυκλώσεις φυλάττεσθαι βουλόμενος μῆθ' οὕτως ἐπὶ μῆκος ἐκτεινέτω¹⁵ τὴν δύναμιν, ὥστε πάμπαν ἀσθενῆ καὶ ἀβαθῆ ποιῆσαι τὴν φάλαγγα —ταχὺ γάρ που συμβαίνει τοὺς πολεμίους διαρρήξαντας αὐτὴν δίοδον ποιεῖσθαι, καὶ μηκέτι παρὰ κέρας ἐνεργεῖν ταῖς κυκλώσεσιν, ἀλλὰ διεκπεσόντας¹⁶ μέσους κατὰ νώτου γίγνεσθαι τῶν

¹ δὲ F.

² πορευέσθωσαν vGH.

³ Kœchly: ἐπιμήκεις Ω.

⁴ Kœchly: ἀνδρομήκεσιν Ω.

⁵ ἐπὶ RA m².

⁶ γίνωνται F.

⁷ FC: ὡς εἶπον GH: εἶπον P (om. ὡς).

⁸ πῆσονται R.

⁹ μάχης H.

¹⁰ ἀκροβολιζέσθωσαν vGH.

¹¹ FGH: ἐπιθέοντες v.

¹² ἀποχρίσθωσαν vGII.

THE GENERAL, xx. 1 - xxi. 1

large force of them, the front rank men should advance in close formation, with shields the height of a man, tall enough to protect the whole body, and those who follow and the ones behind them, even to the last rank, should carry their shields above their heads, while they are within bowshot of the enemy. For thus roofed in, so to speak, they will suffer no danger from missiles. But if each army should have a number of light-armed troops, the general should order his own light-armed men to be the first to hurl their weapons against their opponents before the hand-to-hand battle; or after the clash of the phalanx, attacking from the flank, they should make use of their missiles, for thus the enemy will be forced together into a narrow space and will be greatly confused by such tactics.

XXI. [*The Needlessness of Lengthening the Phalanx in Fear of an encircling Movement of the Enemy*]

The general who wishes to guard against an encircling movement of the enemy should not so extend his forces lengthwise as utterly to weaken the phalanx by giving it no depth. For this would result in the enemy somewhere quickly breaking through; and no longer attempting an encircling movement on the flank, but piercing the centre instead, they would take their opponents in the

¹³ συναλεύονται P Rigaltius and "quidam libri" (Schwebel).

¹⁴ Rigaltius Köchly: φοβουμένοις A: φοβοίμενος Schwebel: φοβούμενον Koraes. Title om. F: in margin GH.

¹⁵ ἐκτεινάτω ἐπὶ μῆκος A m².

¹⁶ διαπεσόντας A m².

ONASANDER

ἐναντίων· τὸ δὲ¹ αὐτὸ μὴ μόνον φυλαττέσθω παθεῖν, ἀλλὰ καὶ ζητεῖτω ποιεῖν, ἔὰν ἀσθενῇ καὶ λεπτήν κατανοήσῃ τὴν τῶν πολεμίων² φάλαγγα—, μὴθ' οὕτως ἐπ' οὐρὰν συστελλέτω³ τὴν παράταξιν εἰς πολὺ βάθος ὑποστέλλων,⁴ ὥστ' ἐκ τοῦ ῥάστου τοὺς πολεμίους ὑπερκεράσαντας ἐντὸς αὐτὴν λα-
2 βεῖν. ἰσχυροποιεῖτω μέντοι⁵ γε τὴν οὐραγίαν καὶ τοὺς παρὰ πλευρὰν τῶν κεράτων μὴ ἔλαττον τῶν πρωτοστατῶν· οὐχ ἤττον γὰρ⁶ ἀποκωλύουσιν οἱ κατ' οὐρὰν τὰς κυκλώσεις τῶν ἐπὶ κέρας ἐκτεινομένων, ἔὰν ἤτοι⁷ φθάσας ὁ στρατηγὸς τὸ μέλλον ἀπλώσας τὴν οὐραγίαν καὶ παρὰ τὰ κέρατα⁸ τῆς φάλαγγος ἀναβιβάσας⁹ ἑκατέρωθεν παραστήσῃ τοὺς κατόπιον εἰς τὸ πρόσωπον τῶν πολεμίων, ἢ καὶ παραγγείλῃ τοῖς ἐφθασμένοις ἤδη κυκλωθῆναι τὰ νῶτα τοῖς τῶν προηγουμένων νώτοις ἐγκλίνοντας¹⁰ ἀμφίστομον ποιεῖσθαι τὴν μάχην.

3 Ἀγχίνους μὲν στρατηγὸς τις πολλοὺς ὄρων τοὺς πολεμίους¹¹ αὐτὸς ἐλάττοσι¹² στρατιώταις μέλλων¹³ κινδυνεύειν ἐξελέξατο καὶ ἐπετήδευσε τοιούτων ἐπιτυχεῖν τόπων, ἐν οἷς ἢ¹⁴ παρὰ ποταμίαν ὄφρὺν ταξάμενος ἀπωθεῖται¹⁵ ταύτῃ τὴν κύκλωσιν τῶν πολεμίων, ἢ παρῶρειαν ἐκλεξάμενος¹⁶ αὐτοῖς τοῖς ὄρεσιν ἀποκλείσει τοὺς ὑπερκεράσαι¹⁷ βουλομένους, ὀλίγους ἐπιστήσας ἐπὶ τῶν

¹ τοῦτο δ' Koraes.

² Koraes and Köchly independently and so the tr. of Camerarius: πεδίων F: πεζῶν vGH.

³ συστελέτω GH.

⁴ Köchly: ἀποστέλλων Ω.

⁵ Köchly: μὲν γὰρ Ω.

⁶ ἤττον μὲν γὰρ vGH.

⁷ ἤδη vGH.

⁸ Köchly: τὰ παρὰ vH: τὰ παρακέρατα G.

⁹ καὶ παρὰ . . . ἀναβιβάσας om. F.

rear; and this very manœuvre the general should not only guard against but also strive to execute if he discovers that the enemy's phalanx is weak and thin. Nor should he contract his phalanx, drawing it out toward the rear to great depth to such an extent that the enemy would easily outflank and surround it. But he should make his rear and the flanks of the wings as strong as the front ranks. For those in the rear will prevent the phalanx being encircled no less than those who are posted so as to extend the flanks, if the general, anticipating what is to happen, spreads out his rear guard and posting it on either flank of the phalanx opposes his rear to the front of the enemy, or if he commands those who are already encircled to turn their backs to the backs of the front ranks and fight on a double front

A shrewd general who sees that the enemy has many troops when he himself is about to engage with fewer, will select, or rather make it his practice to find, localities where he may prevent an encircling movement of the enemy, either by arranging his army along the bank of a river, or, by choosing a mountainous district, he will use the mountains themselves to block off those who wish to outflank him, placing a few men on the summits to prevent

¹⁰ ἐγκλιναντας Koraes Köchly (but the latter probably through a misprint; compare his note).

¹¹ Köchly: μὲν γὰρ ὅστις πολλοὺς ὀρῶν τ. π. FCv (ὀρων F); μὲν γὰρ ὅστις ὀρῶν τοὺς πολεμικοὺς πολλοὺς GH.

¹² ἐλάττωσιν F.

¹³ μέλλον GH.

¹⁴ ὁ R.

¹⁵ Rigaltius (in a note correcting C) Koraes Köchly: ἀποτελείται FC; ἀποθείται Schwebel (probably a misprint); om. P Rigaltius GH (Köchly's apparatus is partly in error).

¹⁶ ἀπωθείται . . . ἐκλεξάμενος om. P Rigaltius GH.

¹⁷ CENA m^a: ὑπὲρ κέρας F; ὑπερκεράστας PGH.

ONASANDER

ὑψηλῶν τοὺς ἀποκωλύσοντας¹ ὑπὲρ κεφαλὴν
 4 ἀναβάντας γίγνεσθαι τοὺς πολεμίους. οὐ μὴν
 ἢ στρατηγικὴ φρόνησις ἐνταῦθα συλλαμβάνεται
 μόνον, ἀλλὰ καὶ ἡ τύχη· δεῖ γὰρ ἐπιτυχεῖν τοιού-
 των χωρίων· οὐ γὰρ αὐτῶ² γε κατασκευάσασθαι
 δυνατὸν τοὺς³ τόπους· τῶν ὄντων μέντοι τοὺς
 ἀμείνους ἐκλέξασθαι καὶ τοὺς συνοίσοντας ἐνοῆσαι
 φρονίμου.

5 Πολλάκις δὲ⁴ εἰώθασιν οἱ⁵ μεγάλη δυνάμει καὶ
 πολυάνδρῳ κεκρημένοι μνηοειδῆς σχῆμα ποιή-
 σαντες τῆς παρατάξεως ἐπιέναι, νομίζοντες ὅτι
 προσάγονται⁶ τοὺς πολεμίους καὶ κατ' ἄνδρα⁷
 βουλομένους⁸ συνάπτειν, εἶτα κατὰ τὸ ἡμικύκλιον
 εἰς ὁδὸν κυρτουμένους ἐναπολήφονται τῷ περι-
 έχοντι κόλπῳ,⁹ τὰς ἰδίας κεραίας ἐπισυνάπτοντες
 6 ἀλλήλαις¹⁰ εἰς κύκλου σχῆμα. πρὸς οὓς ἀντεπακ-
 τέον¹¹ οὐχ ᾧδε· τριχῆ δὲ διελὼν τὴν ἰδίαν δύνα-
 μιν τῶν¹² μὲν δυεῖν¹³ ἑκατέρῳ μέρει κατὰ κέρας
 προσβαλλέτω¹⁴ τοῖς πολεμίοις, τῷ¹⁵ δὲ ἐνί, τοῖς
 εἰς τὸν μέσον κόλπον τοῦ μνηοειδοῦς ἀντι-
 παρατεταγμένοις,¹⁶ ἐναντίος¹⁷ ἐστάτω¹⁸ καὶ μὴ
 προαγέτω· ἢ¹⁹ γὰρ μένοντες ἐπὶ τοῦ κυκλοειδοῦς
 σχήματος οἱ κατὰ μέσσην τὴν²⁰ φάλαγγα τεταγμένοι
 τῶν ἐχθρῶν ἄπρακτοι μηδὲν²¹ δρῶντες ἐστήξον-
 ται, ἢ προϊόντες εἰς τοῦμπροσθεν, εἰ βούλουτο
 προάγειν φάλαγγηδὸν εἰς εὐθειᾶν ἐκ τοῦ σιγματο-

¹ ἀποκωλύσαντας PA m².

² Kschly: αὐτῶ F: αὐτῷ CEN: αὐτό PGH and "alii."

³ Om. F. ⁴ γὰρ KA m². ⁵ οἱ γε vGH.

⁶ FPGH: προσάξονται v. ⁷ FC: κατὰ ἄνδρας vPGH.

⁸ βουλομένοις vPGH: βουλόμενοι Korae: αὐτοὺς should be added, suggests Kschly.

⁹ FGH: κύκλῳ PnA m².

¹⁰ ἀλλήλοισ vGH.

THE GENERAL, XXI. 3 - 6

the enemy from climbing above the heads of the main army. Not alone does knowledge of military science play a part in this matter but luck as well; for it is necessary to have the luck to find such places; one cannot prepare the terrain for oneself. To choose the better positions, however, from those at hand, and to know which will be advantageous, is the part of the wise general.

It is often the custom of generals who are in command of a powerful and numerous army to march to battle in a crescent formation, believing that their opponents also wish the battle to come to close quarters, and that they will thus induce them to fight; then, as their opponents are bent back into the road at the points of the crescent, they will intercept them with their enveloping folds, joining the extremes of their own wings to form a complete circle. Against troops advancing in this fashion, one should not likewise adopt the crescent formation, but dividing his own army into three parts. the general should send two against the enemy, one against each wing, but the third division, that which faces the central hollow of the crescent, should stand still, opposite the enemy, and not advance. For if the enemy maintain this crescent formation, those drawn up in the centre of their army will be useless, standing still and doing nothing; but if marching forward they wish to advance in a body,

¹¹ αἰτούς τακτέον R: ἀντιτακτέον vGH.

¹² τοῖν vGH: τοῖς PA m².

¹³ δυοῖν ENR: διοείν GH.

¹⁴ προβαλλέτω F.

¹⁵ τὸ R.

¹⁶ ἀντιπαρατεταγμένος F (corr. B): ἀντιπαραταπτομένοις vGH.

¹⁷ ἐναντίως vGH.

¹⁸ ἰστάτω R.

¹⁹ οἱ F.

²⁰ Om. vGH.

²¹ καὶ μηδὲν Koraes.

ONASANDER

ειδοῦς ἀπλούμενοι σχήματος, ἀλλήλους ἐκθλίψουσι¹
 καὶ λύσουσι τὴν τάξιν² — τῶν γὰρ ἐπὶ κέρως³ ἐπὶ
 τῆς αὐτῆς μενόντων χώρας⁴ καὶ μαχομένων οὐχ
 οἶόν τε τὸ ἡμικύκλιον εἰς εὐθείαν ἀνελθεῖν⁵ —
 ἔνθα δὴ τεταραγμένων αὐτῶν καὶ λευκότων
 τὴν τάξιν τῷ τρίτῳ τάγματι⁶ καὶ ἐφέδρω⁷
 προσβαλλέτω⁸ τοῖς ἀπὸ τοῦ μέσου κυρτώματος
 7 προάγουσιν⁹ ἀτάκτως εἰς τοῦμπροσθεν. εἰάν
 δὲ διαμένωσιν¹⁰ ἐπὶ τοῦ κοίλου σχήματος, τοὺς
 ψιλοὺς καὶ ἐκηβόλους ἔνθα¹¹ κατ' ἀντικρὺ ταπτέτω·
 8 βάλλοντες γὰρ αὐτοὺς πολλὰ λυπήσουσιν. οὐ
 μὴν ἀλλὰ καὶ εἰ¹² λοξῇ πάσῃ τῇ ἰδίᾳ φάλαγγι
 προσβίλλει¹³ κατὰ θάτερον κέρας¹⁴ τῶν πολεμίων,
 οὐκ ἂν ἀμάρτοι πρὸς τὴν ἐκ τοῦ μηνοειδοῦς σχή-
 ματος κύκλωσιν οὕτως ἀντεπιών· ἐπὶ πολὺ¹⁵ γὰρ
 οἱ ἐξ ἐναντίας εἰς χεῖρας ἰέναι πανστρατιᾶ κω-
 λυόμενοι κατ' ὀλίγους κερασθήσονται, τῶν ἐπὶ
 θατέρου κέρως¹⁶ μόνων μαχομένων, οἳ καὶ πρῶτοι
 κατ' ἀνάγκην συμμίζουσι διὰ τὴν λοξὴν ἔφοδον.
 9 Οὐκ ἄχρηστον δέ ποτε καὶ ἀντιπαραταξάμενον
 ὑπὸ πόδα τῷ στρατεύματι χωρεῖν, ὡς κατα-
 πεπληγμένον,¹⁷ ἢ καὶ ἐπιστρέψαντα παραπλησίαν
 φυγῇ ποιεῖσθαι τὴν ἐπιχώρησιν¹⁸ ἐν τάξει, εἴτ'
 αὖθις μεταβαλόμενον¹⁹ ἀντεπιέναι τοῖς ἐπιούσιν·
 ἐνίστε²⁰ γὰρ ὑπὸ χαρᾶς οἱ πολέμοιοι δόξαντες

¹ ἐκθλίψουσιν GH.

² F marks a break here.

³ Schwebel: ἐπὶ κέρας Ω (ἐπικέρας FGH). ⁴ χορείας F.

⁵ Köchly: ἐλθεῖν Ω (ἐλθειν F). ⁶ πράγματι A m².

⁷ ἐφόδῳ ENR (marg.): ἐφόδρω A m².

⁸ FC: περιβαλλέτω vPGH.

⁹ προσάγουσιν GH Rigaltius "alii codd."

¹⁰ Koraeas: δὲ δὴ μένωσιν F: δὲ δὴ μένουσιν vPGH.

¹¹ ἐνταῦθα vGH.

¹² Om. F.

THE GENERAL, xxi. 6 – 9

changing from the crescent formation to a straight line, they will be crowded together and will lose their formation—for while the wings are remaining in the same position and fighting, it is impossible for a crescent to return to a straight line. Then when they are confused and their ranks disordered, the opposing general should send the third and reserve division against the men advancing in disorder from the centre of the curve. But if the enemy remain in the crescent position, the general should post his light-armed troops and archers opposite them, who with their missiles will cause heavy loss. However, if he advances with his whole phalanx obliquely against one wing of the enemy, he will make no mistake in attacking in this manner, as far as the encircling movement of the crescent formation is concerned; for the enemy will be prevented for a long time from coming to close quarters with their whole army, and will be thrown into confusion little by little, since only those of one wing will be fighting, that is, those who will necessarily be the first to be engaged because of the oblique attack.

It is sometimes a useful stratagem for an army facing the enemy to retire gradually, as if struck by fear, or to about-face and make a retreat similar to a flight but in order, and then, suddenly turning, to attack their pursuers. For sometimes the enemy, delighted by the belief that their opponents are

¹³ προσβαλλει I': προσβάλλη ν (προσβάλλη GH): προσβάλη
K: προσβάλοι Koraes.

¹⁵ πο πολὺ G.

¹⁷ καταπεπληγμένων νGH.

¹⁹ Koraes: μεταβαλλόμενον Ω.

¹⁴ μέρος νGH.

¹⁶ κέρατος νGH.

¹⁸ ὑποχώρησιν νGH Köchly.

²⁰ ἐνίους F.

ONASANDER

φεύγειν τοὺς ἐναντίους λύσαντες τὰς¹ τάξεις ἐπικέονται² προπηδῶντες ἄλλων ἄλλοι, ἐφ' οὓς ἀκίνδυνον ἐπιστρέψαντας³ μάχεσθαι καὶ αὐτῷ τῷ παρ' ἐλπίδα τοῦ στήναι θάρσει⁴ καταπληξάμενους εἰς φυγὴν αὐθις τοὺς πάλαι διώκοντας τρέπεσθαι.

XXII. [Περὶ τοῦ ἔχειν κεχωρισμένους ἐπιλέκτους εἰς βοήθειαν τῶν καταπονουμένων. περὶ⁵ τοῦ ἔχειν ἐγκρύμματα]⁶

Ἐχέτω δέ που καὶ στρατιώτας λογάδας ἰδία τεταγμένους ἀπὸ τῆς φάλαγγος ὡσπερ ἐφέδρους τοῦ πολέμου πρὸς τὰ καταπονούμενα μέρη τῆς δυνάμεως, ἵν' ἐξ ἐτοίμου τοὺς ἐπικουρήσοντας⁷ ἐπάγη· καὶ ἄλλως οὐκ ὀλίγον ὤνησαν ἀκμητες ἐπελθόντες ἤδη κεκοπιακόσι· τοὺς τε γὰρ τεταλαιπωρηκότας⁸ ἤδη τῶν φίλων ἀνέλαβον καὶ τοῖς πολεμίοις ἐκλελυμένοις ἀκμάζοντες ἐπ-
2 ἔθεντο. γίννοιτο δ' ἂν τι καὶ τούτου⁹ χρησιμώτερον, ἐκ¹⁰ τῆς παρατάξεως ἀπωτέρω σταδίοις, ὅπόσοις ἂν ἀποχρῆν αὐτῷ δοκῆ,¹¹ ἐκπέμψαι¹² μέρος τι¹³ τῆς αὐτοῦ¹⁴ στρατιᾶς¹⁵ ἀπροόρατον τοῖς πολεμίοις, παραγγείλας¹⁶ σφίσιν, ἐπειδὰν συμβάλλῃ¹⁷ τοῖς ἐναντίοις, τότε πυθνομένους παρὰ τῶν σκοποῶν ὀναστάντας¹⁸ ἐπείγεσθαι.¹⁹ καὶ μάλιστα

¹ Om. R.

² PGH: ἐπικέονται F; ἐπικέρονται DENR: ἐπιφέρονται Koraes: ἐπιχέονται Köchly. ³ ἐπιστρέψαντα vPGH.

⁴ θαρσεῖν vGH.

⁵ καὶ περὶ Koraes.

⁶ Title om. F (and no indication of a break): in margin GH. The second sentence is probably a correction of the first, but it seems to be in all the MSS. which have the other also. ⁷ ἐπικουρήσαντας A m².

fleeing, break ranks and rush forward, leaping ahead of one another. There is no danger in turning to attack these men; and those who have for some time been pursuing, terrified by the very unexpectedness of this bold stand, immediately take to flight.

XXII. [*Holding Reserves for the Assistance of exhausted Troops. Holding Reserves in Concealment*]

The general should also have somewhere a picked corps, stationed apart from the phalanx as military reserves, that he may have them ready to give assistance to those detachments of his force that are exhausted. These fresh troops are of not a little advantage in attacking tired men; for, besides relieving those of their own men who are worn out, they attack in their full freshness a wearied enemy. It would be even more advantageous for the general to send a certain part of his army some little distance from the encampment—as far as seems best to him,—unseen by the enemy, with orders to rise up and hasten when the battle is begun, which they will learn from scouts. This is especially to be done

⁸ κεκοπιακότας ν (κοπιακότας A m²): κεκοπτακότας GH.

⁹ τοῦτο νGH. ¹⁰ εἰ νGH.

¹¹ δοκῆ αὐτῶ ν (δοκῆ αὐτῷ GH).

¹² ἐκπέμψη ν (-η GH): ἐκπέμψας A m²: ἐκπέμψοι Koraes.

¹³ τὸ F. ¹⁴ Koraes: αὐτοῦ ἔλ.

¹⁵ στρατίας GH: στρατείας ν.

¹⁶ νGH: παραγγείλαι F: παραγγείλαι τε Kōchly.

¹⁷ συμβάλλει GH: συμβάλλη ν.

¹⁸ ἀναστάντας F: ἀναστήσαντας ν: ἀναστείσαντας GH: ἀνάστησοντας A m².

¹⁹ ἐπάγεσθαι Schwebel and Kōchly.

ONASANDER

τοῦτο ποιητέον, ὅταν προσδόκιμος οὔσα συμμαχία τοῦ καιροῦ καθυστερῇ.¹ δόξαντες γὰρ οἱ πολέμιοι τούτους ἐκείνους εἶναι καὶ συμμάχους ποθὲν² ἤκειν τοῖς ἐναντίοις, ἴσως ἂν ἔτι καὶ προσιόντων πρὶν ἢ συμμῖξαι τοὺς ἐπιβάλλοντας εἰς φυγὴν ὀρμηῆσαιεν,³ οὐ τοσοῦτον, ὅσον ἐστίν, ἀλλὰ πλείον 3 ἐπιέναι πλήθος νομίζοντες. ἄλλως τε καὶ ἐν αὐτοῖς τοῖς δεινοῖς ἐπιφάνειαι πολεμίων ἀπειράστων⁴ ἐκπλήττουσι τὰς ψυχάς· προλαμβάνουσαι⁵ γάρ τι χεῖρον, οὐ⁶ πείσονται,⁷ φοβερώτερον ἐκδέχονται τὸ μέλλον.

4 Ἐκπληκτικωτάτη δ', ἥ⁸ καὶ δραστικωτάτη⁹ μάλιστα πάντων, ἣ κατὰ νότου τῶν¹⁰ πολεμίων αἰφνίδιος ἐπιβολή,¹¹ εἴ πη¹² δυνατὸν γένοιτο προεκπέψαντι¹³ στρατιωτῶν σύνταγμα¹⁴ νύκτωρ ἐκπεριελθεῖν κελευσαι¹⁵ τοὺς πολεμίους, ἵνα κατόπιον αὐτῶν γένωνται πάντες, ὥστε ἔωθεν ἀναστάντας¹⁶ ἐκ τῆς ἐνέδρας μετὰ τὸ συμμῖξαι πρὸς μάχην τὰ στρατεύματα κατὰ τὴν οὐραγίαν ἐπιφαίνεσθαι τοῖς πολεμίοις· οὐδὲ γὰρ φεύγουσιν ἂν¹⁷ ἔτι σφίσιν ἐλπίς ἀπολείποιο¹⁸ σωτηρίας, οὐδ' εἰς τοῦπίσω δυναμένοις¹⁹ ἐπιστραφῆναι διὰ τοὺς ἐξ ἐναντίας μαχομένους, οὐδ' εἰς τὸ πρόσω φέρεσθαι διὰ τοὺς κατόπιον ἐπικειμένους.²⁰

¹ καθύστερῃ F: καθυστερεῖ R.

² Om. vGH.

³ FC: ὀρμηῆσαι vPG (ὀρμηῆσαι H).

⁴ Ω (cf. Galen xiv. 679 ed. Lips.): ἀπροοράτων Köchly (with other suggestions): ἀπειράτων Koraes.

⁵ ὑπολαμβάνουσαι vGH.

⁶ Köchly: οὐ FC (ἢ C in marg.): δ PGH "ceteri codd. ut vid.": ὦν Schwebel.

⁷ πῆσονται R.

⁸ δ' ἢ F: δὲ vGH: δ', ἢ Köchly.

when expected reinforcements come too late for the battle, for the enemy believe that these are the reinforcements arriving from some place or other for their opponents; then possibly even while these reinforcements are still advancing and before they enter the battle, the enemy will take to flight, judging this force to be, not what it is, but much greater. Besides, the arrival of unfamiliar hostile troops at the very moment of battle lowers the morale; for anticipating some greater misfortune than they are about to suffer, soldiers regard the future with greater fear.

Most terrible, or rather most effective, of all manœuvres, is a sudden attack against the enemy's rear. For this purpose, if in any manner it should be possible, a detachment of soldiers should be sent ahead by night, with orders for all to march around the enemy in order to come to their rear, so as to start up from ambush early the next morning, after the battle is begun, and to appear suddenly on the enemy's rear. For no hope of safety would remain for them in flight, and they would be unable to turn backwards, since the opposing army would attack, or to go forward, because of the detachment assailing their rear.

⁹ δραστηριωτάτη vGH.

¹¹ ἐπιβουλή ENR.

¹³ προεκπέμψαι τι vGH.

¹⁵ κελύσας F.

¹⁶ ἀναστάντες vGH.

¹⁷ ἐὰν vGH: om. F (at end of line).

¹⁸ ὑπολείπειτο vGH.

¹⁹ δυναμένους PA m².

²⁰ At this point M is said to have a long interpolated passage, which, since it does not appear in M's archetype G, need not concern us.

¹⁰ Om. F.

¹² καὶ εἰ vGH.

¹⁴ σύστημα vGH.

XXIII. [Περὶ τοῦ ἐν τῷ καιρῷ αὐτῷ τῆς μάχης ἐκφωνεῖν χαρμόσυνα τοῖς ὑπηκόοις· εἰ καὶ ψευδῆ, ὅμως συμφέρει]²

Καὶ δὴ ποτε παριππαζόμενος ἐμβοησάτω τοῖς³ φίλοις, εἰ μὲν ἐπὶ τοῦ δεξιοῦ τύχοι⁴ κέρως ὦν,⁵ “νικῶσιν ἄνδρες⁶ οἱ ἐπὶ τοῦ λαιοῦ τὸ δεξιὸν κέρας τῶν πολεμίων,” εἰ δ’ ἐπὶ τοῦ⁷ λαιοῦ, νικᾶν λεγέτω τὸ φίλιον δεξιόν, ἐάν τε καὶ⁸ κατ’ ἀλήθειαν ἢ τοῦτο γινόμενον⁹ ἐάν¹⁰ τε μή· καὶ γὰρ δὴ¹¹ τὸ ψεῦδος ἀναγκαῖον εἰπεῖν, ὅπου “μέγα νείκος¹² ὄρωρεν.¹³” οἷον βοῆσαι πάλιν αὐτῷ μακρὰν ἀποστατοῦντος τοῦ¹⁴ τῶν πολεμίων ἡγεμόνος ἢ ἐπὶ θατέρου κέρως ὄντος ἢ τὰ μέσα¹⁵ συνέχοντος τῆς φάλαγγος, “τέθνηκεν ὁ τῶν πολεμίων στρατηγός” ἢ “βασιλεύς,” ἢ ὅστις ἂν ποτε ἦ.¹⁶
 2 καὶ ταῦτα χρή βοᾶν οὕτως, ὥσθ’ ἅμα¹⁷ καὶ τοὺς πολεμίους κατακούειν· οἳ τε γὰρ φίλιοι¹⁸ τοὺς σφετέρους ἀκούοντες ἐπικυδεστέρους ἀναθαρροῦσι καὶ διπλάσιοι γίνονται¹⁹ ταῖς προθυμίαις, οἳ τε ἐχθροὶ τὰ σφῶν αὐτῶν ἐλαττώματα πυνθανόμενοι συγκαταπίπτουσι ταῖς διανοίαις, ὥστ’ ἔστιν ὅτε καὶ εἰς φυγὴν ἅμα τῷ δέξασθαι τοιαύτην
 3 φήμην ὀρμᾶν.²⁰ οὕτως πολλάκις συνήνεγκεν καὶ

¹ ὑπακόοις· δ μὲν A.

² Title om. F and no break indicated: in margin GH.

³ τὴν R. ⁴ τύχη v (τύχη GH). ⁵ ὦν F.

⁶ Köchly: ἄνδρες Ω.

⁷ λαιοῦ . . . ἐπὶ τοῦ om. R (A m² with the note λείπει ἐν ἀντ. γράφῳ).

⁸ κᾶν (κᾶν F) τε καὶ Ω: ἐάν τε Köchly: κᾶν τε Koraeas.

⁹ κᾶν τε . . . γινόμενον om. R.

¹⁰ κᾶν GH.

¹² νείκος FGH.

¹¹ FC: δεῖ PGHv(?).

¹³ ὄρωρεν P (ὄρωρεν GH).

THE GENERAL, XXIII. 1 - 3

XXIII. [*Announcing favourable News in the Midst of Battle ; even if false it is advantageous*]

Sometimes the general should ride along the lines and call out to his men, if he happens to be on the right wing, "Our left wing is defeating the right wing of the enemy," or if he is on the left he should say that his right wing is conquering, whether this is true or not,¹ for deceit is necessary when "a great strife has arisen."² For example, when the leader of the enemy is some distance away either on one wing or holding the centre, he should call out, "The general of the enemy has been killed," or "the king," or whoever it may be. And one should shout this in such a manner that the enemy also may hear; for his own soldiers, learning that their side is more successful, are encouraged and doubly eager to fight, while the enemy, learning of the misfortunes of their side, lose heart, so that sometimes they start into flight immediately on hearing such a report. In this

¹ There are many instances of such *salubria mendacia* in antiquity; see especially Herodotus iii. 72; Frontinus i. 11. 6 ff.; ii. 7. 1 ff. Actual instances when one wing was falsely told that the other was victorious are given by Livy ii. 64; Frontinus ii. 4. 11; Polyænus i. 35.

² Homer, *Iliad* xiii. 122.

¹⁴ Om. R.

¹⁵ Köchly: κέρως ἢ ἐπὶ τὰ μέσα Ω: ἢ ἐπὶ τὰ μέσα ὄντος or ἢ τὰ μέσα ἔχοντος or ἢ τὰ μέσα συνέχοντος Koraes.

¹⁶ ἦν F.

¹⁷ F Saguntinus Camerarius: ὡς θαύμα ν.

¹⁸ φλοι R.

¹⁹ γίγνεται PGH.

²⁰ FC: ὄρᾶν GH (and probably P and "ceteri codd. ut vid.," though Köchly gives the obviously false reading ὄρῶν for them).

ONASANDER

τοὺς φίλους¹ ἅμα τοῖς πολεμίοις ἐξαπατήσαι, τοῖς μὲν τὰ κρείττω, τοῖς δὲ τὰ χείρω ψευδόμενον.

XXIV. [Περὶ τοῦ οἰκείου² πρὸς οἰκείου² καὶ γνωρίμους πρὸς γνωρίμους τάττειν]³

Φρονίμου δὲ στρατηγοῦ καὶ τὸ τάττειν ἀδελφοὺς παρ' ἀδελφοῖς, φίλους παρὰ φίλοις,⁴ ἐραστὰς παρὰ παιδικοῖς.⁵ ὅταν γὰρ ἦ τὸ κινδυνεῦον τὸ πλησίον⁶ προσφιλέστερον, ἀνάγκη τὸν ἀγαπῶντα φιλοκινδυνότερον ὑπὲρ⁷ τοῦ πέλας ἀγωνίζεσθαι· καὶ δὴ τις αἰδούμενος μὴ ἀποδοῦναι χάριν ὧν εὖ πέπονθεν αἰσχύνεται καταλιπὼν τὸν εὐεργετήσαντα⁸ πρῶτος αὐτὸς ἄρξαι⁹ φυγῆς.

XXV. [Περὶ τοῦ μὴ δι' ἑαυτοῦ διδόναι τὸν στρατηγὸν¹⁰ τὰ σημεῖα εἴτε τῆς συμβολῆς εἴτε ἄλλης¹¹ τινὸς πράξεως, ἀλλὰ διὰ τῶν ἡγεμόνων¹²]

Πᾶν δὲ παράγγελμα καὶ σύνθημα καὶ παρασύνθημα διδότην διὰ τῶν ἡγεμόνων· ἐπιόντα γὰρ κηρύττειν ἅπασιν ἰδιώτου καὶ ἀπείρου κομιδῆ καθέστηκεν, καὶ χρόνος ἐν τῷ παραγγέλλειν ἀναλίσκεται, καὶ θόρυβος ὁμοῦ πάντων¹³ ἀλλήλους ἐρωτῶντων.¹⁴ εἶθ' ὁ μὲν προσέθηκέ τι πλεῖον¹⁵ ὧν ὁ στρατηγὸς εἶπεν, ὁ δ' ἀφείλετο τοῦ ῥηθέντος

¹ φίλοις vGH.

² AENRGH: οἰκοῖς P "et ceteri codd. ut vid."

³ Title om. F: in margin GH.

⁴ φίλοις F.

⁵ FC: ἐραστὰς παρὰ παιδικοῖς om. PGH "ceteri codd. ut vid."

⁶ F: τοῦ πλησίον PGH "ceteri codd. ut vid.": πλησίον τὸ Kœchly: τῷ πλησίον Koraes.

⁷ ὑπὸ F.

⁸ ENR Camerarius indicatè a break here.

⁹ ἀρξασθαι vGH.

THE GENERAL, xxiii. 3 - xxv. 1

way it is very often useful to deceive both one's own army and that of the enemy by false news, good for the former, but bad for the latter.

XXIV. [*In the Ranks Friends must be placed by Friends and Acquaintances by Acquaintances*]

It is the part of a wise general to station brothers in rank beside brothers, friends beside friends, and lovers beside their favourites.¹ For whenever that which is in danger near by is more than ordinarily dear the lover necessarily fights more recklessly for the man beside him. And of course one is ashamed not to return a favour that he has received, and is dishonoured if he abandons his benefactor and is the first to flee.

XXV. [*The General must not give the Signal for Battle or any other Action to his Army in Person but through his Officers*]

The general should give every command or watchword or countersign through his officers, for to come and give orders personally to the whole army is the act of an unpractised and inexperienced commander. Time is lost in passing orders down the line, and confusion arises, as all the soldiers question each other at the same time. One man through ignorance adds something to what the general has said and

¹ See the Introduction, p. 343 f.

¹⁰ Schwebel: του στρατοῦ A Rigaltius H (G has lost all but στρα in binding) "alii codd.": τοῦ στρατηγοῦ ENR.

¹¹ GH: εἶτε ἄλλης om. v (AP?).

¹² ἡμετέρων GH (ἡμετέρ[G). Title om. F and no break indicated: in margin GH.

¹³ πάντας F.

¹⁴ ἐρωτώντων ἀλλήλους vGH.

¹⁵ FGH: πλέον v.

ONASANDER

2 παρὰ τὴν ἄγνοιαν. δεῖ¹ δὲ τοῖς πρώτοις ἡγεμόσιν εἰπεῖν, ἐκείνους δὲ ἀπαγγεῖλαι τοῖς μετ' αὐτούς, εἶτα τούτους τοῖς κατόπιν,² εἰθ' ἐξῆς ἄχρι τῶν τελευταίων, τοὺς πρώτους τοῖς³ ὑπὸ πόδα⁴ σημαίνοντας· οὕτως γὰρ ἐν τάχει καὶ μετὰ κόσμου καὶ μεθ' ἡσυχίας εἴσονται, παραπλησίον⁵ τοῦ παραγγέλματος τοῖς φρυκτωροῦσι γινομένου.⁶
 3 καὶ γὰρ ἐκείνων, ὅταν ὁ πρῶτος ἄρῃ τὸν φρυκτόν, ὁ δεύτερος τῷ⁷ μετ' αὐτὸν ἐπύρσευσεν, εἰθ' ὁ τρίτος τῷ τετάρτῳ, καὶ τέταρτος πέμπτῳ,⁸ καὶ πέμπτος ἕκτῳ⁹ καὶ καθ' ἓνα πάντες¹⁰ ἀλλήλοις, ὥστ' ἐν ὀξεί δια μέλους σταδίων τὸ σημανθὲν ὑπὸ τοῦ πρώτου πάντας ἐπιγνῶναι.

XXVI. [Περὶ τοῦ μὴ μόνον συνθήματα, ἀλλὰ καὶ παρασυνθήματα¹¹ διδόναι]¹²

Τὸ δὲ παρασύνθημα μὴ διὰ φωνῆς λεγέσθω, ἀλλὰ διὰ σώματος γινέσθω, ἢ νεύματι¹³ χειρὸς ἢ ὄπλων¹⁴ συγκρούσει ἢ ἐγκλίσει δορατίου ἢ παραφορᾶ ξίφους, ἵνα μὴ μόνον γενομένης ποτὲ ταραχῆς¹⁵ πιστεύσωσι τῷ λεγομένῳ συνθήματι—τοῦτο γὰρ δύνανται καὶ πολέμιοι καταλαβέσθαι πολλάκις
 2 ἀκούοντες—, ἀλλὰ καὶ τῷ παρασυνθήματι.¹⁶ χρησιμώτατον δέ που τοῦτο καὶ πρὸς τὰς ἑτερογλώσσους συμμαχίας τῶν ἐθνῶν· οὔτε γὰρ λέγειν οὔτε ξυνιέναι δυνάμενοι¹⁷ φωνῆς ἀλλοτρίας αὐτῷ τῷ παρα-

¹ εἰ F.

² αὐτοὺς τούτοις κατόπιν F.

³ τοῖς vGH.

⁴ ὑποπόδας F.

⁵ παραπλησίον GH: παραπλήσιον v: παρὰ τοῦ παραπλησίον R.

⁶ FGH: γινομένου v.

⁷ FP: τὸν vGH.

⁸ καὶ τέταρτος πέμπτῳ added by Koraeas.

⁹ ὁ πέμπτος τῷ ἕκτῳ vGH.

another omits something. But one should communicate his orders to his higher officers and they should repeat them to the officers next below them, who in turn pass them to their subordinates, and so on to the lowest, the higher officers in each case telling the orders to those below them. In this manner the soldiers will learn the commands quickly with order and calmness, just as a message is carried by fire-signals. For after the first signaller uplifts his fire, the second signals to the next, and the third to the fourth, and the fifth to the sixth, and one by one each follows the other, so that in a short time, over a distance of many stades, the message signalled by the first is known to all.

XXVI. [*On giving both Watchwords and Countersigns*]

He should give the countersign not by the voice but by some gesture, as a wave of the hand, or the clash of weapons, or dipping a spear, or by a side-wave of his sword, in order that when confusion arises the soldiers may not have to trust to the spoken watchword alone—for the enemy hear this so often that they are able to get it—but also to the countersign. This is most useful in the case of allies who speak a different language, for, unable to speak or to understand a foreign tongue, they differentiate between

¹⁰ FC: καθ' ἐν (καθὲν G: καθἔν H) ἅπαντες vGH.

¹¹ GHEN: περὶ συνθημάτων A "ceteri."

¹² Title om. F without indication of break: in margin GH: before ἵνα μὴ AR.

¹³ M (conjecture): νεῦμα F: νεύματος P vGH.

¹⁴ δπλου R (well thought of by Köchly but certainly wrong).

¹⁵ γενομένου ποτὲ ταραχοῦ R. ¹⁶ F indicates a break here.

¹⁷ οὐτ' ἐχόντων λέγειν οὔτε ξυνιέναι δυναμένων R.

ONASANDER

συνθήματι κρίνουσι τό τε φίλιον καὶ τὸ¹ πολέμιον.
 διδόνσθω δὲ ταῦτα, κἂν μὴ μάχεσθαι μέλλωσιν,²
 ἐν ταῖς παρεμβολαῖς πρὸς τὰς ἀδήλους ταραχάς.

XXVII. [Περὶ τοῦ μὴ λύειν τὰς τάξεις μήτε ἐν
 ταῖς διατάξεσι μήτε ἐν ταῖς ὑποχωρήσεσι]³

Παραγγελλέτω δὲ καὶ τὰς ὑποχωρήσεις ἐν
 τάξει ποιεῖσθαι καὶ τὰς⁴ διώξεις, ἵνα ἥττόν τε
 σφαλλόμενοι βλάπτωνται⁵ μὴ κατ' ἄνδρα σποράδες
 ἐν ταῖς φυγαῖς ὑποπίπτοντες τοῖς πολεμίοις,
 πλείονά τε⁶ κατορθοῦντες βλάπτωσι κατὰ τάξεις
 καὶ λόχους ἰσχυρότεροι τοῖς φεύγουσιν ἐπιφανό-
 μνοι, πρὸς δὲ καὶ ἀσφαλέστεροι· πολλάκις γὰρ
 ἀτάκτως⁷ ἐπιφερομένους οἱ πολέμοι θεασάμενοι
 συμφρονήσαντες αὐθις ἐκ μεταβολῆς αὐτῶν κατα-
 στάντες εἰς τάξιν παλίντροπον⁸ ἐποίησαντο τὴν
 δίωξιν· ὅλως δὲ μηδὲν σφισιν ἄμεινον εἶναι
 λεγέτω⁹ τοῦ μένειν ἐν τάξει μηδ' ἐπισφαλέστερον
 τοῦ λύειν.

XXVIII. [Περὶ τοῦ¹⁰ δι' ἐπιμελείας ἔχειν τὸν¹¹
 στρατηγὸν λαμπρὸν ἐκτάττει τὸ στράτευμα]¹²

Μεμελημένον δ' ἔστω τῷ στρατηγῷ¹³ λαμπρὸν
 ἐκτάττει τὸ στράτευμα τοῖς ὅπλοις, ῥαδίᾳ¹⁴ δ' ἦ

¹ Added by Köchly. ² καὶ . . . μέλλουσιν vGH.

³ AGH: ὑποχωρήσεσιν v Köchly. Title om. F without indication of break: in margin GH. ⁴ Om. vGH.

⁵ βλάπτονται GH: βλαπτόμενοι σφάλλωνται (σφάλλονται P)
 P "ceteri codd. ut vid."

⁶ πλείονα δὲ vGH: πλείονά τε Koraes. ⁷ ἀταράκτως F.

⁸ παλίστροφον GH Rigaltius "ceteri codd. ut vid."

⁹ λεγόντων vGH.

THE GENERAL, xxvi. 2 - xxviii. 1

friends and enemies by this countersign. One should instruct the army in these signals in camp, even if it is not about to fight, as a protection against confusion and uncertainty.

XXVII. [*Soldiers should never leave the Ranks whether in Formation or in Retreat*]

One should command both retreats and pursuits to be made in formation, so that, if defeated, the soldiers may suffer less injury, when in their flight they encounter the enemy, by not being scattered, man by man, and, if successful they may inflict greater injury on the enemy by keeping their ranks and companies unbroken, appearing stronger to the fugitives, and moreover being safer themselves. For often the enemy, observing their opponents advancing without order, by a concerted plan about-face, form ranks once more and reverse the pursuit. In a word, the general should say that nothing is more advantageous to his men than remaining in rank, and nothing more dangerous than breaking ranks.

XXVIII. [*The General must be attentive to the Splendour of the Army's Equipment*]

The general should make it a point to draw up his line of battle resplendent in armour¹—an easy matter,

¹ This was a principle upon which Julius Caesar laid great emphasis (Suetonius, *Julius*, 67; Polyænus viii. 23. 20).

¹⁰ τοῦ μὴ δι' PGH Rigaltius "ceteri codd. ut vid.": τοῦ δι' AENM (by conjecture).

¹¹ Om. A.

¹² Title om. F: in margin GH.

¹³ FCP: τὸν στρατηγὸν GH Rigaltius "ceteri codd. ut vid."

¹⁴ ῥηϊδία R.

THE GENERAL, xxviii. 1 – xxix. 3

requiring only a command to sharpen swords and to clean helmets and breast-plates. For the advancing companies appear more dangerous by the gleam of weapons, and the terrible sight brings fear and confusion to the hearts of the enemy.

XXIX. [*Shouting in the Midst of Battle*]

One should send the army into battle shouting, and sometimes on the run, because their appearance and shouts and the clash of arms confound the hearts of the enemy. The dense bands of soldiers should spread out in the attack before coming to close quarters, often waving their swords high above their heads toward the sun. The polished spear-points and flashing swords, shining in thick array and reflecting the light of the sun, send ahead a terrible lightning-flash of war. If the enemy should also do this, it is necessary to frighten them in turn, but if not, one should frighten them first.

It is sometimes advantageous before a critical battle for the general not to be the first to form a line of battle but to wait within the camp for a time

⁹ *δψεις* R.

¹⁰ *πάταγοι* EN: *πάγοι* PGHA m².

¹¹ FGH: *ὑπὸ* P Rigaltius "ceteri codd. ut vid."

¹² *καὶ πρὸς* vGH.

¹³ *παρεκκλίνοντα* vGH.

¹⁴ *προσάλληλα* vGH.

¹⁵ Köchly: *προσεκπέμπει* F: *ἀντιπέμπει* vGH.

¹⁶ *ταυτῇ* P: *ταύτῃ* v (*ταύτῃ* GH): *ταῦτα* Koraes.

¹⁷ *γίγνουντο* PGH Rigaltius "alii codd. ut vid.": *ἐγίγνουντο*

ENR.

¹⁸ FGH: *δὴ* v: *δεῖ ποτὲ τὲ χρήσιμον* R.

¹⁹ FC: *ἐγγὺς* PGHA m² "cet. codd. ut vid."

²⁰ *ἄχρις* GH Köchly.

ONASANDER

πολεμίῳν παράταξι, ὁποῖα τίς ἐστι καὶ ὡς τέτακται¹ καὶ ἐφ' οἷων ἴσταται χωρίων.

XXX. [Ὅτι δεῖ τὸν στρατηγὸν πρὸ τοῦ πολέμου συλλογίζεσθαι, τίς ὀφείλει² ὑπαντῆσαι κατὰ τὴν συμβολὴν τῷ δεῖνι καὶ τίς τῷ ἄλλῳ³ καὶ οὕτως καθεξῆς ἐξετάζειν⁴ τοὺς ἰδίους ἄρχοντας⁵ πρὸς τοὺς τῶν ἐναντίων]⁶

Εἰτά που τότε⁷ συλλογισάμενον, τίνας τίσι⁸ ἀντιτάττειν χρή καὶ τίνα τρόπον, ὥσπερ⁹ ἀγαθὸν ἰατρὸν προκατανοήσαντα¹⁰ νόσον σώματος ἀντεπάγειν τὰ ἀλεξήματα καὶ τὴν δύναμιν ἐκτάττειν, ὡς ἂν ἄριστ' αὐτῷ δόξαι¹¹ συμφέρειν· ἀναγκάζονται γὰρ οἱ στρατηγοὶ πολλάκις καὶ¹² πρὸς τοὺς ὀπλισμοὺς τῶν ἐναντίων καὶ πρὸς τὰ ἔθνη καὶ πρὸς τὰ ἦθη¹³ τὰ ἴδια στρατεύματα κοσμεῖν καὶ παρατάττειν.

XXXI. [Περὶ τοῦ, ἐὰν οἱ ἐναντίοι προτερεύωσι¹⁴ τῷ ἵππικῷ, ἐκλέγεσθαι στενοὺς τόπους]¹⁵

Ἴπποκρατούντων δὲ τῶν πολεμίῳν, ἐὰν ἦ δυνατόν, ἐπιλεγέσθω¹⁶ χωρία τραχέα καὶ στενὰ καὶ παρ' ὄρη, ἃ¹⁷ ἤκιστα ἵππασίμα, ἢ φυγομαχεῖτω

¹ δὲ τέτακται K: διατέτακται Koraes.

² φίλος R: ὀφείλει Rigaltius. ³ Kschly: τῶν ἄλλων Ω.

⁴ ἐξισάζειν H(?)M (G has lost the middle of the word in binding). ⁵ ἄρχοντα R.

⁶ Title om. F without indication of break: in margin GH (badly mutilated from trimmed margins in G).

⁷ ἘΓΗ (ποῦ GH): τοῦ πότε PR: τοῦτο ποτε Chokier: περὶ τοῦ πότε EN.

THE GENERAL., XXIX. 9 - XXXI. 1

until he observes the battle array of the enemy, its character, arrangement, and position.

XXX. [*The General must decide before Battle who should oppose whom and thus in Order arrange his own Officers against those of the Enemy*]

Next the general must consider which troops to oppose to which of the enemy, and in what manner ; just as a good doctor who foresees an illness of the body, he must bring forward his defences and arrange his forces as it seems to him most advantageous ; for generals are often compelled to equip and marshal their own armies with reference to the armament, nationality, and customs of the enemy.

XXXI. [*Narrow Places must be chosen if the Enemy are superior in Cavalry*]

If the enemy are superior in cavalry, the general should choose if possible a locality that is rough and hemmed in, near mountains which are least suitable for riding, or he should avoid battle so far as he

⁸ FGH: τίνα στήσειν P Rigaltius and all Schwebel's mss.: τίνας δὲ τισιν Koraes. ⁹ ὡσπερ γὰρ vGH.

¹⁰ FGH: καταπρονοήσαντα FNPA m² Rigaltius.

¹¹ δόξη v (δόξη GH).

¹² καὶ . . . παρατάττειν om. ENR Camerarius.

¹³ ἔθῃ vGH.

¹⁴ A: προτερεύουσι vG (προτερεύο[H]).

¹⁵ Title om. F: in margin G (mutilated) H.

¹⁶ ἐκλεγέσθω vGH.

¹⁷ Köchly: παρόρη ἤκιστα F: παρόρια vGH.

ONASANDER

κατὰ δύναμιν, ἕως ἂν ἐπιτηδείους εὖρη τόπους
 2 καὶ τοῖς οἰκείοις ἀρμόζοντας πράγμασιν.¹ ἀπο-
 λελείφθων² δέ τινες καὶ ἐπὶ τοῦ χάρακος οἱ παρα-
 φυλάττοντες τὴν παρεμβολὴν στρατιῶται καὶ πρὸς
 τὴν τῆς ἀποσκευῆς³ φυλακὴν, ἵνα μὴ κατανοήσας
 ὁ στρατηγὸς τῶν πολεμίων ἔρημον ὄντα πέμψῃ
 τοὺς ἀρπασομένους τὰ ἐν αὐτῷ καὶ καταληψομέ-
 νους τὸ χωρίον.

XXXII. [Περὶ τοῦ μηδὲν παρακεκινδυνευμένον
 ποιεῖν τὸν στρατηγόν]⁴

Τοὺς μὲν⁵ γὰρ ἢ τὰ ἴδια καθαιροῦντας⁶ ἐρύματα
 στρατηγούς ἢ ποταμούς διαβαίνοντας ἢ κρη-
 μνοὺς καὶ βάραθρα κατόπιω ποιουμένους τῶν
 φιλίων,⁷ ἢ ἢ μένοντες νικῶσιν ἢ βουλευθέντες
 φεύγειν ἀπόλωνται, οὔτε πάμπαν ἐπαινεῖν οὔτε
 ψέγειν ἔχω· πᾶν γὰρ τὸ παρακεκινδυνευμένον
 μᾶλλον⁸ τόλμης ἐστὶν ἢ γνώμης καὶ τῇ τύχῃ
 2 κεκοινώνηκε πλεῖον⁹ ἢ τῇ κρίσει. ὅπου γὰρ ἢ
 νικῶντα δεῖ κρατεῖν ἢ ἡττηθέντα τοῖς ὅλοις¹⁰
 ἐσφάλλθαι, πῶς ἐνταῦθ' ἂν τις ἢ¹¹ φρονήσει τὸ
 νικᾶν ἢ προαιρέσει τὸ¹² ἡττᾶσθαι μαρτυρήσειεν;
 3 ἐγὼ δὲ στρατιώταις μὲν ἐκ στρατεύματος φιλο-
 τόλμως¹³ κινδυνεύειν ἐπιτρεπτέον¹⁴ εἶναι νομίζω—
 καὶ γὰρ δρῶντές τι μείζον ὤνησαν καὶ παθόντες
 οὐθὲν τοσοῦτον ἐλύπησαν—, στρατεύματι δὲ παντὶ

¹ τάγμασιν Köchly.

² ἀπολελείφθωσαν vGH.

³ παρασκευῆς vGH.

⁴ Title om. FAENPR Saguntinus Camerarius: in margin
 GH: no break indicated FGH.

⁵ Om. GH.

THE GENERAL. xxxi. 1 - xxxii. 3

may until he finds an appropriate place, adapted to his own circumstances. A certain number of soldiers must be left behind at the palisade to guard the camp and the baggage in order that the general of the enemy may not discover that the camp is deserted and send men to plunder its contents and seize the place.

XXXII. [*The General must do nothing rash*]

Generals who destroy their own defences or cross rivers or who post their armies with steep cliffs or yawning gulfs in the rear in order that the soldiers may either stand and conquer or in their desire to escape be killed, I am not wholly able to praise nor yet to blame, for everything that is ventured rashly is rather the part of recklessness than of wisdom, and has a greater share of luck than of good judgment. For in a case when one must either win a victory and prevail, or else be defeated and lose everything, in such a case how could anyone attribute victory to foresight or defeat to deliberate choice? But I do believe that certain soldiers of the army must be allowed to run desperate risks—for if they succeed they are of great assistance, but if they fail they do not cause corresponding loss,—

⁶ μὲν ἀρηται δια καθαιρούντας F. ⁷ φίλων vGH.

⁸ Added by Köchly. ⁹ πλέον vGH. ¹⁰ δπλοῖς R.

¹¹ Köchly: πῶς ἐνταῦθά τις ἦ F: πῶς ἐνταῦθα τῇ σῇ (τῇ σῇ GH) vGH: πῶς ἂν ἐνταῦθά τις ἦ Koræes: πῶς ἐνταῦθα τῷ μικᾶν τῇ φρονήσει K.

¹² τοῦ F.

¹³ φιλοτιμῶς vGH.

¹⁴ ἐπιτραπτέον Rigaltius "ceteri codd. ut vid." A m² GH.

ONASANDER

τὴν ἄδηλον ἐκκυβεύειν τύχην¹ οὐ δοκιμάζω.
 4 μάλιστα δ' ἀμαρτάνειν οὗτοί μοι δοκοῦσιν,² οἳ
 τινες ἐν μὲν τῷ³ νικᾶν ὀλίγα λυπήσειν μέλλοντες
 τοὺς πολεμίους, ἐν δὲ τῷ ἠττᾶσθαι μεγάλα βλάψειν
 τοὺς φίλους ἀποχρῶνται τοιούτοις στρατηγήμασιν.
 5 Εἰ δὲ πρόδηλος μὲν σφισιν ὁ ὄλεθρος⁴ εἴη, κἂν
 μὴ⁵ παραβόλοις ἐγχειρήσωσι στρατηγίαις, πρό-
 δηλος δὲ καὶ ἡ τῶν πολεμίων ἠττηθέντων ἀπώλεια,
 τότε⁶ οὐκ ἂν μοι δόξειεν ἀμαρτάνειν ἀποφράττων
 τὰς φυγὰς τῶν φιλιῶν.⁷ ἄμεινον γὰρ ἐν τῷ τολμᾶν
 ἐπ' ἀδήλω τῷ⁸ τάχα μηδὲ πείσεσθαι τι δεινὸν
 ἅμα καὶ δρᾶσαι ζητεῖν, ἢ ἐπὶ προδήλω τῷ μηδὲν
 δρῶντας ἀπολέσθαι πάντας ἀτόλμως ἡσυχάζειν.⁹
 6 ὑποδεικνύτω¹⁰ μέντοι μὴ μόνον ἐν τοῖς τοιούτοις
 χωρίοις, ὅπου κατ' ἀλήθειαν οὐκ ἔστι σωτηρία
 τοῖς φεύγουσιν, ἀλλὰ καὶ ἐν παντὶ τόπῳ καὶ πάσῃ
 μάχῃ διδασκέτω διὰ πλειόνων, ὅτι τοῖς μὲν
 φεύγουσι πρόδηλος ὁ ὄλεθρος, ὡς ἂν ἤδη μετ'
 ἐξουσίας ἐπικειμένων¹¹ τῶν πολεμίων μηδενὸς
 ἔτι δυναμένου διακωλύειν τοὺς διώκοντας πᾶν¹²
 ὁ βούλονται¹³ διαθεῖναι¹⁴ τοὺς φεύγοντας, τοῖς
 7 δὲ μένουσιν¹⁵ ἄδηλος ὁ θάνατος ἀμυνομένοις. οἳ
 τινες γὰρ πεπεισμένοι τυγχάνουσιν ἐν ταῖς παρα-
 τάξεσιν,¹⁶ ὡς φεύγοντες μὲν αἰσchrῶς ἀπολοῦνται,
 μένοντες δ' εὐκλεῶς τεθνήξονται, καὶ χεῖρον'

¹ τύχειν H.

² Köchly: μάλιστα δ' ἂν οὗτοί μοι δοκοῦσιν F: μάλιστα δ' ἂν οὗτοί (οὔτοί G, οὔτοι H) μοι δοκοῦσιν ἀμαρτάνειν vG11.

³ τὸ F.

⁴ Köchly: σφισιν ὄλεθρος FC: σφισιν (σφίσιν G, σφίσιν II) εἴη PGH Rigaltius "ceteri codd. ut vid."

⁵ ἂν μοι R.

⁶ ἀπώλεια ποτ' F.

⁷ φίλων vGH.

⁸ Om. vGH.

⁹ ἢ ἐπὶ . . . ἡσυχάζειν om. R Camerarius.

THE GENERAL, γxxii. 3 - 7

yet I cannot countenance gambling with the entire army as the stake. Most of all those generals seem to me to be at fault who make use of stratagems which in the event of victory will cause small loss to the enemy, but in defeat the greatest loss to their own army.

If the destruction of one's army is evident, except through the use of some daring strategy, and if the destruction of the enemy by defeat is also evident, then I do not think a general would be at fault in cutting off the retreat of his own army. For it is better, by showing courage at a time when it is uncertain whether one will perhaps escape a severe defeat himself, to endeavour at the very same time to inflict a defeat, rather than, when it is certain that all will perish if they remain inactive, to keep quiet like cowards. He should not only point this out in those localities where in actual fact there is no safety for fugitives, but also in every locality and every battle he must show by many reasons that death is certain for those who flee, since the enemy would at once press on freely, as soon as no one is able to hinder the pursuit, and could dispose of the fugitives as might suit them; but for men who stand and defend themselves, death is not certain. For the men in the lines who chance to believe that if they flee they will perish shamefully while if they remain in rank they will die a glorious death, and who

¹⁰ ὑποδείκνυτο R. ¹¹ ἐπικνειμένων R. ¹² ἅπαν vGH.

¹³ FGH: βούλεται P Rigaltius "ceteri codd. ut vid."

¹⁴ διαθῆναι FH. ¹⁵ φεύγουσιν R. ¹⁶ πράξεσιν vGH.

ONASANDER

- αεί¹ προσδοκῶσι ἐκ τοῦ καταλιπεῖν τὴν τάξιν ἢ ἐκ τοῦ φυλάττειν, ἄριστοι κατὰ τοὺς κινδύνους
 8 ἄνδρες ἐξετάζονται. διόπερ ἀγαθὸν μὲν, εἰ πάν-
 τας οὕτως ἔχειν γνώμης πείσαι² στρατηγός, εἰ
 δὲ μή, ἀλλὰ μέντοι γ³ ὡς πλείστους· ἢ γὰρ
 παντελεῖς περιεποιήσατο⁴ νίκας ἢ μικροῖς ἐλατ-
 τώμασι⁵ περιέπεσε.⁶
- 9 Τῶν δ' ἐκ προλήψεως καὶ πρὶν ἢ συμβαλεῖν
 ἐπινοουμένων στρατηγοῖς⁷ αἱ παρ' αὐτὸν τὸν τῆς
 μάχης καιρὸν ἐπινοιαὶ νίκης καὶ ἀντιστρατηγήσεις⁸
 ἔστιν ὅτε καὶ πλείους καὶ θαυμασιώτεροι⁹ γίνον-
 ται¹⁰ τοῖς¹¹ τὴν στρατηγικὴν ἐμπειρίαν ἠσκηκόσιν,
 ἃς οὐκ ἔστιν ὑποσημῆναι¹² λόγῳ ἢ¹³ προβουλεύσει.
 10 ὡςπερ γὰρ οἱ κυβερνῆται πρὸς μὲν τὸν πλοῦν ἐκ
 λιμένων ἀνάγονται πάντα ἐξηρτυμένοι¹⁴ τὰ κατὰ
 τὴν ναῦν, ἐπειδὴν δ' ἐμπέση χειμῶν, οὐχ ὁ βούλον-
 ται ποιῶσιν, ἀλλ' ὁ ἀναγκάζονται, πολλὰ καὶ¹⁵
 πρὸς τὸν ἀπὸ τῆς τύχης ἐπείγοντα¹⁶ κίνδυνον
 εὐτόλμως παραβαλλόμενοι, καὶ οὐ τὴν ἀπὸ τῆς
 μελέτης εἰσφερόμενοι¹⁷ μνήμην, ἀλλὰ¹⁸ τὴν ἐκ
 τῶν καιρῶν βοήθειαν· οὕτως οἱ στρατηγοὶ τὴν
 μὲν δύναμιν¹⁹ ἐκτάξουσιν, ὅπως σφίσι νομίζουσι
 συνοίσειν, ἐπειδὴν δ' ὁ τοῦ πολέμου περιστῆ
 χειμῶν πολλὰ θραύων καὶ παραλλάττων²⁰ καὶ

¹ Köchly: χείρονα αἰεὶ vGH: χείρον εἰ F.

² πείσαι F: πείσει vGH.

³ Köchly (after Camerarius): ἐπεὶ τοῖς γ' F: ἐπεὶ τοὶ γε (τοὶ γε GH) vGH: εἰ δὲ μή, τοὺς γε πλείστους Koraes.

⁴ περιεποιήσαντο F (corr. by a later hand) vGH.

⁵ περιεποιήσαντο . . . ἐλαττώμασι om. R.

⁶ περιέπεσον vGH: περιέπεσεν Köchly: ἢ γὰρ . . . περιέπεσε om. Camerarius. ⁷ τοῖς στρατηγοῖς vGH.

⁸ Köchly: ἐπινοιαὶ νίκαι ἀντιστρατηγήσεις F: ἐπινοιαὶ καὶ ἀντιστρατηγήσεις vGH. ⁹ θαυμασιώτεροι vGH.

THE GENERAL, XXXII. 7 - 10

constantly anticipate greater dangers from breaking the ranks than from keeping them, will prove themselves the best men in the face of danger. On this account it is a good plan if the general can win over his whole army to this opinion, or, if not all, at least as many as possible, for thus he either gains an absolute victory or meets with but a slight defeat.

Plans and counter-stratagems for victory that are originated at the very moment of battle are sometimes preferable to those which are conceived and contrived by generals in anticipation and before the engagement, and they are sometimes more worthy of remark, in the case of those made by men who are skilled in military science, though they are things which cannot be reduced to rules or planned beforehand. For just as pilots for their voyages, before sailing from the harbour, fit their ship out with everything that a ship requires; yet when a storm blows up they do, not what they wish, but what they must, boldly staking their fortunes against the driving peril of chance and calling to their aid no memory of their past practice but assistance appropriate to the existing circumstances; just so generals will prepare their armies as they believe will be best, but when the storm of war is at hand repeatedly shattering,

¹⁰ γίγνονται GH.

¹¹ τοῖς εἰς vGH.

¹² ἐπισημᾶναι v: ἐπισημᾶναι GHA m²: ἐπισημῆνα (?) C.

¹³ Om. F' which also marks a break after προβουλεύσαι.

¹⁴ ἐξηρτημένοι P: ἐξηρτημένοι GH Rigaltius "ceteri codd. ut vid."

¹⁵ πολλάκις C.

¹⁶ ἐπείγονται Rigaltius.

¹⁷ ἐπιφερόμενοι vGH.

¹⁸ ἀλλὰ καὶ vGH.

¹⁹ οἱ μὲν στρατηγοὶ τὴν δύναμιν F.

²⁰ παραλάττων GH.

ONASANDER

ποικίλας ἐπάγων περιστάσεις, ἢ τῶν ἀποβαινόντων¹
ἐν ὀφθαλμοῖς ὄψις ἐπιζητεῖ τὰς ἐκ τῶν καιρῶν
ἐπινοίας, ἃς ἢ ἀνάγκη τῆς τύχης μᾶλλον ἢ ἡ²
μνήμη τῆς ἐμπειρίας ὑποβάλλει.

XXXIII. [Περὶ τοῦ μὴ τὸν στρατηγὸν αὐτοχειρὶ
πολεμεῖν]³

Μαχέσθω δὲ ὁ στρατηγὸς αὐτὸς προμηθέστερον
ἢ⁴ τολμηρότερον, ἢ καὶ τὸ παράπαν ἀπεχέσθω
τοῦ⁵ τοῖς πολεμίοις εἰς χεῖρας ἵέναι· καὶ γὰρ εἰ
κατὰ⁶ τοὺς ἀγῶνας ἀνυπέμβλητον⁷ ἀνδρίαν εἰσενέγ-
καίτο,⁸ τοσοῦτον οὐδὲν ὠφελῆσαι δύναται στρα-
τευμα μαχόμενος, ὅσον ἀποθανῶν βλάψαι· στρα-
τηγοῦ γὰρ ἡ⁹ γνώμη πλέον ἰσχύει τῆς⁹ ῥώμης·
σώματος μὲν γὰρ ἀνδρία δρᾶσαι τι¹⁰ μέγα καὶ
στρατιωτῆς δύναται, γνώμης δὲ προμηθεῖα βου-
2 λεῦσαι τι κρεῖττον¹¹ οὐκ ἄλλος. ὄνπερ δ' ἂν
τρόπον, εἰ κυβερνήτης ἀφειμένος τῶν οἰάκων, ἂ
δεῖ τοὺς ναύτας¹² ποιεῖν, αὐτὸς πράττοι, κινδυ-
νεύειν ἂν συμβαίῃ τὸ σκάφος, τοῦτον, εἰ στρατη-
γὸς¹³ ἀποστὰς τοῦ γνώμη τι βουλευεῖν ἐπὶ τὰς
τῶν στρατιωτῶν καταβαίνοι χρείας, ἢ τῶν
ὄλων¹⁴ ἀκυβέρνητος ἀμέλεια τὴν ἀναγκαιοτέραν ἄ-
3 πρακτον ποιήσει βοήθειαν. ὅμοιον δὲ κρίνων
τὸν¹⁵ στρατηγὸν ἐμπαρβαλέσθαι¹⁶ τῇ ἑαυτοῦ ψυχῇ¹⁷

¹ FC: ἀπομαινόντων GH: ἀπομενόντων P.

² Om ἢ F.

³ Title om. F: in margin GH.

⁴ ἢ μὴ vGH.

⁵ Om. R.

⁶ εἰ καὶ κατὰ vGH.

⁷ FGH: ὑπέμβλητον P Rigaltius "ceteri codd. ut vid."

⁸ εἰσενέγκατο vGH.

⁹ Om. vGH.

¹⁰ ἀνδρία ἀνδρᾶσαι τι F (ἀνδρῆλαι δρᾶσαι τι GH).

¹¹ κρεῖττων Koracs.

overthrowing, and bringing varied conditions, the sight of present circumstances demands expedients based on the exigencies of the moment, which the necessity of chance rather than the memory of experience suggests.

XXXIII. [*The General should not himself enter Battle*]

The general should fight cautiously rather than boldly, or should keep away altogether from a hand-to-hand fight with the enemy. For even if in battle he shows that he is not to be outdone in valour, he can aid his army far less by fighting than he can harm it if he should be killed, since the knowledge of a general is far more important than his physical strength. Even a soldier can perform a great deed by bravery, but no one except the general can by his wisdom plan a greater one. If a ship's captain leaving the helm should himself do what the sailors ought to do, he would endanger his ship; in the same way, if the general, leaving his function of wise direction, should descend to the duties of a simple soldier, his neglect of the whole situation, due to his lack of governing, will render useless the common soldier's mere routine service. Similar, I think, is the notion which the general gets into his heart

¹² FC: ταῖς αὐταῖς PGH Rigaltius "plerique codd." (Schwebel): om. ποιεῖν GH.

¹³ τοῦτο ποιεῖ στρατηγός· εἰ vGH.

¹⁴ Köchly: ἡ τῶν ἀμεινόνων F: ἡ γὰρ τῶν ἀμεινόνων vGH: perhaps ἡ τῶν ἀμεινόνων can stand. ¹⁵ τὸ τὸν Koraes.

¹⁶ ἐκπαραβάλλεσθαι K: ἐκπαραβαλλέσθαι GH.

¹⁷ ψυχῇ (ψύχη corr. by marg. gloss misplaced at συμπάσης to ψυχῇ GH) τὸ τῆς vGH: ψυχῇ τοῦτο τῷ τῆς Köchly.

ONASANDER

τῷ τῆς συμπάσης, εἰ πείσεται τι, δυνάμει
 ἀκχεῖν· εἰ γάρ, ἐν ᾧ τοῦ σύμπαντος ἡ σωτηρία
 στρατεύματος ἔστω, οὗτος οὐδὲν εἰ τεθνήξεται¹
 πεφρόντικε, τὸ πᾶν αἰρεῖται συνδιαφθεῖραι, καὶ
 ὀρθῶς δ'² ἂν τις αἰτιάσαιτο τοῦτον ὡς ἀπρακτον
 4 στρατηγὸν μᾶλλον ἢ ἀνδρεῖον. ὁ μὲν γὰρ πολλὰ
 γνώμη στρατηγήσας ἀρκεσθήσεται σεμννόμενος
 ἐπὶ ταῖς ἀπὸ ψυχῆς εὐπραγίαις, ὅστις δ' οὕτως
 ἀπειρόκαλός ἐστιν, ὥστ' ἂν,³ εἰ μὴ διὰ μάχης
 εἰς χεῖρας ἔλθοι τοῖς πολεμίοις,⁴ οὐδὲν αὐτὸν
 ἄξιον εἰργασθαι⁵ νομίζειν, οὐκ ἀνδρεῖος, ἀλλὰ
 5 ἄλογος⁶ καὶ τολμηρός ἐστιν.⁷ ὅθεν ἐπιφαίνειν⁸
 μὲν δεῖ⁹ τῷ πλήθει τὸ φιλοκίνδυνον, ἵνα τὴν
 προθυμίαν ἐκκαλήται¹⁰ τῶν στρατιωτῶν, ἀγωνί-
 ζεσθαι δὲ ἀσφαλέστερον, καὶ τοῦ θανάτου μὲν
 καταφρονεῖν, εἴ τι πάσχοι τὸ στράτευμα, μηδ'¹¹
 αὐτὸν¹¹ αἰρούμενον ζῆν, σωζομένου δέ¹² καὶ¹³ τὴν
 ἰδίαν φυλάττειν ψυχὴν· ἤδη γὰρ ἐπικυδέστερα τὰ
 τῶν φιλιῶν¹⁴ ὄντα ποτὲ στρατηγὸς ἀποθανῶν
 ἐμείωσεν· οἱ μὲν γὰρ πταίοντες ἐπανεθάρρησαν
 τὸ ἀντίπαλον ἀστρατήγητον ἰδόντες, οἱ δ' εὐτυ-
 χοῦντες ἐδυσθύμησαν τὸν ἴδιον ἡγεμόνα ζητοῦντες.⁷
 6 στρατηγοῦ δ' ἔστι τὸ παριππάζεσθαι ταῖς τά-
 ξεσιν, ἐπιφαίνεσθαι τοῖς κινδυνεύουσιν, ἐπαινεῖν
 τοὺς ἀνδριζομένους, ἀπειλεῖν τοῖς ἀποδειλιῶσι,
 παρακαλεῖν τοὺς μέλλοντας, ἀναπληροῦν τὸ¹⁵ ἐλ-
 λείπον, ἀντιμετάγειν εἰ δέοι λόχον, ἐπαμύνειν τοῖς

¹ τοῦ σύμπαντος . . . τεθνήξεται om. ENPRV Camerarius.

² Om. vGH.

³ ὥστε vGH.

⁴ FC: τῶν πολεμίων P Rigaltius Schwebel's mss. GH.

⁵ ἐργασται P Rigaltius Schwebel's mss.: ἤργασται GH;
 ἤργασται R.

⁶ Added by Köchly: καὶ del. Koraes.

THE GENERAL, xxxiii. 3 - 6

when he thus disregards the welfare of his whole force in the event of accident to himself; for if he, with whom the safety of the whole army lies, has no care lest he himself should die, he prefers that everyone should die with him, and rightly he would be censured as an unsuccessful rather than a courageous general. He who has accomplished many feats of generalship through his wisdom must be satisfied with the honour for his intellectual successes, but he who is so stupid that, unless he comes to close quarters with the enemy, he believes he has accomplished nothing worthy of mention, is not brave but thoughtless and foolhardy. Hence the general must show himself brave before the army, that he may call forth the zeal of his soldiers, but he must fight cautiously; he should despise death if his army is defeated, and not desire to live, but if his army is preserved he should guard his personal safety, for sometimes the death of a general lessens the glory of his army, since the defeated enemy is encouraged, perceiving that its opponents are without a general, and the successful army is discouraged, feeling the need of its own general. The duty of the general is to ride by the ranks on horseback, show himself to those in danger, praise the brave, threaten the cowardly, encourage the lazy, fill up gaps, transpose a company if necessary, bring

⁷ F indicates a break here.

⁸ ὑποφαίνεω vGH.

⁹ δὴ F.

¹⁰ ἐκκαλεῖται P Rigaltius "cet. codd. ut vid." GH.

¹¹ Köchly: μηδὲ αὐτὸν (?) v: μηδ'αὐτὸν GH: μηδὲ αὐτὸν R: μὴδ' αὐτὸν F.

¹² αἱ, ζεῖν σώζομεν οὐδὲ R.

¹³ FGH Saguntinus Camerarius: om. v.

¹⁴ φίλων vGH.

¹⁵ μέλλοντας ἀναπληροῦν τι RM (conjecture) Camerarius.

ONASANDER

κάμνουσι, προοραῖσθαι τὸν καιρόν, τὴν ὥραν, τὸ μέλλον.

XXXIV. [Περὶ τοῦ εὐεργετεῖν κατὰ τὸ μέτρον ἓνα ἕκαστον τῶν ἀνδραγαθούντων¹]

Ἀνακαλεσάμενος δ' ἐκ τῆς μάχης πρῶτον μὲν ἀποδιδότω τοῖς θεοῖς θυσίας καὶ πομπάς,² αἷς ἐκ τοῦ καιροῦ χρῆσθαι³ πάρεστι, τὰ νομιζόμενα χαριστήρια μετὰ τὴν τοῦ πολέμου παντελῆ νικῆν ἐπαγγελλόμενος⁴ ἀποδώσειν· ἔπειτα τοὺς μὲν ἀρίστους ἐν τοῖς κινδύνοις ἐξετασθέντας τιμάτω δωρεαῖς καὶ τιμαῖς, αἷς νόμος, τοὺς δὲ κακοὺς ² φανέντας κολαζέτω.⁵ τιμαὶ δ' ἔστωσαν μὲν καὶ αἱ κατὰ τὰ⁶ πάτρια καὶ κατὰ⁷ τὰ παρ' ἐκάστοις νόμιμα· στρατηγικαῖ⁸ δὲ αὐταὶ· πανοπλῖαι,⁹ κόσμοι, λαφύρων δόσεις, πεντηκονταρχίαι, ἑκτονταρχίαι, λοχαγίαι, τάξεων¹⁰ ἀφηγήσεις, καὶ αἱ¹¹ ἄλλαι αἱ¹² κατὰ νόμους παρ' ἐκάστοις ἡγεμονίαι· τῶν¹³ μὲν ἰδιωτῶν τοῖς ἀνδραγαθήσασιν αἱ ἥττους ἐξουσίαι, τῶν δὲ ἡγεμόνων τοῖς ἀριστεύσασιν¹⁴ αἱ μείζους ἡγεμονίαι· αὐταὶ γὰρ ἀμοιβαί τε¹⁵ μεγαλόψυχοι τοῖς ἤδη τὸ γενναῖον εἰργασμένοις προτροπαί τε ἀναγκαῖαι τοῖς τῶν αὐτῶν ἐπι-

¹ τὸν ἀνδραγαθοῦντα GH. Title om. F without indication of break: at τῶν μὲν ἰδιωτῶν § 2 (or a little above GH) Ω: in margin GH.

² C: χρηστὰ Ω.

² πομπαῖς F.

⁴ ἐπαγγειλάμενος vGH.

⁵ F indicates a break here.

⁶ GEN: om. FvPH.

⁷ Kochly: καὶ τὰ παρ' F: καὶ παρ' Ω.

⁸ FENR: στρατηγικαῖς P Rigaltius GH "ceteri codd. ut vid."

⁹ ENR: πανοπλίας F: πανοπλῖαι P Rigaltius GH "ceteri codd. ut vid."

¹⁰ λοχαγίαι τάξεων F: τάξεως vGH.

¹¹ Om. vGH.

¹² Del. von Rohden.

aid to the wearied, anticipate the crisis, the hour, and the outcome.

XXXIV. [*Conferring Rewards proportional to the Valour of each*]

On returning from battle, the general should first offer to the gods such sacrifice and festal celebrations as the circumstances permit, promising to offer the customary thank-offerings after complete victory; then he should honour those soldiers who have faced danger most bravely with the gifts and marks of distinction which are usually given, and he should punish those who have shown themselves cowards. Honours should be bestowed according to tradition and custom in each case. Those bestowed by generals¹ are the following: full equipments of armour, decorations, spoils, and appointments to commands such as over fifties, over hundreds, over companies, over squads, and the other parts of command prescribed by the laws of the country in question. The bravest of the private soldiers should receive the lesser commands, and those of his officers who have distinguished themselves should have the higher commands, since these rewards strengthen the self-esteem of those who have deserved well, and encourage others who desire similar rewards.

¹ Or, reading στρατηγικαὶ δὲ αὐταὶ πανοπλῖαι and taking στρατηγικαὶ with πανοπλῖαι (Schwebel and Konstantiniades), the meaning is "full equipments of armour for generals." Possibly the words πεντηκονταρχία . . . ἐκάστοις ἡγεμονία belong after αἱ μείζους ἡγεμονία just below.

¹³ ν indicates a break at this point (but not FGH).

¹⁴ FCEN: ἀριστεύουσι P: -σιν GH Rigaltius.

¹⁵ αἱ ἀμοιβαὶ τε καὶ νGH.

ONASANDER

3 θυμουσαν. ὅπου δὲ τιμὴ μὲν ἀποδίδεται τοῖς ἀγαθοῖς, τιμωρία δ' οὐ παραπέμπεται τῶν κακῶν, ἐνταῦθα καλὰς ἐλπίδας ἔχειν ἀνάγκη τὸ στρατόπεδον· οἱ¹ μὲν γὰρ ἐφοβήθησαν ἀμαρτάνειν, 4 οἱ δὲ ἐφιλοτιμήθησαν ἀνδραγαθεῖν. ἔνθα² μέντοι χρὴ καὶ νικῶντα μὴ κατ' ἄνδρα μόνον ἀμοιβὰς ἐκτίνειν,³ ἀλλὰ καὶ τῷ σύμπαντι στρατεύματι τῶν κινδύνων ἐπικαρπῖαν⁴ ἀποδιδόναι· τὰ γὰρ⁵ τῶν πολεμίων ἐπιτρεπέτω τοῖς στρατιώταις διαρπάζειν,⁶ εἰ⁷ χάρακος ἢ ἀποσκευῆς ἢ φρουρίου κυριεύσειεν, ὅτε⁸ δὲ καὶ πόλεως, εἰ μὴ τι μέλλοι περὶ αὐτῆς 5 χρηστότερον βουλεύειν. οὕτως γὰρ ἂν καὶ μάλιστα⁹ μήπω τέλος εἰληφότος τοῦ πολέμου συνοίσοι¹⁰ πρὸς τὰ μέλλοντα προθυμότερον ἐπὶ τὰς μάχας αὐτῶν ἐξιόντων, εἰ μὴ νομίζομεν τοὺς μὲν θηρευτικούς κύνας δελεάζειν ἀναγκαῖον εἶναι τοῖς κυνηγοῖς αἵματι θηρίων¹¹ καὶ τοῖς τοῦ συλλήφθεντος ζώου σπλάγχνοις, τοῖς δὲ νικῶσι στρατιώταις τὰ τῶν ἡττημένων¹² εἰς προτροπὴν¹³ οὐ μάλα δὴ τι¹⁴ συμφέρον ἀποδιδόναι.

XXXV. α'. [Ὅτι οὐ¹⁵ χρὴ πάντοτε ἐπιτρέπειν τὰς ἀρπαγὰς, καὶ ὅτι τὰ σώματα οὐ χρὴ ἀρπάζειν, ἀλλὰ τὸν στρατηγὸν πιπράσκειν]¹⁶

Τὰς δ' ἀρπαγὰς οὐτ' ἐπὶ πάσης μάχης ἐπιτρεπτόν, οὐδ' αἰεὶ¹⁷ πάντων, ἀλλ' ὧν μὲν, ὧν δ'

¹ At this point GH indicate a break.

² At this point F indicates a break: ἐνταῦθα vGH.

³ ἐκτίνειν vGH.

⁴ FGH: ἐπικαρδίαν P: ἐπὶ καρδίαν ENRV.

⁵ Om. vGH, reading ἐπιτρεπέτω δέ.

⁶ ἀρπάζειν A m².

⁷ ἢ F.

THE GENERAL, xxxiv. 2 - xxxv. 1

Whenever honour is paid to the brave and punishment of the cowardly is not neglected, then an army must have fair expectation; the latter are afraid to be found wanting, the former are ambitious to show prowess. It is not only necessary in victory to distribute rewards to individual men but also to make recompense to the army as a whole for its dangers. The soldiers should be allowed to plunder the possessions of the enemy if they should capture a camp or baggage train or fortress, or sometimes even a city, unless the general intends to put it to a more profitable use. This course will serve well the interests of the future, especially if the war is not ended, since the soldiers will be more eager to enter battle, unless we are to believe that, while huntsmen must entice their dogs with the blood of wild beasts and the entrails of the animal which the dogs have caught, nevertheless it is not at all advantageous to give the possessions of the defeated enemy, as encouragement, to the victorious army.

XXXV. (1) [*Indiscriminate Pillage must not always be permitted; Prisoners must not be regarded as Loot, but must be sold by the General*]

Plundering should not be permitted after every battle nor in the case of all kinds of property, but

⁸ Köchly: *δτε* GH: *δτι* P Rigaltius "alii codd.": *ετι* DERN.

⁹ *βουλεύειν* . . . *μάλιστα* om. F.

¹⁰ Koræes: *συνολσει* Ω. ¹¹ *θηρίου* vGH. ¹² *ήττωμένων* F.

¹³ *προνομήν* vGH. ¹⁴ Om. vGH. ¹⁵ *δτι ού* om. V.

¹⁶ Title in vGH only: om. Ω: in margin GH.

¹⁷ *επι* vGH: *αι* Köchly.

ONASANDER

οὐ, τῶν δὲ σωμάτων ἤκιστα· ταῦτα δὲ πιπράσκειν
 2 τὸν στρατηγόν. εἰ δὲ χρημάτων δέοι καὶ δαπάνης
 κοινῆς καὶ μεγάλης, καὶ ὅσα ἄγεται καὶ φέρεται
 3 πάνθ' ὡς αὐτὸν ἀναπέμπεσθαι κηρυττέω. γνώη¹
 δ' ἂν αὐτὸς ἄριστα πρὸς τοὺς καιροὺς, εἰ τὰ²
 πάντα δέοι λαμβάνειν, εἴτ' ἐκ μέρους, εἴτε μηθὲν
 ὦν³ ἔτυχεν· οὐ γε μὴν ἔστι⁴ πολέμου⁵ καὶ τοῖς
 κοινοῖς εἶναι χρημάτων δαψίλειαν καὶ τοῖς στρα-
 τιώταις ἀνεπικώλυτον⁶ ὠφέλειαν· ἤδη δὲ καὶ
 παρὰ τοὺς⁷ τῶν ἡττημένων⁸ πλοῦτους καὶ παρὰ
 τὰς τῶν τόπων εὐδαιμονίας αἱ ὠφέλειαί σφισι
 δαψιλέστεραι γίνονται.⁹

β'. [Περὶ αἰχμαλώτων]¹⁰

4 Τοὺς δὲ αἰχμαλώτους, εἰάν ὁ πόλεμος ἔτι συν-
 εστῶς¹¹ ᾗ, μὴ κτεινέτω, μάλιστα μὲν τῶν¹² πρὸς
 οὓς ἐστὶν ὁ πόλεμος, κἂν δοκῇ οἱ, τοὺς συμμάχους¹³
 ἀναιρεῖν, ἤκιστα δὲ καὶ τοὺς¹⁴ ἐνδοξοτάτους καὶ
 λαμπροὺς παρὰ τοῖς πολεμίοις, ἐνθυμούμενος τὰ
 ἄδηλα τῆς τύχης καὶ τὸ παλίντροπον τοῦ δαιμονίου
 φιλοῦντος ὡς τὰ πολλὰ νεμεσᾶν, ἢν' εἴ¹⁵ τινων
 αὐτοῖ¹⁶ ἢ σωμάτων, ὦν πολὺς πόθος, ἢ φρουρίου

¹ γνώη vGH.

² εἴτε vGH.

³ FGH: om. P Rigaltius "alii codd. ut vid."

⁴ Kochly: οὔτε μὴν ἐστὶ F: οὐ (οὐ GH) γέ μὴν ἐστὶν Rigal-
 tius GH and "codd. ut vid.": μὴν . . . κινδύνοις (Ch. xxxvii.
 4) om. G, by loss of one leaf in binding.

⁵ πολέμω Koraes.

⁶ ἐπικώλυτον Rigaltius Schwebel "ceteri codd. ut vid.":
 ἐπικωλυτὸν H.

⁸ ἡττημένων FH.

⁷ παρ' αὐτοὺς F.

⁹ γίνονται H.
¹⁰ Title om. FHA: without indication of break in FH.

THE GENERAL, xxxv. 1 - 4

only in the case of certain things, and least of all of prisoners, for these should be sold by the general. If he lack money and resources to meet a large public expense, he should order that all the plundered property, including the live-stock, be turned over to him. The general will know what is best according to the circumstances, whether to seize everything or a part or nothing, of that on which he chances; certainly it is not the characteristic of war to cause both abundance of wealth to the community and unlimited gain to the private soldiers; in fact it happens sometimes that the gains of a victorious army are proportionate to the wealth of the vanquished and the prosperity of their territory.

(2) [*Prisoners*]

Prisoners, if the war is still in progress, the general should not kill—at the very most he may kill, if he thinks best, the allies of those against whom the war is directed, but least of all those who stand in highest repute and position among the enemy, remembering the uncertainties of chance, and the reversals caused by providence, which usually brings retribution. His purpose should be, if his army should capture certain prisoners for whom there is a great desire in their own country, or some strong-

¹¹ FCH: *συστοδς* P: *συνεγδς* EM (G missing) NV: *συνεχως* R (?).

¹² Capps: *τοις Ω*.

¹³ *δοκήση (δοκήσει Η) τοις συμμαχοις* vH Saguntinus Camerarius: *μάλιστα μὲν, κὰν δοκῆ αὐτοῖς, πρὸς οὓς ἐστὶν ὁ πόλεμος, τοὺς συμμαχοὺς* Köchly.

¹⁴ *καὶ τότε τοὺς* Köchly.

¹⁵ Köchly after C: *νεμεσῶν εἰ* F: *νεμεσῶν ἢ* PH Rigaltius "ceteri codd. ut vid."

¹⁶ *αἰθις* F: *αὐτοῖς* H.

ONASANDER

κρατήσαιεν,¹ ἱκανὰ ἀντικαταλλάγματα² δοὺς ἔχῃ³
 κομίσασθαι τὰ τῶν φιλιῶν,⁴ ἢ τότε γε⁵ μὴ
 5 βουλομένων ἐνδίκως εἰς ἴσον ἀμύνηται.⁶ μετὰ
 δὲ τὰ κατορθώματα καὶ τοὺς κινδύνους ἐπιτρε-
 πέσθων⁷ αὐτοῖς εὐωχίαι τε καὶ κλισίαι καὶ πόνων
 ἀνέσεις,⁸ ἢ εἰδότες, οἷον τέλος ἐστὶ τοῦ⁹ μαχο-
 μένουσιν νικᾶν, ὑπομένωσι τὰ δυσχερῆ πάντα πρὸ
 τοῦ νικᾶν.

XXXVI. α'. [Περὶ τοῦ θάπτειν τοὺς ἐν πολέμῳ
 ἀναιρουμένους]¹⁰

Προνοεῖσθω δὲ τῆς τῶν νεκρῶν κηδείας, μήτε
 καιρὸν μῆθ' ὄραν μήτε τόπον¹¹ μήτε φόβον προ-
 φασιζόμενος, ἂν τε τύχη νικῶν, ἂν τε ἠττώμενος·
 ὁσία¹² μὲν γὰρ καὶ ἡ πρὸς τοὺς ἀποικομένους
 εὐσέβεια, ἀναγκαῖα δὲ καὶ ἡ πρὸς τοὺς ζῶντας
 2 ἀπόδειξις. ἕκαστος γὰρ τῶν στρατιωτῶν ὡς
 αὐτὸς ἀμελούμενος, εἰ πεσὼν ἔτυχεν, παρ' ὀφθαλ-
 μοῖς ὄρων τὴν τύχην καὶ ὑπὲρ τοῦ μέλλοντος
 καταμαντευόμενος, ὡς οὐδ' αὐτός, εἰ¹³ τεθναίη,
 ταφισόμενος ἐπαχθῶς φέρει τὴν ἀτύμβευτον¹⁴
 ὕβριν.

¹ κρατήσαι PH Rigaltius (κρατήσαι H).

² ἀντικαταλλάγματα H.

⁴ φιλιῶν vH.

⁶ ἀμύνηται PH.

⁸ ἀνεύσεις R.

¹⁰ Title om. F without sign of break : in margin H without sign of break.

¹¹ FPH : μήτε τόπον om. v.

¹³ FC : οὐ H Rigaltius " ceteri codd. ut vid. " : ὡς δ' αὐτὸς τεθναίη R.

THE GENERAL, xxxv. 4 – xxxvi. 2

hold, that he may be able by giving enough in exchange to redeem the property of his friends, or at least then, should the enemy not wish to deal justly with him, that he may protect himself on equal terms. After successful engagements and the dangers of battle, the general should allow feasts and celebrations¹ and holidays, in order that the soldiers, knowing what happens as the result of victory by battle, may patiently undergo all hardships necessary for such victory.

XXXVI. (1) [*On the Burial of the Fallen*]

The general should take thought for the burial of the dead, offering as a pretext for delay neither occasion nor time nor place nor fear, whether he happen to be victorious or defeated. Now this is both a holy act of reverence toward the dead and also a necessary example for the living. For if the dead are not buried, each soldier believes that no care will be taken of his own body, should he chance to fall, observing what happens before his own eyes, and thereby judging of the future, feeling that he, likewise, if he should die, would fail of burial, waxes indignant at the contemptuous neglect of burial.

¹ The exact meaning of κλισίαι is uncertain, although it seems to denote entertainments at which the participants sat or reclined upon couches. Zur-Lauben (followed by Koraes) renders the word by 'spectacles,' Konstantiniades by 'συμπόσια.'

ONASANDER

β'. [Περὶ τοῦ ἐπανορθοῦσθαι τὴν ἐλάττωσιν]¹

3 Εἰ δὲ ἤττωτο,² παραμυθησόμενος³ τοὺς ἀνα-
σωθέντας ἐκ τῆς μάχης⁴ ἐφεδρευέτω, καιρὸν⁵
ἔνθα που καὶ μᾶλλον οἰόμενος ἐπανορθώσασθαι
4 τὴν ἐλάττωσιν. εἰώθασι γὰρ ὡς τὰ πολλὰ μετ'
εὐπραγίας⁶ οἱ στρατιῶται ῥαθυμότερον ἐκλύεσθαι
περὶ τὰς φυλακάς· ἢ γὰρ τῶν πέλας καταφρόνησις
ἀμελείας⁷ σφίσι γίνεται αἰτία⁸ τῶν οἰκειῶν,
οὕτως τε πολλάκις τὰ εὐτυχήματα πλείον ἔβλαψε
5 τῶν δυστυχημάτων. ὁ μὲν γὰρ πταίσας ἐδι-
δάχθη καὶ φυλάξασθαι⁹ τὸ μέλλον, ἐξ ὧν ἔπαθεν,
ὁ δὲ τοῦ δυστυχεῖν¹⁰ ἄπειρος οὐδ',¹¹ ὡς δεῖ φυλάξαι
6 τὰς εὐπραγίας,¹² ἔμαθεν. εἶτ'¹³ αὖ νικῶν τὴν¹⁴
αὐτὴν ἐχέτω¹⁵ προμήθειαν ὑπὲρ τοῦ μὴ παθεῖν¹⁶
ἀμελῶν, ἣν ἂν εἰς τὸ¹⁷ δρᾶσαι τι⁸ τοὺς ἐχθροὺς
ῥαθυμοῦντας εἰσενέγκαιτο.¹⁸ φόβος γὰρ εὐκαιρος¹⁹
ἀσφάλεια προμηθῆς, ὡς²⁰ καὶ καταφρόνησις ἄκαι-
ρος²¹ εὐεπιβούλευτος τόλμα.

XXXVII. [Περὶ τοῦ ἐν καιρῷ εἰρήνης μὴ
ἀφυλάκτως²² εἶναι]²³

Ἄνοχὰς δὲ ποιησόμενος μηδ'²⁴ ἐπιτιθέσθω μηδ'
αὐτὸς ἀφυλάκτος ἔστω· ἀλλὰ τὸ μὲν ἦσυχον

¹ Koraes: title om. Ω: without sign of a break FH: "De cladiibus acceptis sarcicndis" Rigaltius Schwebel.

² ἤττωτω H: ἤττωνται v.

³ παραμυθησόμενος vH.

⁴ τοὺς ἐκ τῆς μάχης ἀνασωθέντας vH.

⁵ καιρῷ Schwebel: ἐφεδρευέτω τῷ καιρῷ Koraes.

⁶ εὐπραγίας PV A m².

⁷ ἀμέλεια v (ἀμελεία H) defended by von Rohden.

⁸ Added by Kochly.

⁹ φυλάξας PH Rigaltius "alii codd. ut vid.": φυλάξαι EN.

(2) [*Encouragement in Defeat*]

If the general be defeated, by encouraging the soldiers who have survived the battle, he should prepare for another bout, thinking that very likely there is at such a time an even better opportunity to retrieve defeat. For, as a rule, soldiers after victory are accustomed to relax their vigilance, for their contempt for their near-by opponents causes carelessness of their own interests, and thus good fortune has often done more harm than misfortune. For he who has suffered a defeat has been taught to guard in future against that from which he has suffered, but he who is inexperienced in misfortune has not even learned that it is necessary to guard his success. On the other hand, if victorious, the general should take the same precautions against suffering harm through negligence which he would use in trying to inflict harm upon the enemy if they were off their guard. Seasonable fear is wise precaution, as ill-timed contempt is recklessness that invites attack.

XXXVII. [*Precautions in Time of Peace*]

After making a truce he should neither make an attack nor himself remain unguarded ; he should, on

-
- ¹⁰ δυστοιχεῖν H. ¹¹ οὐχ vH.
¹² φυλάξασθαι τὰς δισπραγίας Koraes. ¹³ οὐτ' vH.
¹⁴ ἡ τὴν F. ¹⁵ ἔχει vH. ¹⁶ παχεῖν A m².
¹⁷ Koraes: ἦν ἀρ' εἰς τὸ F: ἦν ἀρ' ἐστὸ H: ἀρ' ἐς τὸ Rigaltius
 Schwebel: ἀρεστὸν R. ¹⁸ εἰσηνέγκατο vH. ¹⁹ εὐκαιρῶς H.
²⁰ Om. v: προμηθῶς καὶ H. ²¹ ἄκρος R (A m²).
²² ἀφίλακτος ARH (?) Koraes: ἀφίλακτον P.
²³ Title om. F: in margin H.
²⁴ μήτ' (om. επιτιθέσθω μηδ') αὐτὸς II.

ONASANDER

ἐχέτω πρὸς τοὺς πολεμίους, ὡς ἐν¹ εἰρήνῃ, τὸ δ'
 2 ἀσφαλὲς εἰς τὸ μὴ παθεῖν, ὡς ἐν πολέμῳ. δεῖ
 γὰρ οὐκ ἀσύνθηκον ἐν σπονδαῖς εἶναι οὐτ'² αὐτόν
 τι φθάνειν ἀσεβὲς δρώντα, ἀλλ' ὑποπτον,³ ὡς
 φυλάττεσθαι τὸ ἀπὸ τῶν⁴ πολεμίων ὑπουλον.
 3 ἄδηλοι γὰρ αἱ τῶν σπεισαμένων γινώμει. καὶ
 παρὰ σοὶ μὲν ἔστω τὸ βέβαιον τοῦ μὴ ἀδικῆσαι⁵
 διὰ τὸ εὐσεβὲς, παρὰ δὲ τοῖς πολεμίοις ὑπονοεῖσθω
 τὸ μὴ πιστόν διὰ τὸ ἀπεχθές.⁶ ἀσφαλῆς γὰρ
 οὗτος⁷ καὶ προμηθῆς, ὅς οὐδὲ βουλευθεῖσι τοῖς
 πολεμίοις ἐπιθέσθαι τὸν τοῦ δύνασθαι παρασπον-
 4 δῆσαι καιρὸν ἀπολείπει.⁸ οἷτινες δ' ἐπὶ τοῖς
 θεοῖς⁹ ποιοῦνται τὴν ὑπὲρ ὧν ἂν πάθωσιν ἐκδικίαν,
 εὐσεβὲς¹⁰ μὲν φρονοῦσιν, οὐ μὴν ἀσφαλῆ ποιοῦσιν.¹¹
 5 κομιδῇ γὰρ ἀνοήτων¹² ἐστὶν ἐλπίδι τοῦ τοὺς¹³ παρα-
 σπονδήσαντας ἐκτίσειν δίκας ἀπρονοήτους¹⁴ ἔχειν
 τοὺς περὶ σφῶν κινδύνους,¹⁵ ὥσπερ αὐτοὺς¹⁶ σώζε-
 σθαι μέλλοντας ἅμα τῶν¹⁷ τοὺς ἐχθροὺς ἀπόλλυσθαι,¹⁸
 ἐξὸν¹⁹ μετὰ τῆς τῶν²⁰ ἰδίων πραγμάτων ἀσφαλείας²¹
 πεῖραν λαμβάνειν τῆς τῶν πολεμίων ἀσεβείας· οὕτως
 γὰρ αὐτοὶ²² τε διὰ τὸ προμηθὲς οὐκ ἂν πταίσαιεν
 ἐπιβουλευθέντες, ἀσεβήσουσι τε οἱ πολέμιοι τῶ ἐπι-
 χειρῆσαι καὶ δοκεῖν πεποικηκέναι ἂν,²³ εἰ²⁴ ἐδυνήθησαν.

¹ Del. A m².

² οὐκ F: οὔτε H: οὐδ' Koracs.

³ C: ἀδοπτον Ω (αὐτο πτον H).

⁴ τῶν ἀπόντων (for τὸ ἀπὸ τῶν) F: τὸ ὑπὸ τῶν R.

⁵ FC: ἀδικεῖσθαι ENPH Rigaltius "ceteri codd. ut vid.":
ἀδικῆσθαι A m².

⁶ FH: ἀπαχθὲς Rigaltius "quidam codd. ut vid."

⁷ οὕτως PH Rigaltius "alii codd. ut vid."

⁸ F: ἐπιλείπει H Schwebel: ἐπιλείπει Koracs: διαλείπει
Rigaltius (no report of other mss.).

⁹ FH: τοὺς θεοὺς v.

¹⁰ εὐσεβῆ vH.

¹¹ Added by Köchly.

¹² FHV (r): ἀνοήτων v.

THE GENERAL, xxxvii. 1 - 5

the one hand, make no move against the enemy, as in peace, but, on the other, he should be protected against danger, as in war. He must not break faith in a treaty, nor be the first to commit any sacrilegious act, but he must be suspicious enough to watch for festering deceit on the part of the enemy, for the intentions of those with whom the treaty has been concluded are uncertain. Let your part be a firm resolution not to transgress, because of the sacred nature of the treaty, but suspect a breach of faith on the part of the enemy due to their hostility. That general is wise and cautious who affords the enemy, even when they desire to attack, no opportunity to break their compact. Those who leave to the gods revenge for what they have suffered are piously minded but certainly do not act safely. For it is absolute folly to be careless of the danger to oneself in the hope that treaty-breakers will pay the penalty—as if one would himself be saved as soon as the enemy perish!—when it is possible to make trial of the irreligion of the enemy while at the same time safeguarding one's own interests. With this precaution one will save himself from defeat if plotted against, but the enemy will commit sacrilege both if they attempt a breach of the truce and if they let it be seen that they would have done it if they could.

¹³ FK: τούτους H "cet. odd. ut vid." Rigaltius Schwebel.

¹⁴ ἀπρονοήτους Oldfather: ἀπρονοήτως Ω.

¹⁵ τοῦ . . . κινδύνου VH. ¹⁶ αὐτός R (A m²).

¹⁷ τὸ R. ¹⁸ ἀπόλυσθαι PH.

¹⁹ FH (Leo, *Tactica*, xvi. 20 ἐξεστίν): ἐξ ὧν v.

²⁰ FR: om. v. ²¹ ἀσφαλείαις F.

²² αὐτοῖς F: αὐτός R. ²³ Added by Oldfather.

²⁴ καὶ εἰ v: καὶ del. Koraes after Leo, *Tactica*, xvi. 20: om.
τε οἱ πολέμιοι, ἐπιχειρήσαι, δοκεῖν πεποιηκέναι F.

ONASANDER

XXXVIII. α'. [Περὶ τοῦ τὰς¹ προσαγομένης πόλεις
ἐν ἀδείᾳ ἔχειν καὶ φιλανθρωπίᾳ]²

Ταῖς δὲ προσχωρούσαις³ πόλεσιν, εἴ τινες
ἐπιτρέποιν αὐτὰς⁴ ἀρξάμεναι, φιλανθρώπως καὶ
χρηστῶς προσφερέσθω⁵ προσαγάγοιτο⁶ γὰρ ἂν
οὕτως καὶ τὰς ἄλλας. ἢ γὰρ ἐλπίς τοῦ τῶν
αὐτῶν τεύξεσθαι⁷ δελεάζουσα προσάγεται⁸ τοὺς
2 πολλοὺς αὐτοὺς ἐκόντας⁹ ἐγχειρίζειν. ὅστις δὲ
πικρῶς¹⁰ εὐθύς καὶ πολεμικῶς¹¹ προσφέρεται κύ-
ριος γενόμενος πόλεως ἢ διαρπάζων ἢ κτείνων ἢ
κατασκάπτων,¹² ἄλλοτριωτέρας διατίθησι τὰς ἄλλας
πόλεις, ὥστε καὶ τὸν πόλεμον αὐτῶ¹³ ἐπίπονον
3 καὶ τὴν νίκην δύσελπιν κατασκευάζειν· εἰδότες
γάρ, ὡς ἀπαραίτητόν¹⁴ ἐστὶν ἢ τῶν ὑποχειρίων¹⁵
πρὸς τοῦ κρατήσαντος¹⁶ τιμωρία, πᾶν ὅτιοῦν
ὑπομένουσι καὶ ποιεῖν καὶ πάσχειν ὑπὲρ τοῦ μὴ
4 παραδοῦναι τὰς πόλεις. οὐθὲν γὰρ οὕτως κατα-
σκευάζει γενναίους, ὡς φόβος¹⁷ ὧν μέλλουσι
πείσεσθαι κακῶν¹⁸ εἴξαντες· ἢ γὰρ προσδοκία τῶν
δεινῶν ἐκ τοῦ καθυφείσθαι¹⁹ τὰ σφέτερα δεινῆν
5 ἐντίθησι φιλοτιμίαν ἐν τοῖς κινδύνοις. χαλεπαὶ
δὲ²⁰ αἱ πρὸς τοὺς ἀπεγνωσμένους πείραι μάχης·
οὐδὲν γὰρ χρηστότερον ἐλπίζοντες ἐκ τοῦ παρα-
χωρεῖν ὧν πείσονται κινδυνεύοντες αἰροῦνται μετὰ

¹ Om. A.

² Title om. F; in margin H without mark of break.

³ προσχωρούσαις Λ m².

⁴ αὐτὰς F.

⁵ προσφερέσθων F.

⁶ προσαγάγοιτο H.

⁷ τεύξασθαι vH.

⁸ προσάγει vH.

⁹ C: ἔχοντας (om. αὐτοὺς) F; οὕτως ἔχοντας vH.

¹⁰ πικρὸς vH.

¹¹ πολεμικὸς vH; πολεμικὸς εὐθύς R.

¹² κατακόπτων v; κατὰ κόμπτων H.

¹³ αὐτῶ F; ἐπίπονον αὐτῶ or αὐτῶ v (ἐ. αὐτῶ H).

XXXVIII. (1) [*Treatment of surrendered Cities with Trust and Humanity*]

If any cities should open their gates in surrender early in the war, the general should treat them in a manner both humane and advantageous, for thus he would induce the other cities also to submit. The enticing hope of a similarly fortunate fate leads the majority to surrender voluntarily. But he who acts in a harsh and savage manner, immediately after becoming master of a city, plundering, slaying, and destroying, makes other cities hostile, so that the war becomes laborious for him and victory difficult of attainment. Since they know that the punishment of the conquered by the conqueror is merciless, they are ready to do and suffer anything rather than surrender their cities. For nothing makes men so brave as the fear of what ills they will suffer if they surrender; indeed the expectation of the evils which will ensue from their subjection produces a terrible pertinacity in danger. Moreover, fighting is dangerous against desperate men,¹ who expect from surrender no amelioration of the fate which will be theirs if they continue to fight, and therefore prefer, if they can inflict much harm, also

¹ The idea was well expressed by Vespasian, *μη συμπλέεσθαι θανατῶσιν ἀνθρώποις· οὐδὲν γὰρ ἀλκιμώτερον εἶναι τῆς ἀπογνώσεως* (Josephus, *Bell. Iud.* iii. 7. 18).

¹⁴ ἀπαραίτητός vH.

¹⁵ FH: ὑποχείρων PA m² Rigaltius "ceteri codd. ut vid."

¹⁶ Köchly (but no note): τοὺς κρατήσαντας FH Rigaltius Schwebel Koraes and apparently v.

¹⁷ οὐθέν . . . φόβος om. R Camerarius.

¹⁸ κακῶς vH.

¹⁹ καθυφέσθαι F.

²⁰ With χαλεπαὶ δὲ G resumes.

ONASANDER

6 τοῦ πολλὰ δρᾶν καὶ πάσχειν. ὅθεν αἱ πολιορκίαι τοῖς ᾧδε¹ στρατηγοῖς ἄφροσι καὶ τεθθρωμένοις² ταλαίπωροι³ γίνονται⁴ καὶ πολυχρόνιοι, ποτέ⁵ δὲ καὶ ἀτελεῖς, οὐχ ἥκιστα δὲ σφαλεραὶ τε⁶ καὶ ἐπικίνδυνοι.

β'. [Πῶς χρηστέον προδόταις]⁷

7 Τοῖς δὲ προδόταις τὰς τε πίστεις καὶ τὰς ἐπαγγελίας φυλαττέτω, μὴ διὰ τοὺς γεγονότας, ἀλλὰ διὰ τοὺς ἐσομένους, ἢ εἰδότες, ὡς ὀφείλεται σφισι χάρις, ἐλόμενοι⁸ τὰ τῶν πολεμίων ἐπὶ τὰς αὐτὰς εὐεργεσίας τρέπωνται.⁹ λαμβάνει γὰρ τι⁸ μᾶλλον ὁ¹⁰ προδότῃ διδοὺς ἢ χαρίζεται.¹¹ διὸ χρῆ προθύμως ἐκτίνειν¹² τὰς ἀμοιβάς· οὐ γὰρ δικαστῆς τῆς ἀδικηθείσης πόλεως ἐστίν, ἀλλὰ στρατηγὸς τῆς ἑαυτοῦ πατρίδος.

XXXIX. α'. [Περὶ τοῦ τὸν στρατηγὸν ἐν γνώσει εἶναι τῆς τῶν ἄστρων¹³ κινήσεως]¹⁴

Πρὸς δὲ τὰς ἐπιθέσεις καὶ τὰς ἐκ προδοσίας¹⁵ νυκτερινὰς καταλήψεις τῶν πόλεων¹⁶ οὐκ ἄπειρον εἶναι δεῖ τῆς ὑπεργείου κατὰ τὴν νύκτα φορᾶς τῶν

¹ τοιοῖσδε vGH.

² FGH: τεθθρωμένοις P Rigaltius "ceteri codd. ut vid.": τεθειραμένοις R.

³ FCD: om. vGH.

⁴ γίνωνται GH.

⁵ πολὺ GH: πολλοὶ Rigaltius A m²: πολλὰ Schwebel Koraes.

⁶ Koraes: σφαλερώτεροι καὶ Ω.

⁷ Koraes: title om. FAGH without indication of a break in any one of these mss.: "Fidem proditoribus esse servandam" Rigaltius Schwebel.

THE GENERAL, xxxviii. 5 – xxxix. 1

to suffer much. On this account the sieges of such insensate and savage generals become wearisome and long drawn-out, sometimes even fail of accomplishment, and are extremely dangerous and precarious.

(2) [*How to treat Traitors*]

One should keep promises and pledges to traitors, not on account of what they have done but of what others will do, in order that these, knowing that gratitude will be due them, may choose the interests of their country's enemies and turn to the same sort of service. For he who gives to a traitor receives much more than he bestows. On this account it is necessary to pay the reward cheerfully, for the general is not an avenger of the betrayed city but the commander of the army of his own country.

XXXIX. (1) [*On the General's Knowledge of the Courses of the Stars*]

In night attacks and surprises of towns through treason, the general must know the heavenly courses

⁸ ἐλομένοις v: ἐλλομένοις GH.

⁹ τρέπονται PGH.

¹⁰ ἡ R.

¹¹ χαρίζεσθαι R.

¹² ἐκτείνειν vGH.

¹³ τῆς ἀστρώου P: τοῦ ἀστρου Schwebel.

¹⁴ Title om. FENR: in margin but mostly illegible in photographs GH.

¹⁵ FENRGH: προδοσία P: προδοσία Rigaltius "ceteri codd. ut vid."

¹⁶ Schwebel following Camerarius: τῶν πολέμων F: τῶν πολεμίων PGH "ceteri codd. ut vid." Saguntinus.

ONASANDER

ἀπλανῶν, ἐπεὶ πολλάκις ἀπράκτους ἕξει τὰς ἐπι-
 2 βολάς.¹ ἔστιν γὰρ ὅτε συντέτακταί τις τῶν
 προδοτῶν τρίτην ἢ τετάρτην ἢ ὀπόστην² ἂν τις³
 εὐκαιρον ὥραν νομίζῃ⁴ τῆς νυκτός, ἀνοίξειν τὰς
 πύλας ἢ τινὰς κατασφάξειν τῶν ἐπὶ τῆς πόλεως
 ἀντιπραττόντων⁵ ἢ φρουρᾶ⁶ τῶν ἔνδον πολεμίων
 ἐπιθήσασθαι· κἄπειτα δυεῖν⁷ θάτερον συμβέ-
 βηκεν, ἤτοι⁸ θᾶττον ἢ ἔδει προσπελάσαντα⁹ τὸν
 τῶν πολεμίων στρατὸν¹⁰ κατάφωρον¹¹ γενέσθαι,
 πρὶν ἢ τοὺς προδότας ἐτοίμους εἶναι, καὶ οὕτως
 ἀποκωλυθῆναι τῆς πράξεως, ἢ ὑστερήσαντα¹² τοῖς
 μὲν προδόταις αἴτιον γενέσθαι θανάτου φωρα-
 θεῖσιν, αὐτὸν δὲ μηδὲν τῶν προκειμένων¹³ ἀνύσαι.
 3 διόπερ χρή καὶ¹⁴ τὴν ὁδὸν τεκμαιρόμενον, ὅθεν¹⁵
 ἐξοδεῦσαι δεῖ, καὶ τῶν¹⁶ σταδίων καὶ τῆς ὥρας¹⁷
 στοχαζόμενον, ὅσον¹⁸ εἰς τὴν¹⁹ πορείαν ἀναλώσει,
 καὶ ἀπὸ τῶν ἄστρον ὀρῶντα,²⁰ πόσον¹⁹ τὸ παρωχη-
 κὸς ἤδη καὶ πόσον τὸ ἀπολειπόμενον μέρος, οὕτως
 ἀκριβῶς συλλογισάμενον,²¹ ἵνα μήτε φθάσῃ μήτε
 βραδύνῃ, πρὸς αὐτὴν ἤκειν τὴν ὥραν τοῦ συν-
 τεταγμένου καιροῦ καὶ ἔτι προσιόντα²² ἀκούεσθαι
 καὶ ἐντὸς εἶναι τῶν τειχῶν.

¹ ἐπιβουλὰς GH “libri scripti tantum non omnes” (Schwebel).

² ὀπαστήν F (corr. AB) GH: ὀπως τὴν Rigaltius “ceteri codd. ut vid.”

³ Om. K Koraes.

⁴ νομίζει GH.

⁵ FGH: ἀντιπαραπαττόντων Rigaltius A m² “ceteri codd. ut vid.”

⁶ φρουρὰ R.

⁷ FCKGH (κάπι ν: καπι δυεῖν GH): κἄπειτα δυοῖν Koraes: κἀπιδυεῖν Rigaltius: κἀπιδυοῖν EN: κάπι δυοῖν R Schwebel.

⁸ εἴτε ν (εἴτε GH).

⁹ προσπερὰς R: πρὸς πύλας suggested by Köchly.

of the stars by night, otherwise his plans will often be of no avail. For instance, some traitor has appointed the third or the fourth, or whatever hour of the night he considers most favourable, for opening the gates or slaying some of the opposing faction in the town or attacking the hostile garrison within the town; then one of two things has happened; the general has reached the camp of the enemy too early and has been detected before the traitors are ready and has been thwarted in his attempt, or else he has arrived too late and has thus been the cause of the traitors' being detected and put to death and of his own failure to accomplish any of his plans. Accordingly he should form an estimate of the road, deciding at what point he is to set out; then he must determine the distance and the time—how much of each he will have to spend on the journey;—and, finally, he must, from his observation of the stars, estimate exactly what part of the night has passed and what part remains, in order that he may arrive neither too early nor too late; then he must get there at precisely the appointed time, so that news of his attack may not reach the enemy until he is actually inside the fortifications.

¹⁰ τῷ . . . στρατηγῷ vGH.

¹¹ κατάφορον Fm¹ corr. m².

¹² FR: ὑστερήσαντας GH Rigaltius "ceteri codd. ut vid."

¹³ προειρημένων R.

¹⁴ FGR: om. v.

¹⁵ ἔσον vGH: ἔσων K Korais.

¹⁶ καὶ τῶν added by Köchly.

¹⁷ τὴν ὥραν vGH.

¹⁸ ἔσην vGH.

¹⁹ Om. vGH.

²⁰ ὁρῶν F.

²¹ FC: συλλογισάμενος PGH A m² Rigaltius "ceteri codd. ut vid."

²² Köchly: προσιόντας Ω.

ONASANDER

β'. [Πῶς ἡμέρας αἰρεῖν χρὴ πόλιν]¹

- 4 Εἰ δ' ἡμέρας ἀναστήσας ἄγοι στρατεύματα πόλεις ἐκ προδοσίας ληψόμενος κατὰ τὴν συγκειμένην ὥραν, τοὺς κατὰ τὴν ὁδὸν ὑποπίπτοντας ἅπαντας² προαποστέλλων ἱππεῖς συλλαμβανέτω, μὴ τις τῶν ἐπὶ τῆς χώρας φθάσας ἀποδραμῶν μηνύσῃ τὴν ἔφοδον τῶν πολεμίων, ἀλλ' αἰφνιδίως³ ἀφυλάκτοις ἢ ἐπιφάνεια γένηται⁴ τοῦ στρατεύματος.
- 5 ἐπελθόντα δ' ἐξαίφνης ἀπροσδοκῆτοις χρὴ, κἂν μὴ⁵ κατὰ προδοσίαν μέλλῃ⁶ λαμβάνειν, ἀλλ' ἐκ προρρήσεως ἀγωνίζεσθαι διὰ μάχης, μὴ ἀναβάλλεσθαι, ἀλλ' ὡς ὅτι μάλιστα φθάσειν προσβάλλοντα⁷ εἴτε φρουρίῳ εἴτε χάρακι εἴτε πόλει, μάλιστα δ' ὅτ' ἂν ὀλίγον εἶναι δοκῇ⁸ τὸ φίλιον
- 6 στρατεύματα καὶ τῶν ἐχθρῶν ἐλαττούμενον· αἱ γὰρ⁹ ἀπρόληπτοι¹⁰ τῶν πολεμίων ἐπιφάνειαι διὰ τὸ παράλογον ἐκπλήττουσι τοὺς ἐναντίους, κἂν ὡσι κρείττους, ἕως¹¹ ἂν γε συνθεωρήσωσιν¹² αὐτοὺς¹³ καὶ βουλευσασθαι καὶ ἀναθαρρήσαι καιρὸν λάβωσι, κατὰ μικρὸν ἀναγκάζονται καταφρονεῖν· οὕτως
- 7 χρονοζομένων εἶναι δοκεῖ. διὸ πολλάκις ἤδη τινὲς τῷ παραδόξῳ τῆς ἐπιφανείας καταπληξάμενοι τοὺς ἐναντίους ἢ ταχὺ καὶ ἄκοντας ὑπέταξαν¹⁴ ἢ ποιεῖν ἐκόντας ἠνάγκασαν τὰ προσταττόμενα.

¹ Koracs without ms. authority: Saguntinus alone indicates a heading with the words "De urbe interdiu occupanda."
² Om. R.

³ αἰφνιδίως F: Köchly suggests αἰφνίδιος.

⁴ γίγνηται vGH.

⁵ κἂν μὴ om. F.

⁶ μέλλει GH.

(2) [*How to capture a City by Day*]

If setting out by day, he lead his army to capture at an appointed hour towns that are to be betrayed, he should send horsemen ahead to seize every one met on the road, that no native of the country may run ahead and warn of the approach of their enemy but that the army may appear suddenly to the enemy and catch him off his guard. He must fall unexpectedly on an unsuspecting enemy. even if he is not expecting to seize the towns through treachery but to fight openly after a declaration of war, and he must not hesitate but strive in every way to attack fort or camp or town before his advance is known, especially if he knows that his own army is small and inferior to that of the enemy. For unexpected appearances of an enemy, because they are unforeseen, terrify their opponents, even should the latter be stronger; but at length, if those who have been taken by surprise should observe their own forces or get the chance to plan and renew their courage, they gradually and of necessity come to despise their foes; in this way the beginning of a war sometimes seems more terrible than the latter part. On this account, armies have often so terrified their opponents by the unexpectedness of their appearance that they have either quickly subdued them against their will or else have forced them to agree to comply with their own demands.

⁷ προβάλλειν τα F: προβάλλοντα P.

⁸ δοκεῖ GHR.

⁹ αἴ γε F.

¹⁰ ἀπρόσληπτοι vGH.

¹¹ ὡς vGH.

¹² συνθεωρήσουσιν PGH.

¹³ Kóchly: αὐτοὺς Ω.

¹⁴ ὑπέταξεν PGH

ONASANDER

XL. [Περὶ πολιορκίας]¹

Πολιορκία δὲ στρατιωτῶν² ἀνδρίαν³ ἐπιζητεῖ καὶ στρατηγικὴν ἐπίνοιαν καὶ μηχανημάτων παρασκευήν· ἀσφαλῆς μέντοι καὶ μὴ ἦττον ἀπροόρατος τῶν πολιορκουμένων ἔστω· τὸ γὰρ ἐπιβουλεύομενον, ὅτ' ἂν οἱ⁴ κακοῦ τυγχάνει γνώσκη, ² τηρεῖ μάλλον τὸ ἐπιβουλεύον·⁵ ὁ μὲν⁶ γὰρ ἔξω κινδύνου δοκῶν εἶναι πράττει τι τῶν προκειμένων, ὁπότε⁷ ἂν αὐτῷ⁷ δόξῃ,⁸ ὁ δ' ἐν αὐτῷ τῷ κινδυνεύειν⁹ ὑπάρχων ζητεῖ φθάσας¹⁰ δρᾶσαι,¹¹ ὁπότε⁷ ἂν καιρὸν λάβῃ· διὸ χρὴ τὸν πολιορκοῦντα καὶ τάφρω καὶ χάρακι καὶ φυλακαῖς τὸ ἴδιον ἀσφαλίζεσθαι ³ στρατόπεδον· καὶ γὰρ οἱ μὲν πολιορκοῦντες, ὅτι ἂν μέλλωσι πράττειν, ὀρῶνται τοῖς ἀπὸ τοῦ τείχους, οἱ δὲ πολιορκούμενοι πρόβλημα τὸ τεῖχος ἔχοντες ἀόρατοι πολλάκις ἐκχυθέντες διὰ πυλῶν ἢ μηχανὰς ἐνέπρησαν ἢ στρατιώτας ἐφόνευσαν ἢ, ὅτι κατὰ χεῖράς σφισιν εἶη, τοῦτο ἐποίησαν.

XLI. [Περὶ τοῦ ἔχειν ἐνέδρας τὸν πολιορκοῦντα πρὸ τῶν πυλῶν]¹²

Ἡκιστα δ' ἂν τοῦτο τολμήσαιεν,¹³ εἰ παρὰ πύλαις¹⁴ καὶ πυλίσι μικραῖς λόχους ὁ πολιορκῶν

¹ Om. F without indication of break ENRM (G imperfect here) Camerarius: iu margin H (margin of G patched) without indication of break.

² Köchly: στρατηγῶν Ω.

³ ἀνδρείαν GH.

⁴ FGH: εἰ EN: ὅ, τι R.

⁵ ἐπιβουλεύουενον DPG HA m² Rigaltius "ceteri codd. ut vid.": ἐπιβουλεύον G m².

THE GENERAL, XL. 1 - XLI. 1

XL. [*Sieges*]

A siege demands courage on the part of the soldiers, military science on the part of the general, and equipment of machines of war. The general must take no fewer precautions and be no less observant than the enemy; for the army attacked, when it knows just what its danger is, guards especially against the army attacking. The army that believes itself out of danger does what work is at hand when it pleases, but that which is in danger strives to surprise its enemy by dealing him a blow whenever it has an opportunity. Hence it is necessary for the besieging general to fortify his camp with trenches, palisades, and guards. For whatever the besiegers intend to do can be seen from the walls; but the besieged, with the wall as a shield, often without detection pour through the gates and burn the machines or kill the soldiers or do whatever damage comes to their hands.

XLI. [*Ambush laid by the Besieger before the Gates of a Town*]

The besieged would by no means attempt this if the besieging general should post at both large and

⁶ ὁ μὲν om. DPGHA m² Rigaultus "ceteri eodd. ut vid."

⁷ αὐτὸ R.

⁸ δόξει PGH.

⁹ τὸ κινδυνεῦον R.

¹⁰ Kochly: φθάσαι Ω.

¹¹ FPGH (δράσαι GH): καὶ τι δράσαι v: ἢ δράσαι K: δράσαι τι Kochly.

¹² Title om. F: without indication of break AENR Sagramntinus Camerarius: in margin without break GH.

¹³ τολμήσειν R (τολμήσειν A m²).

¹⁴ ταῖς πύλαις vGH.

ONASANDER

προκαθίσῃ¹ στρατηγὸς τοὺς τὰς αἰφνιδίους ἐκδρομὰς τῶν πολεμίων² ἀποκωλύσοντας, ἐπεὶ κἂν
 2 πολλάκις λάθοιεν ἐπιθέμενοι τοῖς ἐκτός. χρήσιμοι δὲ τὰ πολλὰ νύκτωρ τοῖς πολιορκουσίαι αἱ προσβολαί· τοῖς γὰρ ἔνδον οὐ δυναμένοις ὄραν τὰ γινόμενα³ διὰ τὸ σκότος δεινότερα δοκεῖ τὰ πραττόμενα, καὶ τὴν πρόληψιν ἀναγκάζονται χαλεπωτέραν ἔχειν τῶν κατὰ ἀλήθειαν ἐνεργουμένων, ὅθεν ταραχαί τε⁴ καὶ θόρυβοι γίνονται οὐδενός⁵ δυναμένου σωφρονεῖν ἐν τοῖς τοιούτοις, ἀλλὰ καὶ πολλὰ τῶν οὐ δρωμένων ὡς γίγνεται⁶ λεγόντων, οὐθ' ὅπη⁷ προσβαλοῦσιν⁸ εἰδέναί δυναμένων, οὐθ' ὀπόσοι,⁹ οὐθ' ὀποίοις μέρεσι,¹⁰ διαδρομαὶ δὲ δεῦρο κάκεισε καὶ βοαὶ καὶ θάμβη Πανικὸν ἔχοντα τάραχον.

XLII. α'. [Περὶ τοῦ ὅτι ὁ¹¹ φόβος ψευδῆς μάντις¹² ἐστίν]¹³

Ὁ γὰρ φόβος ψευδῆς μάντις, ἃ δέδοικε, ταυτ' οἰήσεται καὶ γίνεσθαι, καὶ πᾶν τὸ ἐν νυκτί, κἂν μικρὸν ἦ, φοβερώτερον τοῖς πολιορκουμένοις· οὐδεὶς γὰρ, ὃ βλέπει, λέγει διὰ τὸ σκότος, ἀλλὰ πᾶς, ὃ ἀκούει· καὶ ἐνός που φανέντος ἢ δυεῖν¹⁴ ἐπὶ τείχους πολεμίων τὸ πᾶν ἤδη στράτευμα τῶν τειχῶν ἐπιβεβηκέναι δόξαντες ἀπετράπησαν,¹⁵ ἐρήμους καταλιπόντες ἐπάλξεις καὶ πύλας.¹⁶

¹ προκαθίσας F.

² F: πόλεων PGH—nothing known about other mss.

³ γινόμενα GH. ⁴ Om. vGH. ⁵ μηδενός von Rohden.

⁶ γίνεσθαι (om. ὡς) v: γίγνεσθαι (om. ὡς) GH Koraes.

⁷ GH (οὐθ' ὅπη): οὐ τὸ πῆ F: οὐθ' ὅπη P: οὐθ' ὅτι Rigaltius
 "alii codd. ut vid."

⁸ προσβάλλουσιν P Rigaltius "alii codd. ut vid.": πρὸς βάλλουσιν GH.

THE GENERAL, xli. 1 – xlii. 1

small gates companies of soldiers to prevent sudden sallies, since otherwise the defenders might without warning attack the besiegers. Attacks by night are generally advantageous to the besiegers, since the besieged are unable to see what is happening, on account of the darkness, and everything seems more terrible to them, and they are compelled to regard the attack as more dangerous than it really is. Hence tumult and confusion arise; no one is able to use sober judgement in such circumstances, but many things that are not happening are said to be happening; and the besieged is not able to know from what direction the enemy is attacking, nor in what numbers, nor with what forces, and men run hither and thither, while the shouting and consternation cause disorder and panic.

XLII. (1) [*Fear is a false Prophet*]

Fear is a false prophet and believes that what it fears is actually coming to pass. At night every trifling occurrence seems more terrible to the besieged, for on account of the darkness no man tells what he sees but always what he hears. If one or two of the enemy appear somewhere on the walls, the defenders, believing that the whole army has already mounted the walls, turn and flee, leaving the battlements and gates undefended.

⁹ ὡς . . . ὁπόσοι om. R Camerarius: οὐθ' ὁπόσοι om. vGH.

¹⁰ Kóchly: κλίμασι Fv: κλίμασιν GH: κλήμασι EKN: κλίμαξι Saguntinus. ¹¹ Om. Kóchly. ¹² μάντης A.

¹³ Title om. FPVGH: without indication of even a break FGH. ¹⁴ δυοῖν v: δοιεῖν GH.

¹⁵ ἀνετράπησαν vGH.

¹⁶ FC: πόλεις vG: πόλις H.

ONASANDER

β'. [Ὅτι αὐτὸν χρῆ παράδειγμα τὸν στρατηγὸν
γίγνεσθαι τοῖς στρατιώταις]¹

- 2 Εἰ δέ τι διὰ χειρὸς ὁ στρατηγὸς ἐξεργάσασθαι
σπεύδοι, μὴ ὀκνεῖτω² πρῶτος αὐτὸς ὀφθῆναι
ποιῶν· οὐ γὰρ οὕτως ταῖς ἀπὸ τῶν κρειττόνων
ἀπειλαῖς ἀναγκαζόμενοί τι ποιούσιν, ὡς ταῖς ἀπὸ
τῶν σεμνοτέρων διατροπαῖς· ἰδὼν γάρ³ τις τὸν
ἡγεμόνα πρῶτον ἐγχειροῦντα καὶ ὅτι δεῖ σπεύδειν
ἔμαθε⁴ καὶ μὴ ποιεῖν ἠδέσθη⁵ καὶ ἀπειθεῖν ἐφο-
βήθη· καὶ οὐκ ἔθ' ὡς δοῦλον ἐπιταττόμενον
διετέθη τὸ πλήθος, ἀλλ' ὡς ἐξ ἴσου⁶ παρακαλού-
μενον διετράπη.

γ'. [Περὶ πολιορκητηρίων μηχανημάτων]⁷

- 3 Πολλῶν δὲ καὶ ποικίλων ἐκ τῶν μηχανῶν⁸
πολιορκητηρίων χρήσεται κατὰ δύναμιν⁹ ὁ στρα-
τηγός· οὐ γὰρ ἐπ' ἐμοὶ τὸ λέγειν,¹⁰ ὅτι δεῖ
κριοὺς ἔχειν¹¹ ἢ¹² ἐλεπόλεις ἢ σαμβύκας ἢ
πύργους ὑποτρόχους¹³ ἢ χελώνας χωστρίδας ἢ
καταπέλτας· τῆς γὰρ τῶν πολεμουμένων τύχης
καὶ πλούτου καὶ δυνάμεως ἴδια ταῦτα καὶ τῆς¹⁴
τῶν ἐπομένων ἀρχιτεκτόνων¹⁵ ἐπινοίας¹⁶ εἰς τὰς

¹ Korae apparently without ms. authority: FGH do not indicate even a break (the same holds for all the sub-titles in Ch. xlii.): "Imperator suo exemplo milites provocat" Rigaltius Schwebel.

² FC: μὴ om. vGH: κινεῖτω vGH: κινεῖτο A m².

³ δέ vGH.

⁴ ἔμασθαι A m².

⁵ ἠδέσθαι RA m².

⁶ ἐπίσου vGH: ἐπίσον A m².

⁷ Korae (see on sub-title to § 2): "De machinis ad opugnationem" Rigaltius Schwebel.

(2) [*The General must set a good Example to his Soldiers*]

If the general is in haste to finish some enterprise that he has on hand, he should not hesitate to be prominent in the work, for soldiers are not forced to activity so much by the threats of their immediate superiors as by the influence of men of higher rank. For a soldier seeing his officer the first to put his hand to the task not only realizes the need of haste too but also is ashamed not to work, and afraid to disobey orders; and the rank and file no longer feel that they are being treated as slaves under orders but are moved as though urged by one on the same footing as themselves.

(3) [*Siege Engines*]

Of the many and various siege engines the general will make use according as he has opportunity. It is not my part to say that he must use battering rams or 'city-destroyers' or the *sambuca*,¹ or wheeled towers or covered sheds or catapults; all this depends upon the luck, the wealth, and the power of the combatants, and upon the skill of the workmen who accompany the army for the purpose

¹ An arrangement for lowering a bridge from a movable tower to the walls of a city. Its name was derived from its similarity to the triangular four-stringed musical instrument.

⁸ ὄντων μηχανημάτων vGH.

⁹ τοῖς κατὰ δύναμιν vGH.

¹⁰ Om. R.

¹¹ C: om. FvPGH.

¹² καὶ vGH.

¹³ ἢ ὑποτρόχους GHENP "alii codd. ut vid."

¹⁴ FGH: τοῖς Rigaltius "et alii codd. ut vid."

¹⁵ ἀρχιτεκτονικῶν PGH: ἀρχιτεκτονικῶν v.

¹⁶ ἐπινολαθ' F.

ONASANDER

4 ὀργανικὰς κατασκευὰς.¹ στρατηγοῦ δ' ἰδίας ἀγχινοίας ἔργον τοιόνδε² ἂν εἴη, εἰ³ βούλοιτο προσβάλλειν⁴ μηχανάς· καθ' ἓν μὲν ἀποχρήσθω μέρος τοῖς ἔργοις αὐτοῖς—οὐδὲ γὰρ ἄλλως⁵ ἂν τις εὐπορήσειεν ἐν⁶ κύκλῳ παντὶ τῷ τείχει περιστῆσαι μηχανάς,⁷ εἰ μὴ πάνυ μικρὰ πόλις εἴη—, εἰς πολλὰ δὲ τάγματα διελὼν τὸ στράτευμα κατὰ τὰ ἄλλα⁸ τοῦ τείχους μέρη κελευέτω τὰς κλίμακας προσφέρειν· οὕτως γὰρ εἰς ἀμηχανίαν οἱ πολιορκούμενοι πολλὴν ἐμπίπτουσιν· ἂν τε γὰρ ἀμελήσαντες τῶν ἄλλων μερῶν τοῦ τείχους ἐπὶ τὰς προσβολὰς⁹ τῶν μηχανῶν ἀμύνωσιν, ἅπαντες οἱ κατὰ τὰς κλίμακας μηδενὸς ἀποκωλύοντος ῥαδίως ἐπιβαίνουσι τῶν τειχῶν, ἂν τε διελόντες σφᾶς αὐτοὺς ἐπιβοηθήσωσι¹⁰ κατὰ μέρη, σφοδροτέρας ἐνεργείας γιγνομένης κατὰ τὰς ἐμβολὰς τῶν ὀργάνων οἱ καταλειφθέντες¹¹ οὐδὲ¹² μάχεσθαι τούτοις τολμήσαντες¹³ ἀδυνατήσουσι τὸ ἐπιφερόμενον
 6 κακὸν ἀποκρούεσθαι. διόπερ καθάπερ¹⁴ ἀγαθὸν παλαιστήν¹⁵ προδεικνύειν μὲν καὶ¹⁶ σκιάζειν¹⁷ εἰς πολλὰ μέρη δεῖ περισπῶντα καὶ ἐπισφάλλοντα¹⁸ δεῦρο κάκεισε¹⁹ πρὸς πολλὰ τοὺς ἀντιπάλους, ἐνὸς δὲ ζητεῖν ἐγκρατῶς λαβόμενον ἀνατρέψαι²⁰ τὸ πᾶν²¹ σῶμα τῆς πόλεως.

¹ F indicates a break here.

² τοιόνδ' Köchly.

³ εἴγε vGH.

⁴ προσβάλλειν GH A m² Rigaltius and mss. "tantum non omnes" (Schwebel).

⁵ FR: ἄλλος PFGH Rigaltius "ceteri codd. ut vid."

⁶ Köchly: εὐπορήσει ἐν F: εὐπορήσειεν GH: εὐπορήσειε v: ἀπορήσειε R.

⁷ περιστῆναι μηχαναῖς GHP "alii codd. ut vid.": περιθεῖναι μηχαναῖς A m²: περιθῆναι μηχαναῖς DENR.

THE GENERAL, xi.ii. 3 - 6

of building engines. The task of a general's peculiar skill, if he wishes to employ engines, is to use them at some one locality—for he would not have a sufficient supply of engines to place them in a circle completely about the wall unless the city were very small,— and, dividing his army into many parts, he should [station his engines at certain points and should] command his men to bring forward their ladders against the other parts of the wall, since in this manner the besieged are rendered helpless. For if the besieged disregard the other parts of the wall and only make a defence against the attacks of the engines, all the besiegers who attack with ladders will easily climb over the wall without opposition, but if the defenders divide their forces and send aid to each part as the battle grows more violent through the attack of these engines, those who are left and who do not venture to fight with them will be unable to repel the advancing menace. On this account, just as a good wrestler, the general must make feints and threats at many points, worrying and deceiving his opponents, here and there, at many places, striving, by securing a firm hold upon one part, to overturn the whole structure of the city.

⁸ Köchly (except that he read *τάλλα*): *καὶ κατὰ τὰ ἄλλα* F^c: *καὶ τὰ ἄλλα* PGH Rigaltius “*ceteri codd. ut vid.*”

⁹ *προβολὰς* FGHR.

¹⁰ *ἐπὶ τὴ βοηθήσῳσι* vGH.

¹¹ *καταληφθέντας* F.

¹² *ἴδε* vGH.

¹³ Supplied by Köchly, who suggests also *θαρροῦντες*.

¹⁴ *ὡς* v: om. PGH.

¹⁵ *παιλαιστῆν* H.

¹⁶ Om. P.

¹⁷ FCDGH: *σκευάζειν* v: *σκεδάσειν* Koraes.

¹⁸ *περισφάλλοντα* Koraes.

¹⁹ *κακεῖσαι* GH.

²⁰ FD: *ἀναστρέψαι* PGH Rigaltius Schwebel “*ceteri codd. ut vid.*”

²¹ FGH: om. v: *πάν τὸ* Koraes.

ONASANDER

δ'. [Πῶς χρῆ διατελεῖν ἐπείγοντα τὰ τῆς
πολιορκίας]¹

- 7 Εἰ δ' ἐν τάχει σπεύδοι² τις ἐξελεῖν φρούριον ἢ πόλιν ἢ χάρακα καὶ αὐτῷ κάμνοι ἢ δύναιμις³ μηδὲ μίαν ὥραν ἀποστήναι βουλομένῳ τῶν ἐρυμάτων, εἰς τάγματα διελὼν τὸ στράτευμα, ὅσ'⁴ ἂν ἰκανὰ εἶναι οἱ⁵ δοκῆ κατὰ τὴν ἀναλογίαν τοῦ⁶ πλήθους καὶ κατὰ τὸ μέγεθος τῆς πολιορκουμένης πόλεως, νυκτὸς ἀρξάμενος εὐθὺς τῷ μὲν πρώτῳ προσβαλλέτω⁷ τάγματι τῷ δευτέρῳ κελεύσας⁸ ἐφεδρεύειν καὶ ἐτοίμῳ⁹ εἶναι, τῷ δὲ τρίτῳ καὶ τετάρτῳ, καὶ εἰ τύχοι πέμπτον ὄν, παραγγελλέτω¹⁰ τρέπεσθαι
- 8 κατὰ κοῖτον· εἶτα, ὅταν τῷ πρώτῳ καταπειράσῃ¹¹ τινὰ χρόνον, τούτους μὲν ἀνακαλεσάμενος ἀποπεμπέτω κοιμησομένους, σημαινέτω δὲ τῷ δευτέρῳ προίεναι τοῦ χάρακος, ὁ δὲ τρίτος ταγματάρχης ἀναστήσας ἐν τούτῳ καθοπλιζέτω τὸ ὑφ' ἑαυτὸν
- 9 τάγμα· καὶ μετὰ¹² τοὺς δευτέρους τὴν ἴσην ὥραν τοῖς πρώτοις ἀγωνίζεσθαι¹³ ἄξει¹⁴ τὸ τρίτον, κοιμάσθω¹⁵ δὲ τὸ δεύτερον τάγμα,¹⁶ μετὰ τοῦτο δ' αὐτὸ¹⁷ τέταρτον, εἴθ' ἐξῆς τὸ πέμπτον, ἐν μέρει τῶν
- 10 στρατιωτῶν ἀναπαυομένων. ὁμοίως δ' ἐπισυναπτούσης τῆς ἡμέρας οἱ πρῶτοι τῇ νυκτὶ προσβαλόντες¹⁸ ἔωθεν πάλιν πρῶτοι¹⁹ προσαγόντων· εἴθ' ὥρας,²⁰ εἰ μὲν ἐξ εἴη τάγματα, δύο κινδυνεύσαντες, εἰ δὲ πέντε, δυσὶν²¹ ἔτι μικρὸν ἐπιθέντες, εἰ δὲ

¹ See note on title before § 2: "Quomodo oppugnatio acriter urgendo continuari possit" Rigaltius Schwebel.

² FGH: σπεύδει ν. ³ ἡ δύναμις αὐτῷ κάμνοι von Rohden.

⁴ Koraes, comparing Leo, *Tactica*, xv. 16: δτ' Ω.

⁵ ἰκανὰ εἰ | ναλοι F corr. B: om. οἱ vGH. ⁶ αὐτοῦ A m².

⁷ προσβαλλέτω vGH Rigaltius A m² "ceteri codd. ut vid."

(4) [*On ending Sieges by vigorous Action*]

If a general desire quickly to capture a fort or city or camp and his force grow weary, while he wishes not to spare one hour from attacking the defences, he should split his army into divisions, as many as he considers sufficient, according to the number of his men and the extent of the besieged city, and then he should attack immediately at nightfall with the first division, ordering the second to remain near in readiness, but the third and fourth and fifth, if there chance to be a fifth, he should order to sleep. Then when the first division has attacked for some time, he should recall it and send it to its quarters to sleep, but he should give the signal to the second division to march out from the camp; at this point the commander of the third division should arouse and arm his troops. After the second division has fought as long a time as the first, he will lead out his third division and order the second to rest; after this the fourth, then in order the fifth, while the soldiers in turn rest from fighting. Thus, at daybreak, those who attacked first at night should again attack first at dawn, remaining at the front two hours, if there are six divisions, but a little longer if five; three hours if four divisions, and four

⁸ κελύσαι F. ⁹ τὸ δεύτερον . . . ἔτοιμον von Rohden.
¹⁰ παραγγελέτω GH. ¹¹ κατὰ πείρας ἤ F.
¹² μετὰ τὸ vGH. ¹³ ἀγωνίσασθαι Koræes.
¹⁴ ἔξει F: τάξει von Rohden.
¹⁵ κοιμᾶσθαι vGH. ¹⁶ Om. FGH.
¹⁷ δ' αὐτὸ F: δὲ αὐτὸ vGH. ¹⁸ προσβάλλοντες vGH.
¹⁹ πρῶτοι πάλιν vGH (πρῶτοι GH): τῇ νυκτὶ . . . πρῶτοι
 om. R Camerarius.
²⁰ ὀρᾶς F. ²¹ δυοῖν v: δοιεῖν GH.

ONASANDER

- τέτταρα,¹ τρεῖς, εἰ δὲ τρία,² τέτταρας,³ ἀπίοντες ἀριστοποιεῖσθων,⁴ ἐξῆς δ' οἱ μετ' αὐτοὺς καὶ πάλιν οἱ μετὰ τούτους ἄχρι τῶν τελευταίων, ὥστε
- 11 κύκλον⁵ τινὰ περιάγεσθαι. τούτου γὰρ συμβαίνοντος ἀμφοτέρα ἂν γίγνοιτο· καὶ αἱ⁶ προσβολαὶ καὶ νύκτωρ καὶ μεθ' ἡμέραν ἀδιάλειπτοι προσαχθήσονται, καὶ οἱ προσβάλλοντες ἀκμήτες καὶ νεαροὶ τὰς ἀναπαύσεις ἐν μέρει ποιοῦμενοι
- 12 μαχοῦνται. τοὺς μέντοι πολιορκουμένους, μηδ' ἂν πάνυ πολλοὶ τυγχάνωσι,⁷ οἰέσθω τις τὸ αὐτὸ στρατήγημα ἀντεισοῖσσεσθαι.⁸ τὸ γὰρ κινδυνεῦον, οὐδ' ἂν ἐπιτρέπη τις, ὕπνω χαρίζεσθαι⁹ βούλεται· φόβῳ γὰρ τοῦ δεινοῦ, παρ' ὃν ἀναπαύεται χρόνον, ὡς¹⁰ ἄλωσομένης τῆς¹¹ πόλεως ἐγρήγορε· καὶ τὸ πολιορκούμενον, κἂν¹² ὀλίγον ἢ τὸ πολιορκοῦν αὐτό, πασσυδι¹³ προσαμύνει, καὶ πᾶν ὅσον ἐντειχιδίον ἐστί κεκίνηται, ὅτι καὶ τὸ μέλλον φοβερώτερον, ὡς, εἰ¹⁴ παρὰ μικρὸν ἀμελήσαιεν, ἀπολούμενοι πάντες. ὅθεν δὴ¹⁵ πᾶσα ἀνάγκη τρυχομένους αὐτοὺς καὶ μηδὲ μίαν ὥραν ἀνάπαυλαν ἴσχοντας, ἀλλὰ καὶ¹⁶ ἀγρυπνίαις¹⁷ καὶ πόνοις κάμνοντας, εἶτα καὶ πρὸς τὰ¹⁸ μέλλοντα τεταλαιπωρηκότας¹⁹ ἀσθενέστερον τοῖς σφετέροις προσαμύνει ἢ τοὺς δεησομένους καὶ παραδώσοντας τὴν πόλιν ἐκπέμπειν.

¹ τέτρα GH. ² FGH: τρεῖς v. ³ τέτταρες R.

⁴ ἀριστοποιεῖσθωσαν vGH.

⁵ FCR: κύκλω vGH (κύκλω GH): κύκλω τινι Schwebel Koraes. ⁶ FGH: om. v. ⁷ τυγχάνουσι P: -σιν GH.

⁸ τῷ αὐτῷ στρατηγήματι ἀντιτάσσεσθαι vGHA m².

THE GENERAL, XLII. 10 – 13

hours if three divisions ; on their return they should receive their rations in order, the first division, then the second, and so on to the last, like the revolution of a wheel. With this plan, there are two results : unceasing attacks by night and day, while the attackers, taking their turns at rest, will fight freshly and vigorously. But no one should believe that the besieged, even if very numerous, could use this same stratagem, for in danger no one would wish to enjoy sleep even if it were permitted, since from fear of peril, during the time at which one is resting, he lies sleepless, as though the city were on the point of capture. The besieged, moreover, even if their assailants are few, defend themselves with all their strength, and everything within the walls of the city is in a state of excitement, in even greater terror of the future, as though if one minute detail were overlooked, they would all be lost. On this account there is every reason why men wearied, without an hour's rest, tired by guard-duty and labour, and fearful for the future, should defend themselves more weakly, or should send out messengers to discuss the surrender of the city.

⁹ Om. τὸ γὰρ . . . χαρίζεσθαι H.

¹⁰ Om. F. ¹¹ Om. vGH.

¹² καὶ PA m². ¹³ πάση σπουδῇ v (πάση σπουδῇ GH).

¹⁴ ὡσεὶ R. ¹⁵ δεῖ PGH Rigaltius "alii codd. ut vid."

¹⁶ καὶ γ' F. ¹⁷ ἀγρυπνοῖαι GH.

¹⁸ Köchly: εἰ καὶ τὰ πρὸς τὰ F: ἢ καὶ πρὸς τὰ vGH (εἶτα πρὸς τὰ B).

¹⁹ τεταλεπωρηκότας G: -κοτάς H.

ONASANDER

ε'. [Πῶς χρῆ τὸν στρατηγὸν ἀναπαύεσθαι]¹

- 14 Αὐτὸς οὖν ὁ στρατηγός, ἴσως φήσει τις,² ἐξ ἀδάμαντος ἢ σιδήρου κεχάλκευται μόνος ἄγρυπνος ἔστῳς³ ἐπὶ τοῖς αὐτοῖς ἔργοις⁴; οὐ δῆτα· ἀλλὰ παρ' ὃν ἀναπαύεται χρόνον—οὗτος⁵ δ' ὀλίγος⁶ ἔστω καὶ σύντομος⁷—, ἕνα τῶν⁸ ἐν δόξῃ πιστοτάτων καὶ ἀνδρειοτάτων ἡγεμόνα⁹ τῶν καὶ τὰ δεύτερα τῆς στρατηγικῆς ἀρχῆς ἐχόντων ἐπιστησάτω τοῖς ἔργοις.¹⁰

Σ'. [Πῶς τὰ δοκοῦντα τῆς πόλεως μέρη ἀνάλωτα εἶναι πολλάκις εὐάλωτα γίνεται]¹¹

- 15 Ἐνίστε δὲ τὰ δοκοῦντα μέρη πόλεως¹² εἶναι κρημνώδη καὶ πέτραις ἀποτόμοις ὠχυρωμένα¹³ τῶν διὰ χειρὸς ἀνεστηκότων τειχῶν¹⁴ ἔδωκε τοῖς πολιορκουσίῳ ἀφορμὰς μείζονας¹⁵ εἰς τὸ νικᾶν· εἴωθεν γάρ πως ὡς τὰ πολλὰ τὰ τοιαῦτα¹⁶ τῶν πόλεων, ὅσα φύσει πιστεύεται τὸ ἐρυμνόν, ἀφυλακτεῖσθαι καὶ ἥκιστα φροντίδι παραγρυπνεῖσθαι
16 στρατιωτῶν.¹⁷ ἔνθα στρατηγὸς ἀγαθὸς ἐνόησεν ὁ δεῖ¹⁸ ποιῆσαι, καί τινας τῶν εὐτολμοτάτων¹⁹ παρακαλέσας ἐπαγγελίαις καὶ τιμαῖς ὀλίγους,²⁰ οἷς

¹ See note on title before § 2: "Quo pacto imperator quiescere a laboribus aliquando possit" Rigaltius Schwebel.

² τίς corr. τινές (?) G.

³ ἔστω vGH.

⁴ καὶ μόνος ἄγρυπνος ἔσται ἐπὶ τοσοῖτοις ἔργοις Koraes.

⁵ οὕτως F.

⁶ ὁ λόγος RA m².

⁷ οὐ . . . σύντομος, om. Camerarius.

⁸ ἐν αὐτῷ· F: ἕνα τῶν αὐτῶ Kóchly suggests.

⁹ ἡγεμόνων vGH.

¹⁰ τοῖς ἔργοις ἐνίστε δὲ κτλ. F.

(5) [*How the General should rest*]

"But has the general himself, then," some one may perhaps say, "been made of adamant or iron to have remained alone without sleep throughout all these deeds?" Certainly not; but during the time that he sleeps—and this must be little and cut short—he should hand over the command of the army to one of his most trusted and courageous officers, who is also second only to himself in military rank.

(6) [*Parts of a City seemingly most impregnable are often easy to capture*]

Sometimes those parts of a city that seem precipitous and are fortified by the sheer rocky cliffs, offer the besiegers greater chances for victory than do fortresses erected by human hands, for those places whose fortification relies upon natural strength are wont to be less carefully watched and guarded by soldiers. Then the wise general considers what he must do, and encouraging a few of his bravest soldiers with promise of reward, men who are best

¹¹ See note on title before § 2: "Loca quae obsessi inaccessa existant obsidentibus saepenumero prodesse," Rigaltius Schwebel. ¹² τῆς πόλεως vGH.

¹³ ὀχυρώτερα vGH (ὀχ- GH).

¹⁴ F indicates a break here.

¹⁵ μείζους vGH Köchly.

¹⁶ FC: ποιούντα ENPGH Rigaltius "ceteri codd. ut vid."

¹⁷ παραγνυπνεῖσθαι στρατειωτῶν H.

¹⁸ FENR: δὴ GH Rigaltius "ceteri codd. ut vid."

¹⁹ εὐτολμωτάτων GH.

²⁰ FGH (ὀλ- GH): ὀλίγαις ENRA m² Camerarius.

ONASANDER

ῥᾶον ἀναβαίνειν¹ εἴτε δι' αὐτῆς τῆς δυσχωρίας,²
εἴτε διὰ κλιμάκων, ἐκράτησε τῆς πράξεως.³
ὑποκαταβάντες⁴ γὰρ ἐντὸς τείχους⁵ ἦ πυλῖδα
διέκοψαν ἢ πύλην ἀνέωξαν.

ζ'. [Περὶ τῆς ἀπὸ τῶν σαλπύγγων ὠφελείας]⁶

- 17 Μέγα δ' ἂν ὀνήσειε καὶ τι⁷ τοιόνδε συνεπι-
νοηθέν, εἰ καὶ σαλπικτὰς οἱ φθάσαντες ἐπι-
βῆναι τοῦ τείχους ἀνμήσαιεν.⁸ ἀκουσθεῖσα γὰρ
πολεμία σάλπιγξ ἀπὸ τειχῶν ἐν νυκτὶ πολλὴν
ἔκπληξιν ἐπιφέρει τοῖς πολιορκουμένοις ὡς ἦδη
κατὰ κράτος ἐαλωκόσιν, ὥστε τὰς πύλας καὶ τὰς
ἐπάλξεις ἀπολιπόντας φεύγειν· ὅθεν δήπου συμ-
βαίνει γίνεσθαι τοῖς ἔξω στρατιώταις ῥαδίαν
τὴν τε τῶν πυλῶν ἐκκοπήν καὶ τὴν ἐπὶ τὰ τεῖχη
διὰ τῶν κλιμάκων ἀνάβασιν, οὐδενὸς ἔτι τῶν
πολεμίων ἀπείργοντος· οὕτως που δυνατὸν ἐνὶ
καὶ ἀνόπλῳ σαλπικτῇ⁹ πόλιν ἀλῶναι.

η'. [Τί χρῆ ποιεῖν τὸν στρατηγὸν μετὰ τὸ
ἐλεῖν τὴν πόλιν]¹⁰

- 18 Εἰ δὲ δὴ τινα ἀκμάζουσιν ἔτι¹¹ πλήθει τε καὶ
δυνάμει πόλιν ἐρρωμένως¹² ἐλὼν εἰς φόβον ἢ
ὑπόνοιαν ἦκοι, μὴ ποτε κατὰ τάγματα καὶ

¹ FC: ἄμα βαίνειν ENPGH Rigaltius A m².

² F Leo, *Tactica*, xv. 20: διὰ τινος βίας ἀναβάσεως (but a little later Leo uses the expression διὰ τῆς δυσχερείας ἐκείνης):
δυσχερείας vGH: δυσχερίας A m².

³ Köchly suggests πάσης πόλεως.

⁴ FGH: ὑποβάντες v.

⁵ FGH: τοῦ τείχους v.

THE GENERAL, XLII. 16 - 18

able to climb up by using either the natural unevenness of the ground or else ladders, he accomplishes his attempt; for descending stealthily within the walls they break down a postern or open a gate.

(7) [*The Advantage of Trumpets*]

Some such device as this would be of great assistance—if those who have succeeded in mounting the walls draw up trumpets after them. For a hostile trumpet heard at night from the walls brings great terror to the besieged, as if they had already been overcome by force, so that abandoning the gates and fortifications they flee. The result is that breaking down the gates and mounting the walls by ladders is easily accomplished by the soldiers on the outside since no one of the enemy resists any longer. Thus in some such way it is possible that one trumpeter, even without arms, can capture a city.

(8) [*Conduct of a General after the Capture of a City*]

If the general capture by force some city, flourishing in power and in the number of its citizens, and if he fear or suspect that the inhabitants advancing

⁶ See note on title before § 2: "Quid valeat tubicinis opera in expugnatione" Rigaltius Schwebel.

⁷ FGH: καί τοι ν.

⁸ ἀνιμήσαιεν corr. to καθιμήσαιεν (?) by early, perhaps contemporary, hand in F. ⁹ σαλπικτή GH.

¹⁰ See note on title before § 2: "Quid debeat agere imperator in urbem expugnatam invadendo" Rigaltius Schwebel. A break here is indicated in GH.

¹¹ ἐπι ν (ἐπι GH)

¹² ἐρρωμένην F.

ONASANDER

συστροφὰς ὑπαντιάζοντες ἀμύνωνται¹ τοὺς² ἐπι-
 εισπίπτοντας³ ἢ τὰ μετέωρα καταλαμβάνομενοι⁴
 καὶ τὰ ἄκρα τῆς πόλεως ἔνθεν ἀντεπίοιεν⁵ ἐπὶ
 πολὺ κακώσαντες⁶ τοὺς πολεμίους, κηρυττέτω
 19 τοὺς ἀνόπλους μὴ κτεῖναι. ἕως⁷ γὰρ ἕκαστος
 ἐλπίζει ληφθεὶς τεθνήξεσθαι, βούλεται φθάνειν
 δράσας καὶ πάσχων ἀλλὰ τι⁸ καὶ δρᾶν, πολλοὶ
 τε ἤδη πολεμίους εἰσκεχυμένους ἐξήλασαν ἢ καὶ
 μὴ⁹ δυνηθέντες εἰς ἀκρόπολιν ἐρυμνὴν κατειλή-
 θησαν,¹⁰ ἔνθεν αὐθις εἰς πόνον¹¹ καὶ τάλαιπωρίαν
 κατέστησαν¹² τοὺς πολεμίους, ὥστε δευτέραν ἐπ-
 αναιρεῖσθαι πολιορκίαν . . .¹³ ἢ καὶ πολυχρονιω-
 τέραν, ἔστιν δ' ὅτε καὶ ἐπαλγεστέραν μετὰ πολλῆς
 20 πείρας κακῶν. εἰ δὲ διαβοηθεῖη τόδε¹⁴ τὸ κή-
 ρυγμα, τάχα μὲν καὶ πάντες, ὡς δὲ πρόδηλον
 εἰπεῖν, οἳ γε πλείους τὰ ὄπλα ρίψουσι· τῶν τε
 γὰρ βουλομένων δι' ὀργῆς¹⁵ ἕκαστος εἰς ἄμυναν
 ἵεναὶ δεδιὼς τὸν πέλας, μὴ ποτε οὐχ ἑαυτῷ¹⁶
 ταυτὰ¹⁷ φρονῆ,¹⁸ ρίπτειν ἀναγκασθήσεται, ὥστε,
 κἂν πάντες βούλωνται¹⁹ τὰ ὄπλα φυλάττειν, διὰ
 τὴν πρὸς ἀλλήλους ὑπόνοιαν αὐτὸν ἕκαστον δεδιότα,
 μὴ μόνος ὀπλισμένος ληφθῆ,²⁰ σπεύδειν ἀποτι-

¹ ἀμύνοντο vGH: ἀμύνοιτο A m². ² τὰς GH: τοῖς A m².

³ ἐπιπίπτοντας vGH. ⁴ καταλαβόμενοι Koraes.

⁵ CGH (B): ἀντ' ἐπίοιεν F: ἀντεπίνοιεν P Rigaltius "alii codd. ut vid.": ἀντεπιτείνοιεν R.

⁶ κακώσαντες v (κακῶσαντες GH).

⁷ Köchly: ὡς F: ὁ ENGH Rigaltius "alii codd. ut vid.":
 δ Schwebel Koraes.

⁸ ἀλλό τι G: ἄλλο τι HA m²: ἄλλοτι Rigaltius "ceteri codd. ut vid.": ἄλλο τι Koraes.

⁹ Köchly: ἢ μὴ vGH: καὶ μὴ (om. ἢ) F.

¹⁰ FC: κατηλείθησαν GH: κατηλίθησαν ENR: κατηλίθησαν P Rigaltius "alii codd. ut vid."

THE GENERAL, XLII. 18 - 20

in companies and crowds may defend themselves against the invaders, or that seizing the heights and the citadel of the town they may advance from there and cause great loss to their opponents, he should command his own soldiers not to slay unarmed men of the enemy. For so long as every man expects to be killed after capture, he wishes first to do some deed of bravery, and even though he suffer, yet to accomplish something, and many inhabitants of towns have driven out enemies even when introduced into the town, or, failing in this, have crowded into the fortified citadel from which they have caused great labour and loss to their adversaries, who must enter into a second . . . and longer siege, one that is sometimes more distressing and attended by great hardships. But if the above-mentioned command should be published, quickly all the inhabitants, or, needless to say, at least the majority, would throw down their arms. For every one who through anger wishes to defend himself, will be compelled to lay down his arms for fear that his neighbour may not be of the same mind, so that even if all should wish to keep their weapons, on account of this suspicion of one another, each one fearing that he alone may be taken with arms on his person,

¹¹ πόνον A m².

¹² Koraes: κατεστήσαντο Ω.

¹³ Schwebel noted the lacuna here: και om. K. Koraes suggested that η και be deleted, Köchly suggests οὐχ ἦτρονα.

¹⁴ Om. vGH.

¹⁵ εἰς RA m² for δι ὀργῆς.

¹⁶ αὐτῶ v: αὐτῶ GH (ἐαυτῶ F).

¹⁷ ταῦτα Fv: ταυτὰ C: τ' αὐτὰ GH.

¹⁸ Schwebel: φρονεῖ FP "omnes codd. ut vid." (φρονεῖ GH).

¹⁹ βούλονται GH. ²⁰ ληφθῆ F: λειφθείη vGH.

ONASANDER

θέμενον¹ — οἱ γὰρ ὀξεῖς² καιροὶ τὴν³ κοινήν⁴ γνώμην φανεράν οὐκ ἐώσι⁵ γίνεσθαι —, οἳ τε ἔτοιμοι πρὸς τὸ σῶζεσθαι, μέχρι μὲν οὐδὲν εἰς ἐλπίδα κεκήρυκται σωτηρίας, εἰ καὶ⁶ μὴ γνώμη, ἀλλ'⁷ ἀνάγκη τὸ ἐπιὸν ἀμύνονται κακόν, ἐπειδὴν δὲ μικρὰν ἐλπίδα τοῦ σῶζεσθαι λάβωσιν, ἰκέται τὸ⁸ λοιπὸν ἀντὶ πολεμίων ὑπαντῶσιν.

21 οὕτως τε ὁ μὲν κηρύξας καὶ τοὺς τὰ ὄπλα φυλάττειν βουλομένους ῥίπτειν αὐτὰ ἀναγκάζει.⁹ στρατιωτῶν δὲ θάνατος ἐν μὲν³ μάχαις εὐπαραμύθητος¹⁰ —δοκεῖ γὰρ τοῦ νικᾶν ἔνεκεν γεγενῆναι —, ἐν δὲ νίκαις καὶ καταλήψεσι πόλεων τοῖς νικῶσιν οἴκτιστος, ἀφροσύνης τε¹¹ μᾶλλον¹² ἢ ἀνδρίας¹³ μαρτυρίον¹⁴. εἰ μέντοι¹⁵ μνησικακῶς ἔχοι¹⁶ τοῖς ἡττημένοις¹⁷ στρατηγός, μὴ παρὰ τούτοις¹⁸ οἰεσθῶν τι¹⁹ φέρεσθαι βλάβος,²⁰ ὅτι τοὺς²¹ ἐντυγχάνοντας μὴ εὐθύς κτενοῦσι.²² σχολῇ γὰρ βουλευσεται μετὰ τοῦ ἀκινδύνου τὴν ἄμυναν ἀνανταγώνιστον²³ ἔχων, τί²⁴ χρὴ διαθεῖναι²⁵ τοὺς ἐαλωκότας.

¹ Köchly von Rohden: σπευδειν ἀποτιθέμενοι F: σπεύδειν ἀποτίθεσθαι vGH.

² "οἱ γὰρ ὀξεῖς etc.] desunt in LR" Rigaltius. He means probably οἱ . . . σῶζεσθαι, words which he brackets in the text. ³ Om. vGH. ⁴ καινήν vGH: καὶ τὴν Koraes.

⁵ οὐκ ἐώσι (ἐώσιν GH) φανεράν vGH.

⁶ κἂν v: κἂν GH for εἰ καὶ.

⁷ Added by Köchly.

⁸ FGH: om. v.

⁹ Köchly: τοὺς ῥίπτειν αὐτὰ βουλομένους φυλάττειν ἀναγκάζει F: τοὺς τὰ ὄπλα φυλάττειν βουλομένους ῥίπτειν παρασκευάζει vGH (except βουλομένους GH).

¹⁰ ἀπαραμύθητος vGH.

¹¹ Om. KR Koraes.

¹² μάλιστ' R.

¹³ ἀνδρείας GH.

hastens to give up his weapons. For a sudden emergency does not give time for the common opinion to become known. And those who are ready to protect their own lives so long as no hope of safety has been announced, strive to avert the imminent danger, if not as they wish, then as they must, but when they perceive a small hope of safety, they become suppliants instead of enemies. Thus this proclamation compels even those who wish to keep their arms to throw them down. The death of soldiers in battle admits of easy consolation, for it seems to have been the price of victory, but in victory and the occupation of cities it is a matter of sorrow to the conquerors, as an evidence of thoughtlessness rather than bravery. If, however, the general is revengeful toward the conquered, he should not think that no harm is done them if his men do not slay on the spot all whom they meet, since at his leisure he will be able to plan in perfect safety his uncontested vengeance and the fate that the conquered must undergo.

¹⁴ Koraes: μαρτυρεῖ F: μαρτυρεῖν vGH.

¹⁵ μέν τοι F: γάρ πως v: γάρ τοι GH.

¹⁷ ἡττωμένοις R. ¹⁸ τοῦτο vGH.

²⁰ βλάβως GH.

²² κτενοῦσιν Kic^hly: κτείνουσιν vGH.

²³ ἀμύν ἀνανταγώνιστον F (the correction is probably by the first hand, in Rostagno's opinion): ἀμυναν ἀνανταγώνιστον CP: ἀμυναν ἀνταγώνιστον GH Rigaltius "ceteri codd. ut vid."

²⁴ ἔχοντι vPA m² GH: ἔχων τι F.

²⁵ διαθήναι H: διαθῆναι (?) corr. το διαθεῖναι G.

¹⁶ ἔχει vGH.

¹⁹ τι F.

²¹ τοὺς μὴ F.

ONASANDER

θ'. [Τὸν λιμῶ μέλλοντα πόλιν αἰρήσειν τοὺς κατὰ τὴν χώραν ἀσθενεῖς εἰς αὐτὴν χρῆ πέμπειν]¹

- 23 Εἰ δὲ τὴν κατὰ κράτος ἀπεγνωκῶς ἐκπόρθησιν εἰς χρόνιον καταβαίνοι πολιορκίαν οἰόμενος λιμῶ πιέσας² τὴν πόλιν αἰρήσειν, ἃ τινὰ ἂν ἐπὶ τῆς χώρας ἔτι³ καταλάβῃ σώματα, τούτων τὰ μὲν ἔρρωμένα καὶ ἀκμάζοντα ταῖς ἡλικίαις εἰς ἄμυναν πολέμου λαβῶν, ὃ τι περ ἂν αὐτῷ δόξῃ,⁴ διαθέσθω, γύναια δὲ καὶ παιδάρια⁵ καὶ ἀσθενεῖς ἀνθρώπους καὶ γεγηρακότας ἐκῶν⁶ εἰς τὴν πόλιν ἀποπεμπέτω· ταῦτα γὰρ ἄχρηστα μὲν εἰς τὰς πράξεις ἔσται,⁷ τὰς δὲ παρεσκευασμένας⁸ τοῖς⁹ ἔνδον τροφὰς¹⁰ θᾶπτον συναναλώσει,¹¹ καὶ πολεμίων μᾶλλον ἢ φιλιῶν ἐφέξει¹² τρόπον.¹³

ι'. [Ὅποιον εἶναι χρῆ τὸν στρατηγὸν μετὰ τὴν νίκην]¹⁴

- 24 Εἰ δέ τω¹⁵ πάντα κατὰ δαίμονα καὶ νοῦν χωρήσειεν, ὥστε τοῖς ὅλοις ἐπιθεῖναι τοῦ πολέμου πράγμασι τέλος, ἔστω μὴ βαρὺς ἐπὶ ταῖς εὐπραγίαις, ἀλλ' εὐφορτος,¹⁶ μηδὲ τύφον ἀπηνῆ περιφέρων, ἀλλ' εὐμένειαν προσφιλή ἔχων· ὃ¹⁷ μὲν¹⁸

¹ See note on title before § 2: "Imbelles captivos remittendos, si fame urbs premenda sit" Rigaltius Schwebel.

² Köchly: λιμῶ πιέσαι F: om. πιέσας vGH.

³ Om. vGH.

⁴ δόξει GH.

⁵ καὶ παιδάρια FPGH: om. v.

⁶ ἐλών Koraes.

⁷ Added by Köchly.

⁸ εἰς δὲ τὰς παρεσκευὰς μόνας F: τὰς παρεσκευασμένας: τὰς παρεσκευασμένας GH Koraes.

⁹ τοῖς δὲ vGH.

¹⁰ τὰς τροφὰς GH: στροφὰς P Rigaltius "alii codd. ut vid."

(9) [*Necessity of sending Women and Children into a City to capture it by Famine*]

If the general should despair of sacking a city by force and should settle down to a prolonged siege, believing that he will capture the city if he has pressed it hard by famine, he should take prisoners whatever persons are still in the country. Of these, to the men in the prime of life he should assign work on the defences such as seems best to him, but the women and children and feeble men and old people he should send of his own accord into the city. These will be useless in action but will consume more quickly the supplies of the besieged and will serve the purpose of enemies rather than friends.

(10) [*Conduct of the General after Victory*]

If the war should chance to turn out in everything according to the general's desire, so as to put a complete end to the enemy's activity, he should not be overweening in his good fortune, but gracious; he should not show violent stupidity but kindly good-

¹¹ σιναναλώσει θάπτον vGH.

¹² φίλων εξει vGH (εξει GH).

¹³ τόπον Scaliger.

¹⁴ See note on title before § 2: "Qualis esse debeat imperator parva victoria" Rigaltius Schwebel.

¹⁵ αὐτῷ Scaliger.

¹⁶ Köchly: ἀλλάφορτος F: ἀλλ'ἀφυρτος G: ἀλλὰφυρτος H: ἀλλ' ἀφυρτος v: ἀλλ' ἀφορτος Koræes.

¹⁷ προσφιλή· ἐκείνος von Rohden.

¹⁸ Köchly: ἐχων· ἀμὲν F: ἐκείνα (ἐκείνα GH) μὲν vGH.

ONASANDER

γὰρ φθόνον ἐγέννησε,¹ αὐτῆ² δὲ ζῆλον ἐπεσπάσατο.³
 25 φθόνος μὲν οὖν ἔστιν ὀδύνη τῶν πρὸς τοὺς⁴ πέλας
 ἀγαθῶν, ζῆλος δὲ μίμησις τῶν παρ' ἄλλοις⁵
 καλῶν, τοσοῦτόν τε⁶ διενήνοχεν ἀλλήλων, ὥστε
 τὸ μὲν φθονεῖν⁷ εὐχὴν εἶναι τοῦ καὶ παρ' ἄλλω τι
 καλὸν μὴ εἶναι, τὸ δὲ ζηλοῦν ἐπιθυμίαν τῆς τῶν
 26 ἴσων κτήσεως. ἀνὴρ οὖν ἀγαθὸς οὐ μόνον
 πατρίδος τε καὶ στρατιωτικοῦ πλήθους ἄριστος
 ἡγεμῶν, ἀλλὰ καὶ τῆς περὶ αὐτὸν εἰς αἰεὶ⁸ εὐδοξίας
 ἀκινδύνου⁹ οὐκ ἀνόητος στρατηγός.¹⁰

¹ ἐγέννησαν v: ἐγένησαν PGH: ἐγέννησεν Köchly von Rohden.

² Köchly (without a note): ταῦτα FGH Rigaltius Schwebel Koraes v (apparently).

³ ἐνεσπάσατο G Rigaltius "alii codd. ut vid.": ἐνεσπάστατο H: ἐσπάσατο RA m²: ἐσπάσαντο K: ἐπεσπάσαντο Koraes.

THE GENERAL, vLII. 24 - 26

will ; for the former excites envy, the latter causes emulation. Now envy is a pain of mind that successful men cause their neighbours, but emulation is imitation of the good qualities of others ; such is the difference between them that envy is the desire that another may not have good fortune, but emulation is the desire to equal the possessions of another. A good man, then, will be not only a brave defender of his fatherland and a competent leader of an army but also for the permanent protection of his own reputation will be a sagacious strategist.

⁴ *παρὰ τοῖς Κοραεῖς.*

⁵ FGH: ἀλλήλοις P Rigaltius "ceteri codd. ut vid."

⁶ *τσοῦτον δέ τε* vGHI: *τσοῦτον δέ τοι* RA m².

⁷ *φθονήν* P.

⁸ *ἀεὶ* GH Kschly.

⁹ Deleted by von Rohde

¹⁰ Subscription *ὄνασάνδρου στρατηγικός* F (see Introd.).

INDEX

The numbers refer to pages.

- Abderites, 79
Abydos, 147
Achaea, 95
Admonitions, work on, 191
Aegina, 105
Aelian, 205
Aeneas, 165, 201, 205
Aeolis, 125
Alexander (of Epirus), 201
Amasis, 187
ancestors, effects of, on the
 general, 385
animals, pedigrees of, 385
Apollodorus, 207
Apollonia Pontica, 105
Arcadian, 139
Ares, 125
Argives, 67, 91
Argos, 67
Aristagoras, 171
armour, 383, 469, 485
Arrian, 205
arsenal, 65
Artabazus, 169
Artemis, 129
astragals, 163, 165, 215
astrology, relation of, to extispicy,
 431
Astyanax, 173
Athena, 125
Athenian(s), 41, 43, 69
Athenodorus, 127, 129
Athens, 41
Augustus Caesar, 369
- Barca, 85, 187
baton, 119
bazaars, 153
bees, 187, 219
bells, 143
- bird-lime, 183
bladder, 161
bolt-pins, 93, 95, 97, 99, 103, 105
Bosporus, 43
burial of the fallen, 491
- Cadmea, 131, 173
Caesar, Augustus, 369
cap, felt, 69
catapults, 509
caulking of ships, 65
censorship of letters, 55
Chalcedonians, 71, 73
Chalcidians, 39
Chalcis, 39
Chares, 69
Charidemus, 125, 127, 129
chariots, 249, 291
cheerfulness, importance of, 439
children, advisable for the general
 to have, 379
Chios, 65, 91
Cineas, 201
circles, area of, 423
city-destroyers, 509
Clazomenae, 147
Clearchus, 201
clock, 117, 209
cocks, cautery of, 121
Corcyra, 69
Corcyreans, 71
cows, 143
crescent formation, 455, 457
Cretan(s), 303, 305
crown, importer honoured with,
 57
Cyrene, 85
Cyzicus, 71
- Datamas, 197

INDEX

- decorations, military, 485
 Demeter, 41
 deserters, 421, 427
 dice-playing, 43
 Dionysius, 61 171, 197
 Dionysus, 91
 Dioscuri, 125, 129
 disease, 407
 dogs, 111, 113, 115, 121, 131, 173.
 189, 217, 487
- elephants, 249, 291, 293
 Eleusis, 4
 embassies, public, 55, 61
 Encampments, work on, 107
 Enyalios, 125
 Ephesus, 157
 Epirus, 173, 201, 217
 Eretria, 39
 Euphrates, 141
 Euripus, 39
 exercise, need of, 409
 exiles, 53, 59
 extispicy, relation of, to astrology,
 431
- factions: see party-struggles
 family, important for the general
 383, 385
 famine, 525
 Fate, 429
 fatigue, effect of, 401
 fear, a false prophet, 507
 festivals, 53, 91, 113, 140, 151,
 211, 491
 Finance, work on, 75
 fire-extinguishers, 183, 207
 fire-pot, 39
 fire-signals: see signals
 fires to deceive the enemy, 419
 foraging, 415
 Fortune, 371, 373, 393
 frankincense, 133
 Fronto, 201
 funerals, 53
- Glus, 175
 gods, 391, 495
 gourds, 151
 Greek(s), 29, 131, 205, 279
 gymnasia, superintendents of, 375
- Hellespont, 147
 Heraclea Pontica, 69, 73
 Heracleides, 171
- Heracles, 129
 Hermeas, 201
 Hermes, 129
 Ilmera, 61
 Histiaeus, 171
 holidays: see festivals
 Homer, 201, 377
 honours, awarding of, 485
 hostages, 61
 hundreds, 69
 huntsmen and dogs, 487
- idleness, prevention of, 407
 Ilium, 125, 127, 169
 Imbrian, Athenodorus the, 127
 inns, 55
 Ionia, 97
 Iphlades, 147
 Iphicrates, 129
 Italy, 371
- Lacedaemon, 69
 Lacedaemonians, 33
 Laconian(s), 141, 303, 305, 333
 ladders, 65, 183, 185, 191, 511,
 519
 lamps and lanterns, 57, 63, 115,
 137
 Lampsacus, 173
 leeches, 71
 Leptines, 61
 Lesbos, 173
 Leuco, 43
 lightning, representation of, in
 art, 181
 lights: see lamps
 Locrian maidens, 169
 lot, use of, 37
 lyre, strings of, 411
- Macedonian(s), 247, 271, 279, 303,
 305
 market-place, 31, 33, 37, 57, 93,
 107, 133, 149, 155
 marshy land to be avoided for
 camps, 407
 meals, 435
 medical equipment, 399
 Megara, 43
 Megarian(s), 41, 43
 mercenaries, 67, 71, 73, 75, 95,
 99, 119, 125, 127, 147
 merchants, 383, 403
 messages, secret, 155 ff., 161 ff.
 messengers, 435

INDEX

- Miletus, 171**
Military Preparations, work on,
 47, 49, 105, 199
 mines, 179, 185, 187, 219
 Moon, 129
 musical instruments, 411
 musical intervals, 411
 Mytilene, 173
- Naxos, 115**
 needle for mats, 97
 nets, 65, 191, 195
 Nicocles, 115
- omens, 429, 431
 Onesander (*sic*), 207
 Oreus, 125
 osiers, 153
- Paeon, 139**
 palisades, 423, 505
 Pallas, 125
 panics, 139, 141, 143, 397
 papyrus, 159, 167, 217
 Parians, 147
 Parium, 147
 parleys, 419
 party-struggles, 31, 59, 67, 69,
 91, 93, 113
 party-walls, 33
 passports, 55
 Patro, 207
 pedigrees of animals, 385
 Peisistratus, 41
 Peloponnesian (word), 139
 pent-house, 179, 181
 Persian(s), 279, 303, 305
 physicians, 381, 473
 pilots, simile from, 479, 481
 pincers, 95
 pipe, stops of, 411
 pitch, 183, 207
 Plataeans, 33
 Plots, work on, 65
 poison, 205
 Polybius, 201, 205
 portcullis, 193, 221, 223
 Poseidon, 129
 Potidaea, 169, 171
 priests, choice of, 375
 prisoners, treatment of, 441, 489,
 525
 proclamations, 53, 57, 59
 purification of army, 393
 Pyrrhus, 201
- Pytho, 147**
 races, torch and horse, 89
 ramp, 113, 115
 rams, 177, 509
 reinforcements, 461
 reserves, 459
 rest, how the general should, 517
 revolution: see party-struggles
 rewards, 57
 Rhodian, Temenus the, 99
 Romans, 369, 371, 373
 rush-mats, 97
- sacrifices, 395, 429, 431, 485
 sacrilege, 495
 sails, 65
 sambuca, 509
 sandals, 157, 215
 sawing through the bar, 163
 Scythian(s), 249, 279
 sheds, covered, 509
 ship-houses, 65
 ships, overhauling of, 393
 shouting in battle, 471
 Sicilians, 279
 Sicyonians, 153
 siege engines, 509
 signals, 39, 45, 47, 75, 87, 101,
 111, 139, 203, 205, 467
 Sinope, 197
 slings, 445, 449
 smuggling, 149, 211
 soothsayers, 53, 395, 429
 spies, 113, 417
 sponge, 103, 161
 staff of the general, 389
 stars, knowledge of the, 431, 499,
 501
 Stratocles, 201
 sulphur, 183, 207
 Sun, 129
 surrendered cities, treatment of,
 497
 sweeps, 195
 Syracuse, 61
- tablet, boxwood, 163
 Tarentine, 251, 291
 tattooing, 171
 Temenus, 99, 101
 Teos, 97
 thank-offerings, 485
 theatre, 31, 37, 107
 Thebas, 33, 35

INDEX

- Thebes, 131, 173
Thessalian(s), 173, 201, 217, 277
Thrace, 141
Thracians, 279
tile-roofs, 35
Timoxenus, 169
topography, 431
torches, 47, 63, 123, 205
torch-race, 89
tow, 183
towers, 509
traders, 383
traitors, treatment of, 490, 501
Triballi, 79
tripods, 33
trumpets, use of, 519
Tyndaridae, 125, 129
- usurers, 383
- vagrants, 55
Veranius, Q., 369
vinegar, 183
- wagons, 33, 35, 85, 145, 147, 187,
189, 211, 221
wasps, 187, 219
watches, equalization of, 117
watchword, 47, 105, 125, 131,
133, 465, 467
water, treatment of, 49, 199
water-clock, 117, 209
weddings, 53
whistling, 131
women, use of as patrols, 197
wrestler, simile of, 511
- Zeus the Saviour, 129

THE LOEB CLASSICAL LIBRARY

VOLUMES ALREADY PUBLISHED

LATIN AUTHORS

- AMMIANUS MARCELLINUS. J. C. Rolfe. 3 Vols.
(Vols. I. and II. *2nd Imp. revised.*)
- APULEIUS. THE GOLDEN ASS (METAMORPHOSES). W. Adlington (1566). Revised by S. Gaselee. (*7th Imp.*)
- ST. AUGUSTINE, CONFESSIONS OF. W. Watt (1631). 2 Vols. (Vol. I. *6th Imp.*, Vol. II. *5th Imp.*)
- ST. AUGUSTINE, SELECT LETTERS. J. H. Baxter.
- AUSONIUS. H. G. Evelyn White. 2 Vols. (Vol. II. *2nd Imp.*)
- BEDE. J. E. King. 2 Vols.
- BOETHIUS: TRACTS AND DE CONSOLATIONE PHILOSOPHIAE. Rev. H. F. Stewart and E. K. Rand. (*4th Imp.*)
- CAESAR: CIVIL WARS. A. G. Peskett. (*4th Imp.*)
- CAESAR: GALIC WAR. H. J. Edwards. (*9th Imp.*)
- CATO AND VARRO: DE RE RUSTICA. H. B. Ash and W. D. Hooper. (*2nd Imp.*)
- CATULLUS. F. W. Cornish; TIBULLUS. J. B. Postgate; AND PERVIGILIIUM VENERIS. J. W. Mackail. (*11th Imp.*)
- CELSUS: DE MEDICINA. W. G. Spencer. 3 Vols. (Vol. I. *3rd Imp. revised.*)

THE LOEB CLASSICAL LIBRARY

- CICERO: BRUTUS AND ORATOR. G. L. Hendrickson and H. M. Hubbell. (2nd Imp.)
- CICERO: DE FATO; PARADOXA STOICORUM; DE PARTITIONE ORATORIA. H. Rackham. (With De Oratore, Vol. II.) (2nd Imp.)
- CICERO: DE FINIBUS. H. Rackham. (3rd Imp. revised.)
- CICERO: DE NATURA DEORUM AND ACADEMICA. H. Rackham.
- CICERO: DE OFFICIIS. Walter Miller. (4th Imp.)
- CICERO: DE ORATORE. F. W. Sutton and H. Rackham. 2 Vols. (2nd Imp.)
- CICERO: DE REPUBLICA AND DE LEGIBUS. Clinton W. Keyes. (3rd Imp.)
- CICERO: DE SENECTUTE, DE AMICITIA, DE DIVINATIONE. W. A. Falconer. (5th Imp.)
- CICERO: IN CATILINAM, PRO MURENA, PRO SULLA, PRO FLACCO. Louis E. Lord. (2nd Imp. revised.)
- CICERO: LETTERS TO ATTICUS. E. O. Winstedt. 3 Vols. (Vol. I. 6th Imp., Vols. II. and III. 3rd Imp.)
- CICERO: LETTERS TO HIS FRIENDS. W. Glynn Williams. 3 Vols. (Vols. I. and II. 2nd Imp.)
- CICERO: PHILIPPICS. W. C. A. Ker. (2nd Imp.)
- CICERO: PRO ARCHIA, POST REDITUM, DE DOMO, DE HARUSPICUM RESPONSIS, PRO PLANCIO. N. H. Watts. (2nd Imp.)
- CICERO: PRO CAECINA, PRO LEGE MANILIA, PRO CLUENTIO, PRO RABIRIO. H. Grose Hodge. (2nd Imp.)
- CICERO: PRO MILONE, IN PISONEM, PRO SCAURO, PRO FONTEIO, PRO RABIRIO POSTUMO, PRO MARCELLO, PRO LIGARIO, PRO REGE DEIOTARO. N. H. Watts.
- CICERO: PRO QUINCTIO, PRO ROSCIO AMERINO, PRO ROSCIO COMOEDO, CONTRA RULLUM. J. H. Freese. (2nd Imp.)
- CICERO: TUSCULAN DISPUTATIONS. J. E. King. (2nd Imp.)
- CICERO: VERRINE ORATIONS. L. H. G. Greenwood. 2 Vols. (Vol. I. 2nd Imp.)
- CLAUDIAN. M. Platnauer. 2 Vols.

THE LOEB CLASSICAL LIBRARY

- COLUMELLA : DE RE RUSTICA. H. B. Ash. 2 Vols.
Vol. I. Books I.-IV. (2nd Imp.)
- CURTIUS, Q. : HISTORY OF ALEXANDER. J. C. Rolfe. 2 Vols.
- FLORUS. E. S. Forster ; and CORNELIUS NEPOS. J. C. Rolfe. (2nd Imp.)
- FRONTINUS : STRATAGEMS AND AQUEDUCTS. C. E. Bennett and M. B. McElwain. (2nd Imp.)
- FRONTO : CORRESPONDENCE. C. R. Haines. 2 Vols.
- GELLIUS. J. C. Rolfe. 3 Vols. (Vols. I. and II. 2nd Imp.)
- HORACE : ODES AND EPODES. C. E. Bennett. (13th Imp. revised.)
- HORACE : SATIRES, EPISTLES, ARS POETICA. H. R. Fairclough. (8th Imp. revised.)
- JEROME : SELECT LETTERS. F. A. Wright.
- JUVENAL AND PERSIUS. G. G. Ramsay. (6th Imp.)
- LIVY. B. O. Foster, F. G. Moore, Evan T. Sage and A. C. Schlesinger. 13 Vols. Vols. I.-VII., IX.-XII. (Vol. I. 3rd Imp., Vols. II.-V., VII., IX.-XII. 2nd Imp. revised.)
- LUCAN. J. D. Duff. (2nd Imp.)
- LUCRETIVS. W. H. D. Rouse. (6th Imp. revised.)
- MARTIAL. W. C. A. Ker. 2 Vols. (Vol. I. 5th Imp., Vol. II. 3rd Imp. revised.)
- MINOR LATIN POETS : from PUBLIUS SYRUS to RUTILIUS NAMATIANS, including GRATIUS, CALPURNIUS SICULUS, NEMESIANUS, AVIANUS, with "Aetna," "Phoenix" and other poems. J. Wight Duff and Arnold M. Duff. (2nd Imp.)
- OVID : THE ART OF LOVE AND OTHER POEMS. J. H. Mozley. (3rd Imp.)
- OVID : FASTI. Sir James G. Frazer.
- OVID : HEROIDES AND AMORES. Grant Showerman. (4th Imp.)
- OVID : METAMORPHOSES. F. J. Miller. 2 Vols. (Vol. I. 9th Imp., Vol. II. 7th Imp.)
- OVID : TRISTIA AND EX PONTO. A. L. Wheeler. (2nd Imp.)
- PETRONIUS. M. Heseltine ; SENECA : APOCOLO-CYNTOSIS. W. H. D. Rouse. (7th Imp. revised.)
- PLAUTUS. Paul Nixon. 5 Vols. (Vols. I. and II. 4th Imp., Vol. III. 3rd Imp.)
- PLINY : LETTERS. Melmoth's Translation revised by

THE LOEB CLASSICAL LIBRARY

- W. M. L. Hutchinson. 2 Vols. (Vol. I. *5th Imp.*, Vol. II. *4th Imp.*)
- PLINY: NATURAL HISTORY. H. Rackham and W. H. S. Jones. 10 Vols. Vols. I.-IV. (Vols I.-III. *2nd Imp.*)
- PROPERTIUS. H. E. Butler. (*5th Imp.*)
- QUINTILIAN. H. E. Butler. 4 Vols. (*2nd Imp.*)
- REMAINS OF OLD LATIN. E. H. Warmington. 4 Vols. Vol. I. (Ennius and Caecilius). Vol. II. (Livius, Naevius, Pacuvius, Accius). Vol. III. (Lucilius, Laws of the XII Tables). Vol. IV. (Archaic Inscriptions). (Vol. IV. *2nd Imp.*)
- SALLUST. J. C. Rolfe. (*3rd Imp. revised.*)
- SCRIPTORES HISTORIAE AUGUSTAE. D. Magie. 3 Vols. (Vol. I. *2nd Imp. revised.*)
- SENECA: APOCLOCYNTOSIS. Cf. PETRONIUS.
- SENECA: EPISTULAE MORALES. R. M. Gummere. 3 Vols. (Vol. I. *3rd Imp.*, Vols. II. and III. *2nd Imp. revised.*)
- SENECA: MORAL ESSAYS. J. W. Basore. 3 Vols. (Vol. II. *3rd Imp. revised.*, Vol. III. *2nd Imp. revised.*)
- SENECA: TRAGEDIES. F. J. Miller. 2 Vols. (Vol. I. *3rd Imp.*, Vol. II. *2nd Imp. revised.*)
- SIDONIUS: POEMS AND LETTERS. W. B. Anderson. 2 Vols. Vol. I.
- SILIUS ITALICUS. J. D. Duff. 2 Vols. (Vol. I. *2nd Imp.*, Vol. II. *3rd Imp.*)
- STATIUS. J. H. Mozley. 2 Vols.
- SUETONIUS. J. C. Rolfe. 2 Vols. (Vol. I. *6th Imp.*, Vol. II. *5th Imp.*)
- TACITUS: DIALOGUS. Sir Wm. Peterson; and AGRICOLA AND GERMANIA. Maurice Hutton. (*6th Imp.*)
- TACITUS: HISTORIES AND ANNALS. C. H. Moore and J. Jackson. 4 Vols. (Vols. I. and II. *2nd Imp.*)
- TERENCE. John Sargeant. 2 Vols. (Vol. I. *6th Imp.*, Vol. II. *5th Imp.*)
- TERTULLIAN: APOLOGIA AND DE SPECTACULIS. T. R. Glover; MINUCIUS FELIX. G. H. Rendall.
- VALERIUS FLACCUS. J. H. Mozley. (*2nd Imp. revised.*)
- VARRO: DE LINGUA LATINA. R. G. Kent. 2 Vols. (*2nd Imp.*)
- VELLEIUS PATERCULUS AND RES GESTAE DIVI AUGUSTI. F. W. Shipley.

THE LOEB CLASSICAL LIBRARY

- VIRGIL. H. R. Fairclough. 2 Vols. (Vol. I. 16th Imp.,
Vol. II. 13th Imp. revised.)
VITRUVIUS: DE ARCHITECTURA. F. Granger.
2 Vols. (Vol. I. 2nd Imp.)

GREEK AUTHORS

- ACHILLES TATIUS. S. Gaselee. (2nd Imp.)
AENEAS TACTICUS, ASCLEPIODOTUS AND ONASANDER. The Illinois Greek Club. (2nd Imp.)
AESCHINES. C. D. Adams. (2nd Imp.)
AESCHYLUS. H. Weir Smyth. 2 Vols. (Vol. I. 5th Imp.,
Vol. II. 4th Imp.)
APOLLODORUS. Sir James G. Frazer. 2 Vols. (2nd Imp.)
APOLLONIUS RHODIUS. R. C. Seaton. (4th Imp.)
THE APOSTOLIC FATHERS. Kirsopp Lake. 2 Vols.
(Vol. I. 7th Imp., Vol. II. 6th Imp.)
APPIAN'S ROMAN HISTORY. Horace White. 4 Vols.
(Vol. I. 3rd Imp., Vols. II., III. and IV. 2nd Imp.)
ARATUS. Cf. CALLIMACHUS.
ARISTOPHANES. Benjamin Bickley Rogers. 3 Vols.
(4th Imp.) Verse trans.
ARISTOTLE: ART OF RHETORIC. J. H. Freese.
(3rd Imp.)
ARISTOTLE: ATHENIAN CONSTITUTION, EUDEMIAN ETHICS, VIRTUES AND VICES. H. Rackham.
(2nd Imp.)
ARISTOTLE: GENERATION OF ANIMALS. A. L. Peck. (2nd Imp.)
ARISTOTLE: METAPHYSICS. H. Tredennick. 2 Vols.
(3rd Imp.)
ARISTOTLE: MINOR WORKS. W. S. Hett. ON COLOURS, ON THINGS HEARD, PHYSIOGNOMICS, ON PLANTS, ON MARVELLOUS THINGS HEARD, MECHANICAL PROBLEMS, ON INDIVISIBLE LINES, SITUATIONS AND NAMES OF WINDS, ON MELISSUS, XENOPHANES, AND GORGIAS.
ARISTOTLE: NICOMACHEAN ETHICS. H. Rackham. (5th Imp. revised.)
ARISTOTLE: OECONOMICA AND MAGNA MORALIA. G. C. Armstrong. (With Metaphysics, Vol. II.)
(3rd Imp.)

THE LOEB CLASSICAL LIBRARY

- ARISTOTLE: ON THE HEAVENS. W. K. C. Guthrie.
(2nd Imp.)
- ARISTOTLE: ON THE SOUL, PARVA NATURALIA,
ON BREATH. W. S. Hett. (2nd Imp. revised.)
- ARISTOTLE: ORGANON. H. P. Cooke and H. Tredennick. 3 Vols. Vol. I. (2nd Imp.)
- ARISTOTLE: PARTS OF ANIMALS. A. L. Peck;
MOTION AND PROGRESSION OF ANIMALS.
E. S. Forster. (2nd Imp.)
- ARISTOTLE: PHYSICS. Rev. P. Wicksteed and F. M. Cornford. 2 Vols. (2nd Imp.)
- ARISTOTLE: POETICS AND LONGINUS. W. Hamilton Fyfe; DEMETRIUS ON STYLE. W. Rhys Roberts. (4th Imp. revised.)
- ARISTOTLE: POLITICS. H. Rackham. (3rd Imp.)
- ARISTOTLE: PROBLEMS. W. S. Hett. 2 Vols. (Vol. I. 2nd Imp. revised.)
- ARISTOTLE: RHETORICA AD ALEXANDRUM.
H. Rackham. (With Problems, Vol. II.)
- ARRIAN: HISTORY OF ALEXANDER AND INDICA.
Rev. E. Iliffe Robson. 2 Vols. (2nd Imp.)
- ATHENAÆUS: DEIPNOSOPHISTAE. C. B. Gulick.
7 Vols. (Vols I., V. and VI. 2nd Imp.)
- ST. BASIL: LETTERS. R. J. Deferrari. 4 Vols. (Vols. I., II. and IV. 2nd Imp.)
- CALLIMACHUS AND LYCOPHRON. A. W. Mair;
ARATUS. G. R. Mair.
- CLEMENT OF ALEXANDRIA. Rev. G. W. Butterworth.
(2nd Imp.)
- COLLUTHIUS. Cf. OPPIAN.
- DAPHNIS AND CHLOE. Cf. LONGUS.
- DEMOSTHENES II.: DE CORONA AND DE FALSA
LEGATIONE. C. A. Vince and J. H. Vince. (2nd
Imp. revised.)
- DEMOSTHENES III.: MEIDIAS, ANDROTION,
ARISTOCRATES, TIMOCRATES, ARISTOGEITON.
J. H. Vince.
- DEMOSTHENES I.: OLYNTHIACS, PHILIPPICS AND
MINOR ORATIONS: I.-XVII. AND XX. J. H.
Vince.
- DEMOSTHENES IV.-VI.: PRIVATE ORATIONS AND
IN NEAERAM. A. T. Murray. (Vol. IV. 2nd Imp.)

THE LOEB CLASSICAL LIBRARY

- DIO CASSIUS: ROMAN HISTORY. E. Cary. 9 Vols.
(Vols. I. and II. *2nd Imp.*)
- DIO CHRYSOSTOM. 5 Vols. Vols. I. and II. J. W. Cohoon. Vol. III. J. W. Cohoon and H. Lamar Crosby. Vol. IV. H. Lamar Crosby. (Vols. I. and II. *2nd Imp.*)
- DIODORUS SICULUS. 12 Vols. Vols. I.-IV. C. H. Oldfather. Vol. IX. Russel M. Geer. (Vol. I. *2nd Imp.*)
- DIODEGENES LAERTIUS. R. D. Hicks. 2 Vols. (Vol. I. *3rd Imp.*, Vol. II. *2nd Imp.*)
- DIONYSIUS OF HALICARNASSUS: ROMAN ANTIQUITIES. Spelman's translation revised by E. Cary. 7 Vols. Vols. I.-VI. (Vol. IV. *2nd Imp.*)
- EPICTETUS. W. A. Oldfather. 2 Vols. (Vol. I. *2nd Imp.*)
- EURIPIDES. A. S. Way. 4 Vols. (Vols. I., II. and IV. *6th Imp.*, Vol. III. *5th Imp.*) Verse trans.
- EUSEBIUS: ECCLESIASTICAL HISTORY. Kirszopp Lake and J. E. L. Oulton. 2 Vols. (Vol. I. *2nd Imp.*, Vol. II. *3rd Imp.*)
- GALEN: ON THE NATURAL FACULTIES. A. J. Brock. (*3rd Imp.*)
- THE GREEK ANTHOLOGY. W. R. Paton. 5 Vols. (Vols. I. and II. *4th Imp.*, Vols. III. and IV. *3rd Imp.*)
- THE GREEK BUCOLIC POETS (THEOCRITUS, BION, MOSCHUS). J. M. Edmonds. (*6th Imp. revised.*)
- GREEK ELEGY AND IAMBUS WITH THE ANACREONTEA. J. M. Edmonds. 2 Vols. (Vol. I. *2nd Imp.*)
- GREEK MATHEMATICAL WORKS. Ivor Thomas. 2 Vols. (*2nd Imp.*)
- HERODES. Cf. THEOPHRASTUS: CHARACTERS.
- HERODOTUS. A. D. Godley. 4 Vols. (Vol. I. *4th Imp.*, Vols. II.-IV. *3rd Imp.*)
- HESIOD AND THE HOMERIC HYMNS. H. G. Evelyn White. (*6th Imp. revised and enlarged.*)
- HIPPOCRATES AND THE FRAGMENTS OF HERACLEITUS. W. H. S. Jones and E. T. Withington. 4 Vols. (Vol. I. *3rd Imp.*, Vols. II.-IV. *2nd Imp.*)
- HOMER: ILIAD. A. T. Murray. 2 Vols. (*6th Imp.*)
- HOMER: ODYSSEY. A. T. Murray. 2 Vols. (*7th Imp.*)
- ISAEUS. E. S. Forster. (*2nd Imp.*)
- ISOCRATES. George Norlin and LaRue Van Hook. 3 Vols.
- ST. JOHN DAMASCENE: BARLAAM AND IOA-

THE LOEB CLASSICAL LIBRARY

- SAPH. Rev. G. R. Woodward and Harold Mattingly.
(*2nd Imp. revised.*)
- JOSEPHUS. H. St. J. Thackeray and Ralph Marcus.
9 Vols. Vols. I.-VII. (Vols. I., V. and VI. *2nd Imp.*)
- JULIAN. Wilmer Cave Wright. 3 Vols. (Vol. I. *2nd Imp.*,
Vol. II. *3rd Imp.*)
- LONGUS: DAPHNIS AND CHLOE. Thornley's Trans-
lation revised by J. M. Edmonds; AND PARTHENIUS.
S. Gaselee. (*3rd Imp.*)
- LUCIAN. A. M. Harmon. 8 Vols. Vols. I.-V. (Vols. I.
and II. *2nd Imp.*, Vol. III. *3rd Imp.*)
- LYCOPHRON. Cf. CALLIMACHUS.
- LYRA GRAECA. J. M. Edmonds. 3 Vols. (Vol. I.
3rd Imp., Vol. II. *2nd Ed. revised and enlarged*, Vol. III.
3rd Imp. revised.)
- LYSIAS. W. R. M. Lamb. (*2nd Imp.*)
- MANETHO. W. G. Waddell. PTOLEMY: TETRA-
BIBLOS. F. E. Robbins. (*2nd Imp.*)
- MARCUS AURELIUS. C. R. Haines. (*3rd Imp. revised.*)
- MENANDER. F. G. Allinson. (*2nd Imp. revised.*)
- MINOR ATTIC ORATORS. 2 Vols. Vol. I. ANTI-
PHON, ANDOCIDES. K. J. Maidment.
- NONNOS: DIONYSIACA. W. H. D. Rouse. 3 Vols.
(Vol. III. *2nd Imp.*)
- OPPIAN, COLLUTHUS, TRYPHIODORUS. A. W. Mair.
- PAPYRI. NON-LITERARY SELECTIONS. A. S.
Hunt and C. C. Edgar. 2 Vols. (Vol. I. *2nd Imp.*)
- LITERARY SELECTIONS. Vol. I. (Poetry). D. L.
Page. (*2nd Imp.*)
- PARTHENIUS. Cf. LONGUS.
- PAUSANIAS: DESCRIPTION OF GREECE. W. H. S.
Jones. 5 Vols. and Companion Vol. arranged by R. E.
Wycherley. (Vols. I. and III. *2nd Imp.*)
- PHILO. 11 Vols. Vols. I.-V. F. H. Colson and Rev. G. H.
Whitaker; Vols. VI.-IX. F. H. Colson. (Vols. I., II., V.,
VI. and VII. *2nd Imp.*, Vol. IV. *3rd Imp. revised.*)
- PHILOSTRATUS: THE LIFE OF APOLLONIUS OF
TYANA. F. C. Conybeare. 2 Vols. (*3rd Imp.*)
- PHILOSTRATUS; IMAGINES; CALLISTRATUS:
DESCRIPTIONS. A. Fairbanks.
- PHILOSTRATUS AND EUNAPIUS: LIVES OF THE
SOPHISTS. Wilmer Cave Wright. (*2nd Imp.*)

THE LOEB CLASSICAL LIBRARY

- PINDAR. Sir J. E. Sandys. (*7th Imp. revised.*)
- PLATO: CHARMIDES, ALCIBIADES, HIPPARCHUS,
THE LOVERS, THEAGES, MINOS AND EPINOMIS.
W. R. M. Lamb.
- PLATO: CRATYLUS, PARMENIDES, GREATER
HIPPIAS, LESSER HIPPIAS. H. N. Fowler. (*3rd
Imp.*)
- PLATO: EUTHYPHRO, APOLOGY, CRITO, PHAE-
DO, PHAEDRUS. H. N. Fowler. (*9th Imp.*)
- PLATO: LACHES, PROTAGORAS, MENO, EUTHY-
DEMUS. W. R. M. Lamb. (*2nd Imp. revised.*)
- PLATO: LAWS. Rev. R. G. Bury. 2 Vols. (*2nd Imp.*)
- PLATO: LYSIS, SYMPOSIUM, GORGIAS. W. R. M.
Lamb. (*4th Imp. revised.*)
- PLATO: REPUBLIC. Paul Shorey. 2 Vols. (Vol. I.
4th Imp., Vol. II. *3rd Imp.*)
- PLATO: STATESMAN, PHILEBUS. H. N. Fowler;
ION. W. R. M. Lamb. (*3rd Imp.*)
- PLATO: THEAETETUS AND SOPHIST. H. N. Fowler.
(*3rd Imp.*)
- PLATO: TIMAEUS, CRITIAS, CLITOPHO, MENEXE-
NUS, EPISTULAE. Rev. R. G. Bury. (*2nd Imp.*)
- PLUTARCH: MORALIA. 14 Vols. Vols. I.-V. F. C.
Babbitt; Vol. VI. W. C. Helmbold; Vol. X. H. N.
Fowler. (Vols. I., III., and X. *2nd Imp.*)
- PLUTARCH: THE PARALLEL LIVES. B. Perrin. 11
Vols. (Vols. I., II. and VII. *3rd Imp.*, Vols. III., IV.,
VI., VIII.-XI. *2nd Imp.*)
- POLYBIUS. W. R. Paton. 6 Vols.
- PROCOPIUS: HISTORY OF THE WARS. H. B.
Dewing. 7 Vols. (Vol. I. *2nd Imp.*)
- PTOLEMY: TETRABIBLOS. Cf. MANETHO.
- QUINTUS SMYRNAEUS. A. S. Way. Verse trans.
(*2nd Imp.*)
- SEXTUS EMPIRICUS. Rev. R. G. Bury. 4 Vols. Vols.
I.-III. (Vols. I. and III. *2nd Imp.*)
- SOPHOCLES. F. Storr. 2 Vols. (Vol. I. *8th Imp.*, Vol.
II. *5th Imp.*) Verse trans.
- STRABO: GEOGRAPHY. Horace L. Jones. 8 Vols.
(Vols. I. and VIII. *3rd Imp.*, Vols. II., V. and VI. *2nd Imp.*)
- THEOPHRASTUS: CHARACTERES. J. M. Edmonds;
HERODES, etc. A. D. Knox. (*2nd Imp.*)

THE LOEB CLASSICAL LIBRARY

- THEOPHRASTUS: ENQUIRY INTO PLANTS. Sir Arthur Hort. 2 Vols. (2nd Imp.)
THUCYDIDES. C. F. Smith. 4 Vols. (Vol. I. 3rd Imp., Vols. II., III. and IV. 2nd Imp. revised.)
TRYPHIODORUS. Cf. OPIAN.
XENOPHON: CYROPAEDIA. Walter Miller. 2 Vols. (Vol. I. 2nd Imp., Vol. II. 3rd Imp.)
XENOPHON: HELLENICA, ANABASIS, APOLOGY, AND SYMPOSIUM. C. L. Brownson and O. J. Todd. 3 Vols. (3rd Imp.)
XENOPHON: MEMORABILIA AND OECONOMICUS. E. C. Marchant. (2nd Imp.)
XENOPHON: SCRIPTA MINORA. E. C. Marchant. (2nd Imp.)
-

VOLUMES IN PREPARATION

GREEK AUTHORS

- ALCIPHON. A. R. Benner and F. H. Fobes.
ARISTOTLE: DE MUNDO, etc. A. L. Peck and E. S. Forster.
ARISTOTLE: HISTORY OF ANIMALS. A. L. Peck.
ARISTOTLE: METEOROLOGICA. H. D. P. Lee.
DEMOSTHENES: EPISTLES, etc. N. W. and N. J. DeWitt.
PLOTINUS.

LATIN AUTHORS

- S. AUGUSTINE: CITY OF GOD.
[CICERO:] AD HERENNIIUM. H. Caplan.
CICERO: DE INVENTIONE. H. M. Hubbell.
CICERO: PRO SESTIO, IN VATINIUM, PRO CAELIO, DE PROVINCIIS CONSULARIBUS, PRO BALBO. J. H. Freese and R. Gardner.
PHAEDRUS AND OTHER FABULISTS. B. E. Perry.
PRUDENTIUS. H. J. Thomson.

DESCRIPTIVE PROSPECTUS ON APPLICATION

CAMBRIDGE, MASS.
HARVARD UNIV. PRESS
Cloth \$2.50

LONDON
WILLIAM HEINEMANN LTD
Cloth 10s.

